



Table of Contents

Welcome to Michigan GreenStar	5
Overall Prerequisites.....	10
1_Pre-construction_Design_Strategies.....	42
1A - Integrated Project Team.....	43
1B -DESIGN	45
1C - HOME SIZE.....	59
2 Site & Landscape	62
2PR- Perquisites	62
2A -SOIL AND PERMIABILITY	64
2B - PLANTING/TREES	68
2C - IRRIGATION	80
2D - DECKS, PATIOS AND PORCHES	85
2E - EROSION CONTROL	89
2F - RAINWATER HARVEST	94
2G-GRADING/DRAINAGE.....	97
Introduction to 3 & 4.....	102
Introduction to High Performance Floor, Wall, Ceiling and Roof Assemblies.....	102
3 Improvements to Existing Floor, Wall, Ceiling & Roof Assemblies.....	107
3PR -PREREQUISITES.....	108
3A - AIR TIGHTNESS	118
3B - Improvements to Existing Foundations, Crawl Spaces, and Slab Floor Assemblies	128

[Thank You Sponsors - Together We Improve Homes & People's Lives](#)



3C - Improvements To All Existing Above Grade Walls, Ceilings and Non-Slab (framed) Floors	140
3D - Improvements To Existing Windows, Skylights and Doors.....	159
3E -Improvements To Existing Attics That Are Remaining Unfinished	176
3F - Finishing Unfinished Attics.....	182
3G - Improvements To Finished Attics and Roofs.....	195
4 New Floor, Wall, Ceiling & Roof Assemblies	210
4PR - Prerequisites	210
4A - Air Tightness.....	213
4B - New Foundations, Crawl Spaces, and Slab Floor Assemblies.....	213
4C -New Exterior Walls Above Grade, All New Non-Slab (framed) Floors, All New Interior Partition Walls and All New Ceilings	234
4D - New Windows, Skylights and Doors	249
4E - New attics and roof additions recommendation	263
5 MECHANICALS.....	280
5PR -Prerequisites	280
5A -Ventilation and Fresh Air for Occupants	290
5B -Moisture and Relative Humidity	300
5C- HVAC DISTRIBUTION STRATEGIES	304
5D- Heating and cooling equipment	317
5E- Miscellaneous Mechanical.....	327
6 ELECTRICAL	330
6PR -Prerequisites	330
6A- Appliances.....	332
6B-Fans, fixtures and lights	341
6C- WIRING.....	355
6D- Electrical Systems.....	357
7 Water - Plumbing, Systems & Fixtures	360

[Thank You Sponsors - Together We Improve Homes & People's Lives](#)



7A- Equipment.....	361
7B-Fixtures.....	365
7C-Piping.....	376
7D-Water Systems.....	381
8 Interior Finish & Coatings.....	386
8PR-Prerequisites.....	392
8A- Wall and Ceiling Materials.....	395
8B-Flooring.....	402
8C-Millwork and Doors.....	411
8D- Countertops.....	417
8E- Cabinetry.....	421
8F-Coatings and Adhesives.....	424
9_Waste_Management.....	427
9A -Construction and Demolition Waste.....	428
9B -Homeowner Waste Reduction.....	446
10 Education.....	448
10PR -Prerequisites.....	449
10A -Homeowner and Subcontractor Education.....	449
11 Innovation.....	453
11PR -Prerequisites.....	453
11A- Performance Design and Alternative Methods.....	453
11B -Design for Reduced Electrical and Magnetic Fields.....	457
11C -Innovative Design.....	473

[Thank You Sponsors - Together We Improve Homes & People's Lives](#)



[Thank You Sponsors - Together We Improve Homes & People's Lives](#)



Welcome and thank you for choosing to use MI GreenStar to certify your next home/remodeling project. MI GreenStar was designed to help you navigate the complex world of Green building to ensure that your home/project is built Green.

MI GreenStar defines Green building as the application of the five key concepts of Green to the traditional building practice for the purpose of improving the life of the occupant and the impact of the home on the occupant, the surrounding community, and the environment.

The five key concepts that govern Green building are: resource efficiency, water conservation, indoor environmental quality, site and community impact and energy efficiency. These five concepts are all considered to have equal weight in the process and the potential for impact on the home and the community. In the MI GreenStar program these five concepts are abbreviated as follows: RE (Resource Efficiency), WC (Water Conservation), IEQ (Indoor Environmental Quality), SC (Site and Community Impact), and EE (Energy Efficiency).

The MI GreenStar certification program is designed to ease the process of determining what is Green and how to evaluate it. The primary tool used to do this is the MI GreenStar Checklist which can be downloaded from the MI GreenStar website. It is an interactive Excel spreadsheet that is meant to remain in electronic form as long as possible to reduce consumption of resources. The checklist is comprised of strategies that you may choose to employ in your project. Each strategy is followed by five columns labeled EE, RE, IEQ, WC, SC that contain the point or points that are applicable to that strategy.

The second tool that has been developed to help facilitate the Green building process is this User's Manual. Each strategy that appears in the checklist also appears in this manual with an explanation of the credit, the intent, any exceptions that might apply, and some considerations that should be taken into account when implementing that strategy. We have also included some resource information periodically to help you understand and research more about a particular building system, technology, or conservation strategy.

The manual is divided up into chapters that mirror the sections in the checklist. Each section has an introduction which we recommend reading prior to filling out the

[Thank You Sponsors - Together We Improve Homes & People's Lives](#)

checklist as it may give you insight into how some of the strategies were conceived, or help you understand why certain strategies are encouraged more than others. Some subsections will have a brief explanation of the subsequent credits.

The user manual was not intended to be read straight through credit by credit. Rather, when choosing credits in the checklist, refer back to the manual to see if there are any exceptions or considerations that might affect your project. Major themes and concepts may be captured both in the introduction and in the subsequent relevant credits. You may need to refer to the beginning of a section for a comprehensive explanation of the theme. Some of the requirements that should be reviewed prior to filing out the checklist are those surrounding radon mitigation, and recessed light installation.

Green building is an ever evolving subject of study and revelation. New insights into building performance, material impact and durability, better life cycle analysis tools, and a better understanding of the world around us as it changes, are constantly being reviewed and incorporated into the MI GreenStar program. Our intent is that this program and these documents continue to grow and evolve over the coming years with input from those who are using the program.

We are also aware that there are imperfections in the program and the checklist. There may be strategies that you do not see listed or technologies that are not credited. Some of these may have been deemed not worthy of recognition in our climate or may have developed since the latest update to the checklist and user's manual were made. We encourage you to submit strategies or products for review using our strategy/product review forms available on our website.

If you have an innovative solution or unusual condition that either does not fit within one of our strategies, or is missing from the program, you are asked to complete an innovation credit request form and submit it with your project application.

Thank you once again for selecting MI GreenStar to help ensure that your next remodeling project is built Green.

Sincerely,
GreenStar Team

[Thank You Sponsors - Together We Improve Homes & People's Lives](#)

Acknowledgements

MI GreenStar is the quintessential grass-roots story that begins with the creation of the Minnesota Green Remodeling Program, upon which the MI GreenStar Program is based. The Minnesota program was initiated by the ad hoc Green Remodeling Group that quickly partnered with The Green Institute and the University of Minnesota's Center for Sustainable Building Research to develop the the Mn GreenStar Remodeling program. The program was primarily by a large and diverse group of volunteers for the purpose of changing our built environment and creating meaningful change in our building process, both programs are the result of countless hours of dedicated hard-work and sacrifice.

Without the support of the following organizations, MN GreenStar would not have made it as far as it has: The Green Institute, which provided financial support, resources, expertise and balance. The National Association of the Remodeling Industry - Minnesota Chapter, which provided volunteers, staff support, expertise and perspective. And, the Minnesota Pollution Control Agency which provided the financial support for the program development and trainings for the original MN GreenStar participants, and support in introducing the program to cities around the state of MN. Finally, the Alliance for Environmental Sustainability (AES), which has played a huge role in tailoring the MN Green Remodeling Program to make Green Remodeling Certification available in an ever expanding list of states outside of Minnesota, Michigan being one of them.

The individuals who make up the board of directors of MN GreenStar and AES, present and future, are to be thanked for their time and support of programs that seek to do the right thing and ensure that MI GreenStar continues to be the benchmark for Green Remodeling in Michigan.

Our great and humble thanks to these individuals and companies who made this possible:

- Michael Ansel
- Marc Sloom
- Mark Spiers
- Stephen Roche
- Ben Shardlow
- Josh Crenshaw
- Sean Morrissey
- Ishmael Israel
- Matt Danielson
- Don Shelby
- Peter Jacobson
- Janneke Schaap
- Michael Holcomb
- Brett Little
- Jamison Lenz
- Jason LaFluer
- Erin Barnes-Driscoll
- Todd Bjerstedt
- Christine Bleyhl
- Corey Brinkema
- Rick Carter
- KC Chermak
- Bob Engstrom
- Dylan Howard
- Christopher Jones
- Dave Klun
- Joe Kneable
- Jonee Kulman-Brigham
- Laura Millberg
- Bruce Nelson
- Shawn Nelson
- Cindy Ojczyk
- Harvey Sherman
- Phil Smith
- Ron Smith
- Dave Welsch
- Better Homes & Garbage
- Building Arts Sustainable Architecture+Construction LLC
- Carl Seville
- Center for Sustainable Building Research at the University of Minnesota
- Cindy Ojczyk Design
- David Eisenberg
- David Johnston
- Dovetail Partners, LLC
- Great River Energy
- Kestrel Design Group
- Manomin Hardwood Floors
- Minnesota Department of Commerce
- Mississippi Headwaters Chapter of the U.S. Green Building Council
- New Spaces Design-Build
- Otogawa-Ansel Design-Build
- SALA Architects, Inc.
- Scherer Brothers Lumber Company
- Shaw/Stewart Lumber Company
- The Remodeler's Choice
- Vujovich Design-Build
- Xcel Energy

[Thank You Sponsors - Together We Improve Homes & People's Lives](#)

Green Remodeling Group

We are very excited to see the MI GreenStar program launch. We believe that there is a very real need to change the way in which we deal with our existing housing stock and its impact on the lives of the occupants and the environment. We believe that existing homes are one of the primary culprits for energy consumption and wasteful practices. It is our hope that remodelers and homeowners alike will find strategies through MI GreenStar that will help them understand their role and encourage them to take some impactful steps towards improving their homes and the community in which they live.

It has been our great pleasure to work with the many wonderful organizations that make up our membership and with those that partnered with us in the development of this program.

NARI - National Association of the Remodeling Industry

The Minnesota chapter of the National Association of the Remodeling Industry is pleased to promote and support a voluntary industry initiative to create sustainable remodeling guidelines. As the premier resource of the remodeling industry, NARI of MN encourages a responsible awareness in green building practices. We view sustainability as a necessary consideration in our present remodeling solutions. Through education and with a mindful approach toward the environment, we are pleased to participate in MN GreenStar, a progressive program benefitting both the industry and the consumer.

[Thank You Sponsors - Together We Improve Homes & People's Lives](#)



Introduction to Michigan GreenStar



migreenstar

Congratulations on choosing MI GreenStar as a tool to help you design and build your remodeling project. By adhering to the guidelines of this program you can have confidence that you are using practices which are among the best in existence today. This means you can expect your MI GreenStar certified remodeling project to be more durable, better for your personal health, better for you financially, better for the community, and better for the global ecosystem.

The Remodeling Users Manual that you are reading is designed to work hand in hand with the MI GreenStar Remodeling Checklist. This manual is meant to further explain the credits listed in the checklist, and also to help educate you on many broader Green design and construction issues.

Everyone who is experienced with Green design and construction knows the importance of a holistic approach that begins with the early stages of design, and continues through construction into the long-term operation and maintenance of the home.

MI GreenStar is designed to help illuminate your path through this process to a successful Green home and tie you into a network that will help you take full advantage of all of the inherent benefits.

[Thank You Sponsors - Together We Improve Homes & People's Lives](#)



Remodeling Project Types

The Project Type categories equalize the difficulty to become certified across different project types, recognizing the fact that there are many more opportunities to score points on projects that touch more parts of the house. Contact MI GreenStar for assistance if your project does not easily fit into one of the following categories.

Type-1 _Renovations that do not add conditioned space.

Example(s):

- Finish an unfinished basement where the space being finished was already being conditioned previously, even if it was only being conditioned moderately. Most basement finishing projects would fall into this category.
- Kitchen remodel where the exterior massing of the home is not changed.
- Whole house remodel focusing on interior upgrades and new screen porch addition, even if screen porch has new foundation and/or footings, and as long as there is NO new conditioned space being added above or below the new screen porch, or anywhere else in the house.
- Other projects not listed here.

Type-2 _Renovations that add conditioned space without changing exterior shell of building.

Example(s):

- Finishing a previously unfinished attic without changing the exterior massing of the home.
- Converting an unconditioned porch into conditioned space.
- Other projects not listed here.

Type-3 _ Renovations that add conditioned space by changing the exterior shell of the building but DO NOT add new foundation and/or footings for that added space.

Example(s):

- Finishing a previously unfinished attic and changing the exterior massing by adding a dormer in the process.
- Kitchen remodel that changes the exterior massing by adding a cantilevered bay in the process.
- Other projects not listed here.

[Thank You Sponsors - Together We Improve Homes & People's Lives](#)

Special Note(s):

- Project is Type 3, even if new foundation and/or footings are added as long as they are not directly related to the addition of conditioned space. Thus new foundation and/or footings DO NOT push the project into Type 4 category if they are supporting such things as a open porch, screen porch, uninsulated enclosed porch, portico at entry, etc.

Type-4 _ Renovations that add conditioned space by changing the exterior shell of the building and add new foundation and/or footings for that added conditioned space.

Example(s):

- Kitchen remodel that changes the exterior massing by adding a bay in the process, and the new bay has a foundation and/or footings supporting it.
- Whole house remodel focusing on interior upgrades. New screen porch is also constructed, and has full basement or crawl space under it with 5' of headroom or more, and which is conditioned even minimally.
- Other projects not listed here.

Special Note(s):

- If an enclosed space is added and constructed in such a way that it is clear that the intent is that it could easily be conditioned, then it is considered conditioned space. i.e. 4 season porch constructed with insulated windows, insulated walls and insulated ceiling.

[Thank You Sponsors - Together We Improve Homes & People's Lives](#)

Overall Prerequisites

The idea behind having an Overall Prerequisites section is to highlight a few key strategies that serve as helpful reminders for every project, and to introduce the concept of prerequisites.

Each of the sections after Overall Requirements, will, in turn, have its own individual prerequisites related to the strategies in the section. The prerequisites in every section must be met in order to be considered for certification in the Michigan GreenStar program.

OPR-1_ Register with GreenStar and attend mandatory 8 hour training

Requirements:

- The person or company primarily responsible for overseeing and coordinating the certification for this project is required to submit a project registration form to GreenStar Program Administration, and pay the appropriate fees. The most current registration form and fee information can be found at the program website (www.migreenstar.org).
- Registration must occur prior to the start of construction.

Exceptions:

- None

Rationale:

- The GreenStar program is free to everyone as a guide to Green design and building. Anyone who wishes to certify their home as Green must register their intent with GreenStar, pay the appropriate GreenStar registration fee and follow the process as described in the program.

Considerations:

- None

Resources:

- www.migreenstar.org

OPR-2_ Submit all required documentation for a plan review prior to start of construction

Requirements:

- Completed checklist
- Site Plan (see OPR -5)

[Thank You Sponsors - Together We Improve Homes & People's Lives](#)

- Water Conservation Plan (see 2PR -2)
- Landscape Plan (see 2PR -3)
- Waste Management Plan (see 9PR -1)
- Construction documents
- Specifications

Exceptions:

- None

Rationale:

- Design is the critical element to building successful Green homes—those that are durable, energy, resource and water efficient, and impact homeowners and communities in a positive manner. It is difficult to build a Green home if it hasn't been designed Green from the start to be inclusive of all of the previous ideas.
- Thinking about all of the elements needed to make a Green home before construction begins, enables the homeowner, designer/architect, builder and subcontractors the opportunity to collaborate on strategies that meet design needs and Green goals within the project budget.

Considerations:

- None

Resources:

- www.migreenstar.org.

OPR-3_ Submit two year's worth of utilities bills to GreenStar (One year prior to the project, and one year after the project) See attached "Utility Tracking Table OPR-3 in the checklist.

Requirements:

- Homeowners that have not owned the home for a full year prior to the project should submit usage data for the months they have owned the home.
- Typically, it is easy to get utility data since most utility companies will provide free reports of utility usage.
- Homeowners should enter their data into the table provided in the checklist or simply submit the report provided by their utility.

Exceptions:

- None

Rationale:

- There are two reasons that utility tracking is an important Green building strategy.

[Thank You Sponsors - Together We Improve Homes & People's Lives](#)

1. Tracking utility usage is an important way for GreenStar to continue to understand the effectiveness of this program and to improve it in the future. Utility data will not be shared outside of GreenStar, nor will it be used for any other reason.
2. It is recognized that homeowners that are aware of their utility usage, are more likely to develop daily living habits that minimize wasteful utility usage.

Considerations:

- None

Resources:

- See utility company information request forms below:
******* Energy Usage & Billing Review Request Letter for Center Point Energy *******

[Thank You Sponsors - Together We Improve Homes & People's Lives](#)



Attn: Customer Service Team (fax # 507-387-1997)

I give Center Point Energy permission to fax my Energy Usage & Billing Review report to myself at the following location:

Home Office Other _____

My Fax Number is: _____

My Center Point Energy Account # is: _____

Please send as many months of my history report as you possibly can. I understand that this is typically about 18 months.

Please call my daytime phone number if you have any questions.

My Daytime Phone # is: _____

Thank You!

Printed Name: _____

Signature: _____

My Home
Address is: _____

[Thank You Sponsors - Together We Improve Homes & People's Lives](#)



OPR-4_ ENERGY STAR (or higher efficiency) rated appliances

Requirements:

- ENERGY STAR labels on all NEW appliances: clothes washers, dehumidifiers, dishwashers, refrigerators, freezers, and room air conditioners
- Do not relocate old refrigerator or freezer to basement if not already an ENERGY STAR appliance
- Recycling of old units is mandatory

Exceptions:

- Existing appliances not being replaced. If refrigerator is older than 1993, it is strongly encouraged to replace the unit.

Rationale:

- ENERGY STAR is an excellent rating system for appliances to indicate that they meet strict standards for energy efficiency.
- Appliances that pre-date 1993 and are not labeled ENERGY STAR consume an inordinate amount of energy and should not be used. Purchasing a new fridge but keeping the old one in action only serves to increase the home's overall energy consumption, which runs counter to the programs intentions.

Considerations:

- None

Resources:

- TBD

OPR-5_ Site Plan showing Major Natural Resources, Erosion Control Instructions & other project related site information such as landscape design.

Requirements:

A Site Plan which shows major natural resources, erosion control information and any other project related site information must be included with every project submitted, regardless of project scope or project size. If the project is very small, this plan may be as simple as a hand-drawn diagram with the following:

- Property Boundaries
- "North" Arrow
- Footprint of the buildings on site
- Sidewalks
- Driveways
- Patios

[Thank You Sponsors - Together We Improve Homes & People's Lives](#)

- Decks
 - Turf grass locations
 - Flower bed locations
 - Existing or proposed downspouts, if any
 - Indication of the designated staging area for materials for the project
 - Designated area for the project dumpster, if any is planned.
 - Major natural resources on site (see details below)
 - Erosion control information (see details below)
- **Major Natural Resources to be shown:**
 - Individual trees that are over 6” diameter
 - Any bodies of water or areas where water collects after rain events, snow thaws, etc.
 - **Erosion control information required on Site Plan:**
 - **Include name and phone number of the on-call sedimentation/erosion control personnel.** → This person is designated to inspect erosion control measures and repair erosion control failures during rain events that occur during non-working hours at the site. For projects that have significant site disturbance and which require silt fencing, the site should automatically be inspected by designated personnel after rain events of 1/2" or greater in any 24-hour period (a typical Michigan rainfall event will produce approximately 1/2" of rain).
 - **Location of erosion control measures needed on the site:** → Hint: Filter the checklist for all measures that have documentation due at **DESIGN**. Include additional erosion control measures as required by the project scope such as:
 - Silt fence staked around entire area of construction, site disturbance, or construction traffic flow that is not confined to paved areas.
 - Other erosion control measures may include straw bales or straw mats, and seeding areas with grasses and other plantings, etc.
 - Controlling the loose earth on site with any number of measures including dedicated traffic areas, 4-8” of wood chips, straw, silt fencing, or not excavating.
 - Tarps or similar measures to cover stock-piled soil.
 - **Location of nearby storm water gutters and storm water intakes and the protection that is planned for them:** → Nearby gutters and storm covers should be protected with silt or drainage fabric to prevent sedimentation of nearby waterways.
 - **Minimal landscape information required on Site Plan**

[Thank You Sponsors - Together We Improve Homes & People's Lives](#)

(additional landscape plan is optional):

- The site plan should contain basic landscape information on it, but if more extensive landscaping is planned, a separate drawing will most likely be necessary to communicate all of the information associated with that.
- Although GreenStar does not currently have a minimum standard for water absorption and soil disturbance, it is best for the Global Ecosystem to strive for maximum water absorption into the ground and minimal soil disturbance to the greatest extent possible.

Exceptions:

- None

Rationale:

- Drawing a site plan, even if it is relatively simple is an important step in thinking about the project within the larger context in which it exists.
- Issues related to the site plan are often overlooked, particularly the root zones of the trees on site. Even if no site work is being planned for the project, the root zones of trees may still need to be protected, since they can still be damaged by many things including:
 - material staging
 - vehicle traffic
 - insertion of underground electrical, plumbing, TV cable, etc.
 - others. . .

This damage often goes un-noticed since the dying process of trees from this kind of damage is usually over the course of many years (often up to 5 or more).

Furthermore, the very top branches are the ones that die first, and they are difficult to see from the ground.

- Water that leaves your yard and enters the sewer system is lost to both the landscape and to the aquifer deep below. Additionally, the nutrients and fertilizers that are used to nourish our yards are responsible for the impairment of our lakes and rivers and lead to algae blooms. In Minnesota, as of 2006, the PCA has determined that over 40% of our waterways are already impaired. The Minnesota River is one of the dirtiest of all the Mississippi tributaries, and the Mississippi picks up the most amount of pollution while passing through Minnesota. Keeping water on the site and allowing it to penetrate deep into the soil is the best approach to minimizing water loss, dealing with pollutants, and promoting a healthy yard with minimal irrigation.
- Soil disturbance is also a major contributor to our impaired waterways and most municipalities have strict regulation concerning the stabilization of ground soil. Before beginning construction where the soils may be disturbed, verify with the governing municipality where the building permit will be obtained to see what additional soil erosion control measures must be implemented.

[Thank You Sponsors - Together We Improve Homes & People's Lives](#)

- Rain gardens are a significant benefit to water absorption. Use plants specifically designated for rain gardens. Show on the landscape plan the location, size and technique used for rain garden design.
- Recent studies have pointed to the large volume of fresh water that is sent into the ocean each year as a contributor to the rise in sea level as well as concerns about aquifers not being replenished over time.

Considerations:

- Even though erosion control measures may be in place, over the course of a project shifts in or depletions of such measures may occur and need to be reaffixed, replanted, or replaced.
- Rain events can dislodge erosion control measures rendering them useless. Take the time to visit the site before a known event will occur, and immediately afterward to make sure the measures are in place.
- Many municipalities require erosion control measures to be in place immediately after permitting. Review erosion control requirements in the project's area.
- Always verify the location of utilities prior to digging or excavating for any reason. Contact the local utilities or see Resources below for more information.

Resources:

- Example drawings TBD.
- See these helpful resources for rain garden design, or visit a local gardening store for helpful information.
- For utility locations in the state of Minnesota, call 1 (800) 252-1166, or visit www.gopherstateonecall.org/

OPR-6_ Water conservation plan for indoors and outdoors.

Requirements:

- Indicate the water saving techniques that you plan to put in place.
- Measures you are planning to take may be related to indoor water usage, outdoor water usage or both.
- Exterior measures related to the water conservation plan could be included on the site plan.
- Interior measures related to the water conservation plan could also be listed in the margins of the site plan, or on a separate document.

[Thank You Sponsors - Together We Improve Homes & People's Lives](#)

- If there are no possible water conservation measures that can be taken due to existing conditions of the site, explain why you are unable to impact the outdoor water use as it relates to the site.

Exceptions:

- None

Rationale:

- There are often many easy, low cost measures that can be done to conserve water both indoors and outdoors. This credit is intended to encourage people to give consideration to these water saving strategies on every project during the design phase.
- Reducing the amount of potable (drinkable) water used in your house and outside of it to irrigate landscape and lawn conserves municipal water systems.
- Planting native and drought tolerant landscaping, reducing the size of lawn areas for more native plantings, and sizing and locating plants appropriately on the site are all ways to conserve site watering.
- Use rain barrels and other water catchment methods to water outdoor plants and landscaping. Installing gutters with downspouts not only moves water away from the building foundation, but also presents opportunities to use the water for irrigating plants.

Considerations:

- Potential issues with collecting roof run-off can affect plantings, depending on the composition of the roof materials. Certain plants may be damaged by roof runoff when asphalt shingles or hazardous adhesives are used.
- Water collected from asphalt roofs may not be used for watering vegetable, fruit, or herb gardens.

Resources:

- TBD

OPR-7_ Not Used

[Thank You Sponsors - Together We Improve Homes & People's Lives](#)

OPR-8_ No intentional use of Imported Forest Products on the "Controlled Imports List" unless FSC Certified. All Products from Canada are allowed without FSC Certification.

Requirements:

- Controlled Imports List (Do NOT use products listed here):
 - Imported solid sawn lumber of any species that is not FSC.
 - Imported luan that is not FSC.
 - Luan is a 1/4"-thick plywood product that is made of a core material covered in two layers of tropical mahogany or scrap wood from tropical regions.
 - Luan also deteriorates quickly in the presence of moisture so it is inadequate as an underlayment for most flooring installations.
 - "BreckenRidge" Plywood Siding.
www.roseburg.com/Product/breckenridge-siding/
- "Intentional" is defined as any product called out for use on the project drawings and/or specifications.
- Write a letter of intent to product suppliers:
Person who is responsible for ordering or purchasing materials for the project must notify all product suppliers for the project that it is their intention to not use any products on the "Controlled Imports List". Optional template letter from GreenStar is available for your convenience in the "Resources" below.
- Provide COC number for any FSC product used on the project:
Each person or company that is certified to be part of the FSC Certification process will have a Chain Of Custody (COC) number. The final seller of the product will issue a copy of their number to the purchaser.

Exceptions:

- Products from Canada are allowed.

Rationale:

- FSC, or Forest Stewardship Council, certification is an international, third-party verified process that is one of the most recognized FSC Certification processes available.
- Forest Stewardship Council Certification is a tracking system that follows the wood from the forest from which it is removed to each processing step along the way before reaching the job site.
- FSC Certification is a way to significantly reduce greenwashing associated with less-than-optimal logging and processing practices such as claiming that replanting one or more trees for every tree harvested is good environmental practice. Replanting is sound business practice for any company that wants to ensure that there is product to harvest from land in the future. But, planting a tree tells nothing about the

[Thank You Sponsors - Together We Improve Homes & People's Lives](#)

biodiversity of the forest, its ability to recover from disaster or to sustain plant and animal life, erosion control, or how illegal logging is eradicated.

- Forest Stewardship Council Certification is a process that allows all users along the path to keep track of product, logging, and harvesting practices. The goal in FSC Certification is to improve integrity in the lumber growing, extraction and delivery process to favor practices that promote sustainability.
- Canadian wood is regulated from forest to mill through government standards. While it is not FSC Certification, it is still recognized as having generally acceptable forestry practices.

Rationale Specific To Luan:

- Luan is a 1/4"-thick multilayer plywood product that is made of a core material covered in two layers of tropical mahogany or scrap wood from tropical regions. It is an inexpensive product so its use has become widespread, yet its use is problematic for several reasons.
- The use of tropical wood for building products is a contributor to the depletion of essential forests found in tropical regions of the world.
- Luan deteriorates quickly in the presence of moisture so it is inadequate as an underlayment for most flooring products.

Considerations:

- It is very difficult to track wood to its origin without Forest Stewardship Council Certification.

Resources:

- www.fsc.org
- Example letter of intent to material supplier:
TIP 1 → *Copy the content of this template letter onto your own letterhead before sending to you material supplier(s).*

TIP 2 → *If you are planning to go beyond the overall pre-requisite regarding the GreenStar "Controlled Products List" (i.e. you are planning to pursue additional credit for using FSC products as listed in Section 8 of the Checklist) then you may wish to modify the language of this letter to meet your needs more specifically.*

***** Begin example letter of intent to material supplier *****

To Whom It May Concern:

Please be aware that a significant goal on the <Insert Project Name Here> is to be as sustainable and conscientious of the Global Eco-system as possible. To this end, we are pursuing Green Building Certification through the Minnesota GreenStar program.

[Thank You Sponsors - Together We Improve Homes & People's Lives](#)

Please help us meet this goal by helping us abide by the Pre-Requisite pertaining to imported forest products. Thus it is our desire to NOT use any imported Forest Products on the GreenStar "Controlled Imports List" unless they are Forest Stewardship Council (FSC) Certified. All Products from Canada are allowed without FSC Certification.

The current "Controlled Imports List" is as follows:

(Do NOT use products listed here):

- Imported solid sawn lumber of any species that is not FSC.
- Imported luan that is not FSC.

For any FSC certified products that you do supply to us on this project, please help us fulfill our documentation requirements by including your FSC Chain Of Custody Number on the invoice.

More information about the entire GreenStar program, including the Checklist and Manual can be found at www.Migreenstar.org.

Thank you in advance for helping us be a part of a change for the better.

Sincerely,

<Insert Your Name Here>

***** End example letter of intent to material supplier *****

[Thank You Sponsors - Together We Improve Homes & People's Lives](#)



OPR-9_ No mercury thermostats—replacements must be programmable (remove/replace if pre-existing, dispose of properly)

Requirements:

- All mercury-containing thermostats must be removed and disposed of properly regardless of whether they are currently in operation. It is not allowed by this program and not legal for these to be put into the ordinary trash.
- Household items containing mercury should be taken to your county's household hazardous waste disposal site.
- Any mercury-containing thermostat that is in operation must be replaced with a non-mercury-containing replacement.
- Programmable thermostats must be programmed.



Thermostat



Thermometer

- These are examples of items that typically contain a large vial of liquid mercury.
- Fluorescent lights, which contain small amounts of mercury, are allowed.

Rationale:

- Mercury is a highly toxic substance that should be removed from our homes whenever possible.
- Thermostats that use mercury usually have a relatively large capsule of liquid mercury in them, which poses a severe health risk in the event that it became damaged and allowed to leak out.
- The thermostats that use mercury usually are much less precise than modern electronic thermostats.
- When replacing a thermostat that contains mercury, it is recommended that a programmable electronic type is used in its place. This will allow homeowners to

[Thank You Sponsors - Together We Improve Homes & People's Lives](#)

program their thermostat to automatically adjust temperature levels in the home in a way that conserves energy and does not adversely affect occupant comfort.

- The amount of mercury in fluorescent lights at this time is small, and the overall benefit to the environment through the energy saved by their use currently outweighs the potential harm from the mercury they contain.

Considerations:

- Mercury poisoning can be acute or chronic depending on the length of exposure, and type of exposure. Mercury has been found in everything from thermometers to dental fillings and even immunizations.
- Short or long exposure to mercury can lead to everything from abdominal cramping to failed memory and a depletion of IQ (intelligence quotient).

Resources:

- To find the location of the household hazardous waste facility, visit www.pca.state.mn.us/waste/hhw/index.html or call the MPCA at (651) 296-6399 (in the Twin Cities metro area) or 1 (800) 657-3864 (from outside the metro area).
- For more information about mercury visit www.pca.state.mn.us/air/mercury.html
- To learn how to recycle fluorescent lights properly visit www.lamprecycle.org/
- Some hardware stores accept used fluorescent lights from homeowners. For a list of these, visit www.earth911.org.
- Other useful sites: www.pca.state.mn.us/air/mercury-faq.html#homethermo

OPR-10_ Perform radon test in lowest possible habitable space. Mitigate if necessary.

Requirements:

- Testing for Radon must be performed regardless of the scope of work in the lowest level of the home that could be habitable in the future even if it currently is not. This includes all basements with a ceiling height of 6'-6" or greater.
- Perform the test prior to the start of construction. Ideally during the design/estimate phase of the project so that you can prepare to mitigate if required.
- Perform test using qualifying test kit. Both a 48-hour test and a 90-day test are acceptable.
- Send tests to an independent lab
- Supply GreenStar and the homeowner with a copy of the test results.
- If disturbing the site or the slab (even a little) a second test is required after completion.
- Install mitigation system if test results indicate a radon gas level, which is greater than 4 picocuries/liter.

1. Install perforated drain tile under slab or localized pocket filled with granular

[Thank You Sponsors - Together We Improve Homes & People's Lives](#)

material.

2. Install solid 4" ABS vent pipe from foundation drain tile or localized pocket of granular fill through roof. Do not install vent pipe within exterior walls of the house. Install plumbing penetration boot on roof to prevent water leakage at roof penetration.
3. All pipe connections and penetrations through the basement slab to be airtight.
4. Test lowest inhabitable area of house for radon at the beginning of occupancy using qualified test kit. Either a 48-hour test or a 90-day test is acceptable. Levels must be below 4 pico-curies.
5. If dangerous levels of radon are present (4 or more picocuries per liter), install continuously operating, in-line fan in vent pipe.
6. Retest
7. If dangerous levels of radon still exist, contact radon mitigation specialist.
8. Supply homeowner with a copy of the test results.

Exceptions:

- If installing a radon mitigation system will create serious hardship for the owner and/or the home has restrictions because of a historical district, the test may be performed in the lowest bedroom in the home.
- When more than 4 picocuries are detected, two additional tests can be performed in the lowest finished room. If radon levels are safe there, the installation of a mitigation system is optional.

Rationale:

- In order for a home to be considered Green the occupants' health cannot be knowingly placed at risk. Because we can test for and install systems that improve the indoor environmental quality of the home it is our responsibility to take this step.
- Any time the soil gas barrier system is disturbed, there is the potential that radon levels will increase beyond the safety threshold. Testing after the work is completed is currently the only way to determine if the level of radon in the air is safe.
- Considerations:
- Radon is a known carcinogen and a cancer-causing agent. Radon, a Nobel gas, will always occur, so full containment is impossible. However, removing radon and other soil gases from the home as a preventative measure to reduce a known cause of lung cancer has little cost when compared to the cost of human life.

Resources:

- Protecting Your Home From Radon: A Step-By-Step Manual for Radon Reduction, Second Edition.

[Thank You Sponsors - Together We Improve Homes & People's Lives](#)

Colorado Vintage Companies, Inc.
525 East Fountain Boulevard, Suite201
Colorado Springs, CO 80903
Phone: (719) 632-1215 Fax: (719) 632-9607
www.coloradovintage.com

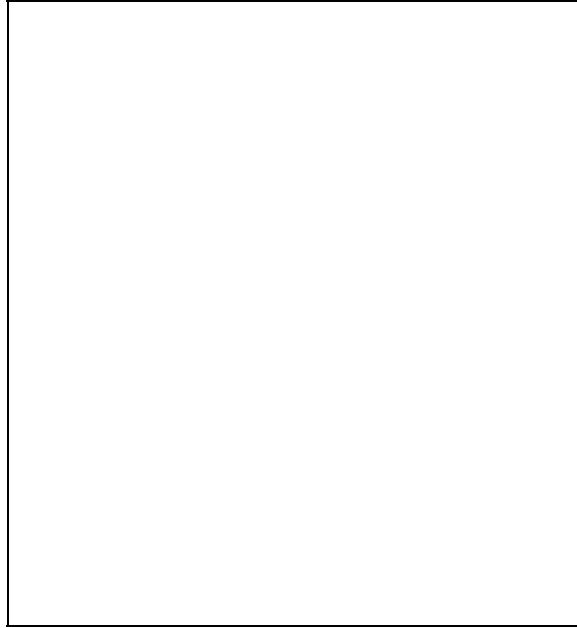

Major Radon Entry Routes:

- A. Cracks in concrete slabs
- B. Spaces behind brick veneer walls that rest on uncapped hollow-block foundations
- C. Pores and cracks in concrete blocks
- D. Floor-wall joints
- E. Exposed soil, as in a sump or crawl space
- F. Weeping (drain) tile, if drained to an open sump
- G. Mortar joints
- H. Loose fitting pipe penetrations
- I. Open tops of block walls
- J. Building materials, such as brick, concrete, and rock
- K. Well water (NOT commonly a major source in Minnesota homes)

[Thank You Sponsors - Together We Improve Homes & People's Lives](#)

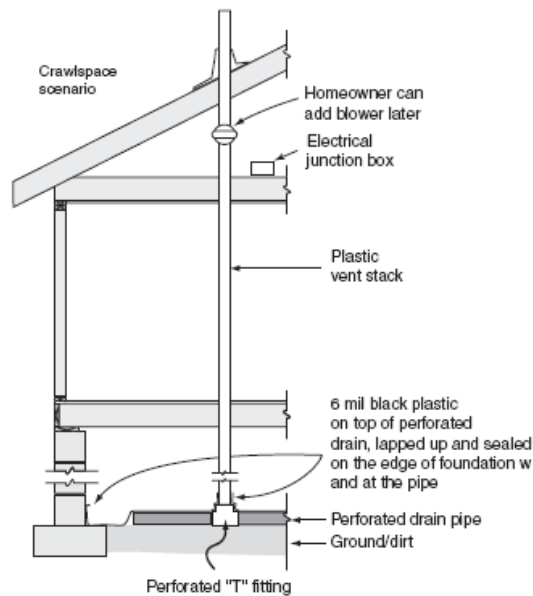

OPR-11_ Minimum of one approved and fully operational carbon monoxide alarm installed within ten (10) feet of each bedroom

Requirements:

- All carbon monoxide alarms must be certified by a nationally recognized testing laboratory that conform to the latest Underwriters Laboratories (U/L) Standards known as UL-2034.
- It is important to recognize the differences between smoke alarms and carbon monoxide (CO) alarms. CO alarms activate based on the concentration of CO over a period of time; this allows for a brief period to ensure that everyone is alright and for the occupant(s) to investigate possible sources of CO accumulation within the home. When a smoke alarm sounds, all occupants should immediately vacate the premise and call 911. Alternatively, if a CO alarm sounds in the residence a person should verify that the occupants are not showing signs of CO poisoning (headache, nausea, vomiting, disorientation, etc.). If anyone in the home has symptoms of CO poisoning, call 911 immediately. If no one has symptoms of CO poisoning, open windows or doors to allow fresh air to enter and contact the utility company or appliance repair company as soon as possible.
- There is a difference between smoke alarms and carbon monoxide alarms and they shall not be used interchangeably. The Minnesota State Fire Code (MSFC) has regulations on the location, placement and power supply of smoke alarms inside

[Thank You Sponsors - Together We Improve Homes & People's Lives](#)

residential dwelling units depending on the date of construction. Some manufacturers, however, have devices that are combination smoke alarm/carbon monoxide alarms. These devices are acceptable. In the case that these combination devices are installed, the smoke alarm installation requirements shall be followed.

- Carbon monoxide alarms have an effective lifespan of 5-7 years. Many manufacturers recommend these devices be replaced at six (6) year intervals.
- It is important that these devices be installed in accordance with the manufacturer's installation instructions and not be placed in 'dead' air pockets such as corners of rooms, at the junction of walls and ceilings, or within 36" of ventilation ducts.
- Carbon monoxide alarms shall be installed at the height specified in the manufacturer's installation instructions.
- Combination smoke alarm/carbon monoxide alarm units are acceptable.

Exceptions:

- None

Rationale:

- This carbon monoxide alarm requirement is currently required by code for NEW construction in Minnesota, and all EXISTING homes will be required to comply August 1, 2008. It is appropriate for this Green building program to require carbon monoxide alarms on remodels today.

Resources:

- CARBON MONOXIDE ALARMS - MINNESOTA STATUTE 299F.50

OPR-12_ No NEW atmospherically vented combustion appliances allowed. (use direct vented, power vented or sealed combustion). Existing atmospherically vented appliances can remain.

Requirements:

- Notes on plans and/or specifications indicating equipment to be installed.
- Install equipment following the manufacturers specifications.
- Photo of installed equipment -OR- rater check off.

Exceptions:

- Existing atmospherically vented appliances can remain.
- Power venting for gas cooking appliance can consist of kitchen exhaust hood and/or kitchen exhaust fan in kitchen ceiling.
- Decorative wood burning fireplaces and stoves must meet the requirements in Sub-section 5E Miscellaneous Mechanical.

Rationale:

[Thank You Sponsors - Together We Improve Homes & People's Lives](#)

- Atmospherically vented combustion appliances are much more susceptible to combustion spillage, especially in well built, air tight homes.
- Sealed combustion and/or power vented equipment is becoming readily available.

Considerations:

- Note: See section 5E Miscellaneous Mechanical for requirement related to decorative fireplaces and stoves.

Resources:

- TBD

OPR-13_ All projects must pass Fresh Air Supply (FAS) and Worst Case Combustion Spillage (WCCS) tests at end of the project. Include fireplaces in WCCS test. See exceptions below.

Requirements:

- **Document fresh air supply (FAS) system.**
Describe type of system (e.g., totally leakage based, leakage based with exhaust only fan, supply only fan, HRV, ERV, etc.).
- Submit calculations showing required FAS.
 - Indicate whether adequate fresh air levels are being met using the following two criteria:

1. Total required ventilation rate (CFM) = (0.02 x square feet of conditioned space) + [15 x (number of bedrooms +1)]

2. Continuous ventilation rate shall be a minimum of 50% of the total ventilation rate, but not less than 40 cfm. Note: If either of these two criteria is NOT met, ventilation must be improved. See Section 5 (Mechanical Systems) for strategies and points associated with this. (CFM-natural is considered continuous.)

A home that does not have an adequate amount of fresh air exchange naturally can be supplemented with a simple mechanical fresh air system. As one would expect, more elaborate systems are available; they typically have more features that increase comfort and energy efficiency, but also have an increased installation cost. This cost may be recovered over time due to their increased efficiency.

- Perform blower door test at the end of the project to determine ACH natural.
ACH natural = Air Changes Per Hour @50 Pa (CFM50x60/House Volume)

[Thank You Sponsors - Together We Improve Homes & People's Lives](#)

- If mechanical ventilation is required to meet FAS requirements, then:
 - Test actual air flow of equipment and submit results.
- **Submit WCCS report from Rater.**
 - GreenStar approved Rater must perform WCCS test at the end of the project according to one of the following protocols:
 - *Minnesota Building Performance Association (MBPA) Existing Home Checklist*
 - House Depressurization Limits (HDL) are listed on the MBPA Checklist. See also credit 1B - 2 of this manual.
 - TIP: Having the Rater
 - ASTM E1998-02 2007 *Standard Guide for Assessing Depressurization-Induced Backdrafting and Spillage from Vented Combustion Appliances*
 - Canadian Standard CGSB 51.71 2005
 - Other similar testing protocols may be acceptable. Rater should submit request for acceptance to GreenStar if they wish to use a different testing protocol.

Exceptions:

- If project scope of work WILL NOT affect FAS in any way or the venting of atmospherically vented appliances, homeowners can choose to skip this requirement.
- Replacing a pre-existing exhaust fan with one of equal cfm DOES NOT constitute a change to FAS or WCCS risk.
- Making changes to the flue pipe of an atmospherically vented appliances such as adding elbows or reducing upward angle DOES constitute a change and is therefore subject to the testing of this prerequisite.

Rationale:

- Everyone can agree that a clean Fresh Air Supply (FAS) is important in a home and that every home should be safe from too much combustion spillage from appliances.
- There is a (usually unrealistic) concern that the cost of performing the blower door test and WCCS test on some small projects, that are not even making any changes to these systems, would put an unreasonable financial burden upon them.
- Combustion Spillage:
Many people do not realize it, but SOME combustion spillage is common in almost all homes, unless there are no atmospherically venting appliances that exist at all. Even an atmospherically vented appliance that is properly vented will usually have some spillage when it initially fires and before the flue vent gets hot. Another common source of combustion spillage is from natural gas cooking appliances. Even if a proper range hood is installed, it usually will not capture all combustion gasses and most people do not turn it on every time they use the stove. Typically small amounts of combustion spillage are not thought to be noticeably harmful.

[Thank You Sponsors - Together We Improve Homes & People's Lives](#)

What people also do not realize is that even though they may not notice any problems, many existing homes do not meet FAS and WCCS standards.

This is where the issue gets a little more complicated. On existing homes, disagreement exists over how much fresh air is required, how much combustion spillage is acceptable, and when is it necessary to make changes to reduce or eliminate them.

Building code typically does not require any improvements to be made to a home on these two issues unless changes are being made to the home that would change the amount of air infiltration (leakage) of the home. The net result is that some sub-standard homes are allowed to go unchanged.

What we DO NOT fully know as an industry is to what degree people are being negatively affected by substandard fresh air supply and combustion spillage in their homes. This may change. Currently, some building science professionals believe that some people are being affected either intermittently or continually, and that the effects are not being directly traced back to fresh air supply and/or combustion spillage as they should.

What we DO know is that it is a best practice for ALL homes to pass FAS and WCCS tests at the end of the project, and that it is most prudent to perform these tests at the beginning of the project, at a minimum, to help inform the design and construction process.

For this reason it is highly recommended that ALL projects undergo FAS and WCCS testing

Considerations:

- It is most prudent to perform these tests at the beginning of the project, at a minimum, to help inform the design and construction process.

Resources:

- For a copy of the *Minnesota Building Performance Association (MBPA) Existing Home Checklist*, See TEMPLATES & RESOURCE FILES in the shared folder for the project.
- TECTITE Software, which is available from the Energy Conservatory.
(www.energyconservatory.com/products/products8.htm)

This software can be used to help predict if mechanical FAS will be needed at the end of the project based on pre-construction air leakage testing and expected improvements planned for the scope of work for the remodel project.

Optional Step-by-step guide to meeting the requirements of OPR-13.

[Thank You Sponsors - Together We Improve Homes & People's Lives](#)

Note: Although the main requirement of OPR-13 is that the house passes the FAS and WCCS at the end of the project, it is prudent to also perform these tests at the beginning of the project, to help inform the design and construction process. These step-by-step guidelines help navigate through that process depending on a variety of possible pre-existing conditions.

OPR-13a_ Atmospherically vented appliances WILL NOT exist at end of project (regardless of whether they exist at the beginning), AND Scope of work on project WILL NOT affect air leakage

- BD with FAS calculation at beginning
- If failed FAS at beginning then take action to correct
- If failed FAS calculation at beginning then submit passing FAS calculation or BD with FAS calculation at end depending on FAS system used

(see also flow chart below)

[Thank You Sponsors - Together We Improve Homes & People's Lives](#)

OPR-13a. Flow chart

[Thank You Sponsors - Together We Improve Homes & People's Lives](#)



Atmospherically vented appliances **WILL NOT** exist at end of project (regardless of whether they exist at the beginning), **AND** scope of work on project **WILL NOT** affect air leakage.

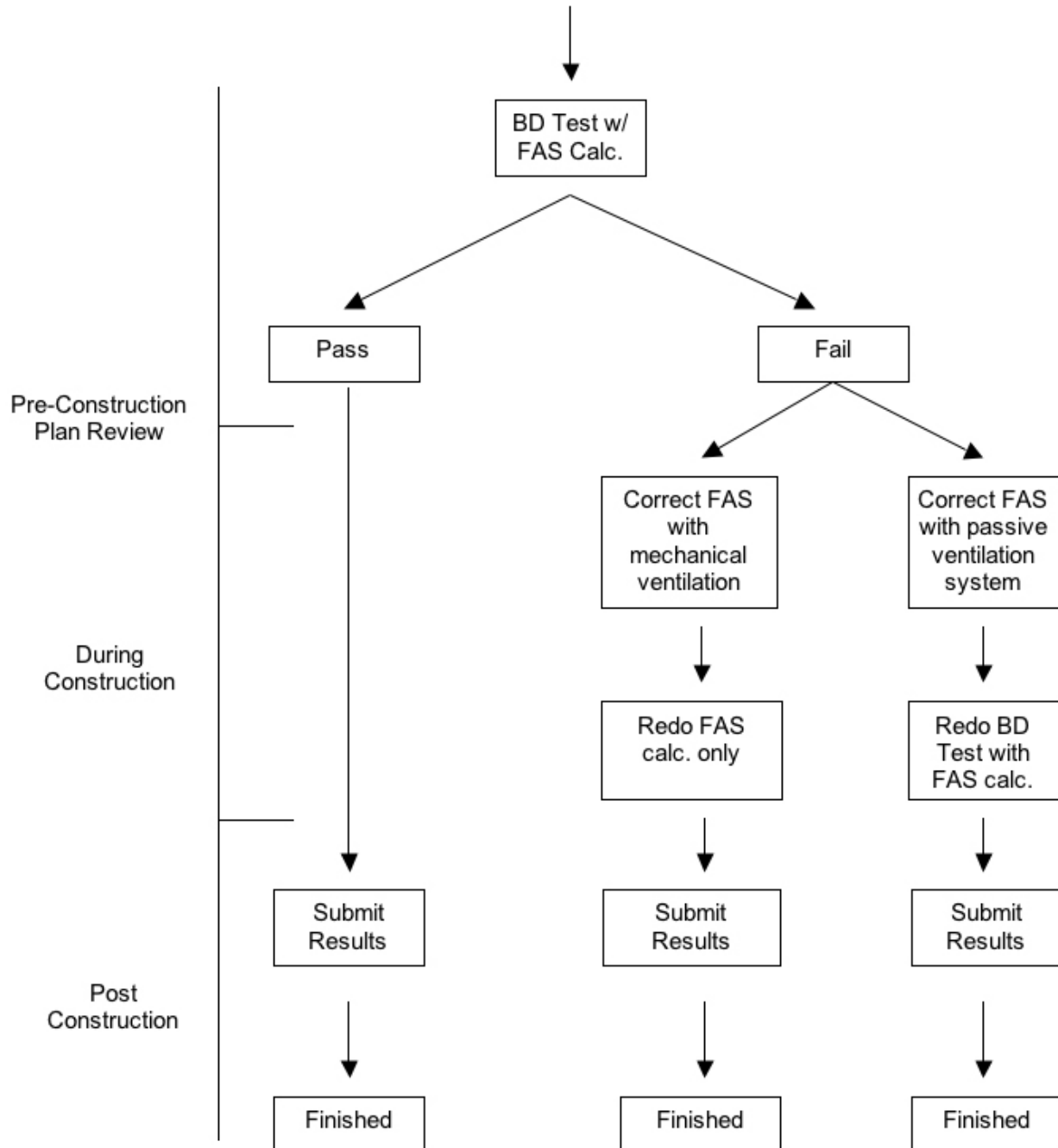

[Thank You Sponsors - Together We Improve Homes & People's Lives](#)

OPR-13b_ Atmospherically vented appliances WILL NOT exist at end of project (regardless of whether they exist at the beginning), AND scope of work on project WILL affect air leakage

- BD with FAS calculation at beginning
- Plan for FAS system if needed depending on FAS beginning calculation and expected reduction in air leakage
- BD with FAS calculation at end
- If still fail FAS then take additional action to correct (unlikely that this would happen)

(see also flow chart below - TBD)

OPR-13b. Flow chart - TBD

OPR-13c_ Atmospherically vented appliances DO exist at beginning of project and WILL exist at the end, AND scope of work on project WILL NOT affect air leakage

- BD with FAS calculation and WCCS at beginning
- If failed FAS at beginning then take action to correct
- If failed WCCS at beginning then take action to correct
- If failed FAS at beginning then redo FAS calculation or BD with FAS calculation at end depending on FAS system used - submit passing results
- If failed WCCS test at beginning then redo WCCS at end - submit passing results

(see also flow chart below - TBD)

OPR-13c. Flow chart - TBD

OPR-14_ Mandatory Green education of homeowner during construction by General Contractor (4 hour min.)

Requirements:

- 4-hour minimum spent educating homeowner
- Contractor must provide a users manual to the homeowner containing a) home maintenance instructions and recommendations, b) home maintenance schedules, and c) users manuals and any warranty information for all equipment installed by the contractor.
- See also Section 10 - Education, of this checklist.

[Thank You Sponsors - Together We Improve Homes & People's Lives](#)

Rationale:

- It is widely understood that a homeowner needs to understand how to maintain and operate their home in order to ensure it continues to operate safely and at optimal levels.
- It is also understood that homeowners who understand what best practices exist and are available, will be more likely to choose them in the future.

Considerations:

- None

Resources:

- TBD

OPR-15_ Mandatory Green remodeling education of homeowner at end of project (2-hour minimum)

Requirements:

- Conduct an end-of-project walk-through meeting to explain to the homeowner how the products and systems of the house work, review why they were installed, and how they are maintained.
- Vapor barrier primers must be documented for homeowner if they were used.

Exceptions:

- None

Rationale:

- There are many distractions and emotions that occur during design and construction that may prevent a homeowner from understanding critical care issues related to the products and equipment that are featured in the remodel. A walk-through of the home after the dust has cleared and the occupants have returned to the space is critical for helping them to understand what was actually installed and how it should be maintained.

Considerations:

- None

Resources:

- TBD

[Thank You Sponsors - Together We Improve Homes & People's Lives](#)

OPR-16_ Provide homeowner with a user's manual covering house maintenance and green features of home.

Requirements:

- Assemble and give to homeowner a manual containing the pertinent information on their Green remodel, including:
 - Product manuals for all installed equipment, fixtures, products, and appliances, plus an outline of what needs to be maintained and how and when to do it
 - Green features of the home including certifications
 - Resources for help with repairs or maintenance
 - Resources for finding replacement parts such as filters or hoses

Exceptions:

- None

Rationale:

- It is easier for homeowners to accept their role in making their home function as intended when they are given clear explanations and illustrations of the necessary care of the home, especially if they are presented in an easy-to-access format. A manual takes the guesswork out of owning a home.

Considerations:

- None

Resources:

- None

OPR-17_ Obtain all required permits & follow all required local and state building codes

Requirements:

- If any strategy of the GreenStar program is in conflict with a local or state building code. The local building code is to be followed and GreenStar must be notified ASAP.

Exceptions:

- None

Rationale:

- MI GreenStar has taken great care to ensure that all of the strategies contained herein are NOT in conflict with any local or state building codes, and MI GreenStar actively reviews new codes for possible conflicts when new codes are issued. However

[Thank You Sponsors - Together We Improve Homes & People's Lives](#)

it is impossible for MI GreenStar to be aware of every unique code that may exist, and the final responsibility to know the codes that apply in the location of any given project belongs to the builder who is doing the actual construction work.

Considerations:

- None

Resources:

- National Efficiency Standards and Specifications for Residential and Commercial Water-Using Fixtures and Appliances:
<http://www.epa.gov/watersense/docs/matrix508.pdf>

OPR-18_ Prepare and post a job-site materials management and recycling plan. By posting a plan, the details of the plan are communicated, shared and reinforced with everyone on-site.

Requirements:

- Identify all possible materials for reuse and recycling before construction starts.
- Create an easy-to-read plan and post at job-site
- Photograph plan at job-site.

Exceptions:

- None

Rationale:

- Contact the specific organizations, private businesses or individuals who accept, facilitate dispersal of or buy said materials and research details of how to work with them.
- Start communicating the plan to sub contractors on the initial sub walk through
- Another option to disperse materials that are in demand by the public is to designate an area on-site that is highly visible to the public where reusable or recyclable items can be set out for free
- Identify items for recycling, considering possible available management options:
 - Hiring a job-site clean-up service
 - Sending to a commingled recovery facility
 - Separating onsite and hiring haulers
 - Separating onsite and self-hauling

Considerations:

- None

Resources:

[Thank You Sponsors - Together We Improve Homes & People's Lives](#)

- TBD

OPR-19_ No burying or burning of construction waste

Requirements:

- All construction debris must be directed to a waste management facility.
- General contractor to sign-off on checklist.

Exceptions:

- Any solid, untreated wood (other than kiln dried), or clean, unpainted drywall scrap can be either chipped for mulch, or in the case of drywall, be ground and used as a soil amendment.

Rationale:

- Burning construction waste is illegal in many areas and is poor practice because most garbage burners have technologies to eliminate some of the pollutants. Burying construction waste is poor practice because landfills have liners and other strategies to reduce contamination into the soil and eventually the water table.

Considerations:

- None

Resources:

- TBD

OPR-20_ Seal all ducts and air handlers to prevent contamination during construction

Requirements:

- Rater verification

Exceptions:

- If the ducts are required to heat, cool, or return air to the air handling equipment during construction, only seal the ducts in the area of work, and well seal the construction area.

Rationale:

- This is a best practice solution for preventing contaminants from entering ventilation ducts and minimizing contaminants in the ductwork.
- It is always important to clean ducts after construction, change filters immediately after construction, and change them again a maximum of two weeks after.

[Thank You Sponsors - Together We Improve Homes & People's Lives](#)

Considerations:

- It is nearly impossible to prevent contaminants and dust to enter the ductwork. Always take care to check sealing regularly as construction can damage tape or other materials used to seal ducts.

Resources:

- None

OPR-21_ No construction debris discarded and closed inside any wall assembly

Requirements:

- All construction debris must be disposed of properly, be it recycled or sent to the waste management facility. No food remnants, scraps, or other construction debris can be placed or left in the wall cavity.
- General contractor to sign-off on checklist.

Exceptions:

- None

Rationale:

- Discarding construction debris in the wall assembly is a disregard for the integrity of the construction and should never be a part of the construction practice.
- Leaving debris in the wall assembly is a potential fire hazard.

Considerations:

- None

Resources:

- TBD

[Thank You Sponsors - Together We Improve Homes & People's Lives](#)

1_Pre-construction_Design_Strategies

The most significant and cost effective impact builders and homeowners can have on a new construction project occurs before work has begun; this is called Pre-Construction Design Strategies. It is at this time when wishes, wants and desires, uses of the home and its occupants, and a whole home evaluation can take place. All too often, comprehensive design work done before construction begins is looked upon by builders and homeowners as an unnecessary expense—one which requires additional time and financial resources that are perceived to eat into the construction budget. However, careful planning in advance of construction can often eliminate expensive oversights during construction. As a rule of thumb, it is less expensive to spend the time and money in pre-construction design than it is to correct foreseeable issues during the construction process.

This chapter, Pre-construction Design Strategies, is for any size home. No matter how large or how small the home may be, it can benefit from pre-construction planning by developing strategies, which can affect the performance of the whole home and landscape. This reinforces the notion that the house is a system with interrelated and interconnected parts. Before beginning the project, think through what the eventual goals of the home and homeowner's lifestyles may be. Can turf be significantly reduced and lawn maintenance equipment eliminated if the lawn is replaced with a wildflower garden and no-mow turf? If the home is built near public transportation, can the homeowner save money on their monthly transportation bills by using public transportation while offsetting the increasing cost of energy?

In this section, you will have the opportunity to explore options for Universal Design and sustainable lifestyle. The process of modeling the energy usage of your home and evaluating carbon emissions will be rewarded in this section.

Natural light, passive solar, and stack/cross ventilation strategies may reduce or eliminate need for electrical and mechanical heating and cooling devices and reduce the amount of electric light required during daytime hours.

Daylight also contributes to the general health of the home as the sun is a natural sanitizer, and provides health benefits to occupants. Proper location of new windows, skylights (and solar light tubes), and doors, when combined with roof overhangs, outdoor vegetation, and/or awnings can provide daylight and heat in the winter, and shade and cooler temperatures in the summer.

Similarly, stack and cross ventilation through windows, skylights, and doors can cool a home without the need for mechanical cooling. Proper operation and placement of windows and doors is critical to the effectiveness of stack and cross ventilation but can have dramatic results. At present, there are a wide variety of different window and skylight types on the market, and each one can employ a different strategy. Energy-10 software (www.energy-10.com) is a useful tool to help with this section.

[Thank You Sponsors - Together We Improve Homes & People's Lives](#)

Prerequisites:

- None

1A - Integrated Project Team

1A-1_ Create multi-disciplinary project team, including homeowner, contractor and all subcontractors and include each in design and pre-construction meetings

Requirements:

- All project team members must sign-off
- Pre-construction and post-construction meeting, including homeowner, to review performance and any known issues

Exceptions:

- None

Rationale:

- Having a comprehensive team meeting of all key contractors is crucial to the performance of the home. Having the homeowner involved in these key kick-off and closeout meetings is important so they understand what will happen to the home, and how to use equipment.

Considerations:

- None

Resources:

- TBD

1A-2_ Post-construction meeting for contractor, homeowner, and key subcontractors to review performance and lessons learned

Requirements:

- The contractor or project manager will conduct meeting/s between self and homeowner, self and subcontractors, or all parties together to gather feedback about the building process and strategies used.
- All project team members must sign-off on checklist.

Exceptions:

- None
-

[Thank You Sponsors - Together We Improve Homes & People's Lives](#)

Rationale:

- By gathering feedback about the project and strategies at the completion of a home, lessons learned can be applied to future projects.

Considerations:

- None

Resources:

- TBD

1A-3_ Trained Project Team. Project team member(s) have MI GreenStar Professional Designation status of "Qualified" or higher.

Select one:

- | | |
|-------|---|
| 1A-3a | 1 member = 1 point in all 5 categories |
| 1A-3b | 2 members = 2 points in all 5 categories |
| 1A-3c | 3 members = 3 points in all 5 categories |
| 1A-3d | 4 to 10 member = 4 point in all 5 categories |
| 1A-3e | 11 or more members = 5 points in all 5 categories |

Requirements:

- Supply reference number from training.
- Must enter the contact information for team member and the company they represent on the "Project Team" input page of the checklist.
- 1 member from every unique company working on the project can be counted.
- Homeowner can also be counted if they attended training.
- Must be in good standing through the time period the project is taking place.

Exceptions:

- None

Rationale:

- A successful Green home begins with an understanding of Green building and the implementation of strategies, products, and systems into the design.
- Having more people on the project team trained, increases the quality of the project and the smoothness of the process.

Considerations:

- None

[Thank You Sponsors - Together We Improve Homes & People's Lives](#)

Resources:

- TBD

1B -DESIGN

1B-1_ Document all existing conditions, equipment, and assemblies in house

Requirements:

- Use form from the checklist and provide required documentation.
- Form TBD

Exceptions:

- None

Rationale:

- Every home can benefit from having all existing conditions reviewed. Think of it as a sort of packing list: what was included, what was missing yet needed, and what could be better.

Considerations:

- This is beneficial to all involved in the project. It sets a baseline of conditions from which to plan and design from.

Resources:

- Form 1B-1 (form TBD)

1B-2_ Contract with a GreenStar approved rater for a pre-design, whole home inspection (RECOMMENDED)

Requirements:

- GreenStar approved Rater must produce report using the *Minnesota Building Performance Association (MBPA) Existing Home Checklist*, which is included below.
- Data on report should include but not be limited to the following:
 - Blower door test before and after project
 - Infrared scan before and after project
 - Worst Case Combustion Spillage Test
 - Duct blaster test
 - Carbon footprint analysis
 - Visual inspection for water leaks of both plumbing and site/building envelope

[Thank You Sponsors - Together We Improve Homes & People's Lives](#)

- Environmental hazards including lead, radon, mold and carbon monoxide
- Structural failures or deficiencies

Exceptions:

- None

Rationale:

- Whole home performance rating is very beneficial to the overall efficiency of a home. In some cases, an energy rater can alert the homeowner or contractor to potential or known hazards that may otherwise go unnoticed.
- See Air Infiltration credits for additional points once the Rater has results and expected air tightness ratings based on improvements that are planned for the project.

Considerations:

- The GreenStar Rater may need to consult with additional building professionals if the home seems to have a complex series of issues or problems.

Resources:

- www.MNGreenGtar.org
- Minnesota Building Performance Association (MBPA) Existing Home Checklist

[Thank You Sponsors - Together We Improve Homes & People's Lives](#)

Home Performance FIELD DATA COLLECTION FORM

Customer Information					Test Date:				
Name									
Address									
City		State			Zip				
Phone: ()		Email:							
Electric Provider			Account Number						
Heating Fuel Provider			Account Number						
Customer Top Concerns:									
1.									
2.									
3.									

Zero CO detector (Follow manufactures instructions)

Record outdoor temperature. _____ F.

General Building Data					Weather Condition:				
Building Age		# of Occupants			Building Type (check one)		<input type="checkbox"/> Single Family		
# of Stories		Ceiling Height					<input type="checkbox"/> Duplex		
Sq. Ft. Conditioned Floor Area		House Volume					<input type="checkbox"/> Split Level		
Rental Unit:	<input type="checkbox"/> Yes	<input type="checkbox"/> No					<input type="checkbox"/> Mobile Home		
Landlord Name:									
Landlord Address:									

Foundation Type:	
Siding Type:	

Air tightness: A multiple point test (and correlation coefficient) is recommended if using a magnehelic or DG300 pressure gauge.

Pressure Gauge: DG -700 DG-3 Magnehelic

Conditioned floor area: _____ ft² Building volume: _____ ft³

Total ext. surface area (from ratings calc.) = _____ ft²

Recommended CFM@50 limit = .25 × ext. surface area: _____ cfm50

Baseline pressures (not required with DG 700): Start _____ Pa End _____ Pa

Temperature °F: _____ in / _____ out **Tested cfm@50:** _____ **Ring:** _____

Correlation coefficient > = .99 (not required with DG 700): _____

House	Fan	Ring

1/23/2009

Blower Door Test Results & Air Leakage Sites			
Pre Blower Door Test		CFM50	Post Blower Door Test
Air Changes Per Hour @50 Pa (CFM50*60/Volume)		Pre	Post
Air Leakage Sites (check all that apply):			
<input type="checkbox"/> Chimneys	<input type="checkbox"/> Soil Stacks	<input type="checkbox"/> Electrical Penetrations	
<input type="checkbox"/> Plumbing Penetrations	<input type="checkbox"/> Pocket Doors	<input type="checkbox"/> Tongue & Groove Ceiling	
<input type="checkbox"/> Mechanical Chase	<input type="checkbox"/> Void Around Stairwell	<input type="checkbox"/> Band Joist	
<input type="checkbox"/> Windows	<input type="checkbox"/> Sill Plate	<input type="checkbox"/> Drop Soffit	
<input type="checkbox"/> Porch Ceiling	<input type="checkbox"/> Recessed lights _____ #	<input type="checkbox"/> Open Partition Wall at Top Plate	
Other: _____			
Other: _____			

Insulation Values							
Insulation Area	Sq Ft to Insulate	Pre R-Value	Post R-Value	Insulation Area	Sq Ft to Insulate	Pre R-Value	Post R-Value
Open Joist Attic				Sidewalls			
Closed Floor Attic				Int. Foundation			
Sloped Ceiling				Ext. Foundation			
Gable End Walls				Floor			
Knee Wall Attic				Mobile Home Floor			
Cathedral				Mobile Home Wall			
Sill Box				Mobile Home Ceiling			
Other				Other			

Heating Equipment Information (Existing Unit)			
Heating Fuel Type: <input type="checkbox"/> Natural Gas <input type="checkbox"/> Propane (LP) <input type="checkbox"/> Oil <input type="checkbox"/> Electric <input type="checkbox"/> Other:			
Existing Heating System Type (check one): <input type="checkbox"/> Forced Air <input type="checkbox"/> Boiler (steam) <input type="checkbox"/> Boiler (water)			
<input type="checkbox"/> Heat Pump <input type="checkbox"/> Wall Furnace <input type="checkbox"/> Room Space Heater <input type="checkbox"/> Electric Baseboard <input type="checkbox"/> Other:			
Existing Heating System (check One): <input type="checkbox"/> Atmospheric <input type="checkbox"/> Condensing <input type="checkbox"/> Induced Draft			
Existing Unit Age:	Existing AFUE: %	Recommend Replacement?	Fuel Switch Opportunity?
		<input type="checkbox"/> Yes <input type="checkbox"/> No	<input type="checkbox"/> Yes <input type="checkbox"/> No

Water Heating Equipment Information (Existing Unit)			
Water Heater Fuel Type <input type="checkbox"/> Natural Gas <input type="checkbox"/> Propane (LP) <input type="checkbox"/> Oil <input type="checkbox"/> Electric <input type="checkbox"/> Other:			
Water Heater Type (check one): <input type="checkbox"/> Atmospheric <input type="checkbox"/> Power Vented <input type="checkbox"/> Electric <input type="checkbox"/> Other:			
Existing Unit Age:	Existing Gallons	Recommend Replacement	Fuel Switch Opportunity?
		<input type="checkbox"/> Yes <input type="checkbox"/> No	<input type="checkbox"/> Yes <input type="checkbox"/> No

Notes:

1/23/2009



Combustion Safety Testing

Test Setup Procedures

- ✓ Turn combustion appliance to pilot (Preventing operation during set-up)
- ✓ Record house ambient CO level. _____ ppm
- ✓ Put house in winter condition. (Including latching or locking windows)
- ✓ Install hose; CAZ WRT (with respect to) Outside.
- ✓ Check furnace filter, replace if dirty when possible.
- ✓ Close all operable vents (Example -- Fireplace damper).
- ✓ Clean lint filter in dryer.

Combustion Appliance Zone Pressure / (CAZ) Pressures (Pa.)

Unable to perform test due to: _____

	Pre test	Post test
1. Baseline test: (Interior doors open, exhaust appliances off)		
2. Turn on all exhaust appliances in Home		
3. Turn on furnace air handler		
4. Close interior doors, measure the pressure difference between main body and the room you are closing off. (If negative leave door open, if positive keep door closed.)		
5. Close basement door (or door to CAZ) and determine position based on CAZ WRT outside (If the reading becomes more negative – leave door closed. If reading becomes more positive, open door).		
6. Check CAZ wrt outside, determine if furnace fan contributes to depressurization.		
7. Record worst case depressurization.		

- ✓ Make observation of any supply or return grills in the CAZ
- ✓ Inspect integrity and design of venting system
- ✓ Check for blocked supply or return registers
- ✓ Remember to check for backdrafting at diverter of water heater when running furnace in combined test.
- ✓ Recommend a CO detector in all homes when atmospherically vented appliances, gas ranges, or attached garages are present

Back draft and CO Test of atmospherically vented appliances

A combined test cycling heating system and water heater must be performed if both are tied together before the masonry chimney. Induced draft furnaces do not have to be tested for draft or CO but must be fired for the combined test.

Cycle combustion appliances for 3min. then record, Draft, CO and if any Spillage occurs.

Appliance	Draft Test				Carbon Monoxide				Spillage Y/N				
	Stand Alone Test		Combined Test		Stand Alone Test		Combined Test		Stand Alone Test		Combined Test		
	Pre	Post	Pre	Post	Pre	Post	Pre	Post	Pre	Post	Pre	Post	
Water Heater													
Heating System													
Other													
Notes:													

1/23/2009



Whole House Ventilation System: Check system for compliance with ASRAE 62.2 2007.

of bedrooms _____ Required Flow: _____ cfm = (# of bedrooms +1) x 7.5 cfm + 1cfm/100 sq. ft living area

Type: Exhaust fan _____
 ERV/HRV (fully ducted / single / double punch) interlocked
 Central exhaust

Tested flow: _____ Required flow: _____ Rated flow: _____

Spot ventilation: 20 CFM min. cont. capacity recommended for any room with either toilet, tub, shower, or cook top.

Location	Tested flow	Ventilation equipment type	Rated flow	Notes
		Type: <input type="checkbox"/> Exhaust fan <input type="checkbox"/> ERV/HRV <input type="checkbox"/> Central		
		Type: <input type="checkbox"/> Exhaust fan <input type="checkbox"/> ERV/HRV <input type="checkbox"/> Central		
		Type: <input type="checkbox"/> Exhaust fan <input type="checkbox"/> ERV/HRV <input type="checkbox"/> Central		
		Type: <input type="checkbox"/> Exhaust fan <input type="checkbox"/> ERV/HRV <input type="checkbox"/> Central		
		Type: <input type="checkbox"/> Exhaust fan <input type="checkbox"/> ERV/HRV <input type="checkbox"/> Central		
		Type: <input type="checkbox"/> Exhaust fan <input type="checkbox"/> ERV/HRV <input type="checkbox"/> Central		

Exterior Duct Leakage: Testing recommended if any portion of the duct work (or air handler) is outside the thermal / pressure boundary. ENERGY STAR requires duct leakage must be ≤ 6 cfm@25 pascals per 100 sq. ft. of conditioned floor area served by system.

Conditioned floor area: _____ /100 x 6 = _____ max duct leakage limit

House pressure (w.r.t outside): _____ Duct pressure (w.r.t house): _____ Flow plate: _____

CFM flow (to zero duct pressure): _____

Pressure Drop Across A Coil			
Pressure Drop: w.c. or PA		Pressure Drop: w.c. or PA	
Temperature:		Temperature:	

Notes:

1/23/2009



Combustion Safety Test Action Levels

Carbon Monoxide level is tested before the diverter

CO test results	And/Or	Draft Test Results	Action
>0	And	Fails	Work may not proceed. Arrangements must be made to correct drafting problems. Disclosure form must be signed
0 - 25ppm	And	Passes	System is OK
26 – 99 ppm	And	Passes	Recommend a clean and tune
>100 ppm	Or	Fails	Arrangements must be made to correct high CO levels and/or venting problem before work can proceed. Disclosure form must be signed
>200ppm	And	Passes	Work may not proceed until the system is serviced and the problem is corrected. Shut off equipment Disclosure form must be signed

Minimum Acceptable Draft Readings

Acceptable Draft Test Readings -- Outdoor Temperature						
F	<20	21-40	41-60	61-80	>80	F
pa	-5	-4	-3	-2	-1	Pa
w.c.i.	-.02	-.016	-.012	-.008	-.004	w.c.i.

w.c.i. = inches of
water column
pa = pascals

House Depressurization Limits (HDL)			
Appliance	Chimney Height (ft)	Unlined Chimneys on Exterior Wall	Metal Lined, Insulated or Interior Chimneys
Gas Fired Furnace	13 or less	5 pa	5 pa
Boiler, DHW Heater	14 – 20	5 pa	6 pa
	21 +	5 pa	7 pa
Oil Fired Furnace	13 or less	4 pa	4 pa
Boiler, DHW Heater	14 – 20	4 pa	5 pa
	21 +	4 pa	6 pa
Fireplace	N/A	3 pa	4 pa

(From: CMCH Chimney Safety Users' Manual (Reference #4 in Appendix A)
Note: Under summertime conditions, actual HDL's may be lower than shown above.

1B-3_ Energy modeling instructs home design and performance

Requirements:

- Provide Before and After energy modeling data. (i.e. “PERFORMANCE SUMMARY” report from REM/Rate or REM/Design energy modeling software)
- Raters are usually well equipped to provide energy modeling services, and are often the most cost effective way to obtain these services. However for the purposes of this credit, anyone can obtain one of the many energy modeling software packages and perform these calculations.

Exceptions:

- None

Rationale:

- Energy modeling software can instruct where energy improvements can be made. It may be upgrading mechanical equipment, or air sealing and insulating the home. Projected performance outcomes can also be modeled to understand how simple improvements can have a large impact.

Considerations:

- Computer software is never 100% accurate with ACTUAL energy usage and cost since it is impossible to fully predict the idiosyncrasies of the home’s occupants. Also utility rates fluctuate.

Resources:

- Residential Energy Services Network (RESNET), REM/Rate, REM/Design and Energy-10 computer software programs.
- Other energy modeling software programs exist, but not all of them are designed to give a HERS Index Score. See RESNET for more information.

1B-4_ Estimate carbon emissions of operating the home

Requirements:

- Provide estimated carbon emissions from modeling software

Exceptions:

- None

Rationale:

[Thank You Sponsors - Together We Improve Homes & People’s Lives](#)

- When we are made aware of how our homes and lifestyle choices may impact the community around us in the present and the future, we may make different design and material decisions prior to construction.

Considerations:

- None

Resources:

- Energy Raters often have software to calculate this.
Examples: REM / Rate and REM / Design.

1B-5_ Universal Design

Requirements:

- Drawings, including floor plans must account for handicapped accessible living, or show that the home can accommodate such needs in the future.
- The home must be truly adaptable to meet the requirements for Universal Design (i.e., a second floor bath remodel on a three story home would not qualify unless an elevator or other functioning method of transporting the individual to the space exists).

Exceptions:

- None

Rationale:

- Universal Design implies a home, which can accommodate less mobile occupants, occupants with disabilities, or homes that accommodate Aging in Place.

Considerations:

- Utilizing a Certified Aging in Place Specialist (CAPS) can help in developing the best layout.
- Universal Design may require that more space.

Resources:

- www.ada.org, www.narimn.org, www.batc.org

1B-6_ Allocate space in the home as a disaster protection area

Requirements:

- Floor plan must demarcate such area and list amenities and strategies to protect occupants for a minimum of three (3) days.

[Thank You Sponsors - Together We Improve Homes & People's Lives](#)

Exceptions:

- None

Rationale:

- Natural disasters can strike at any time. Different areas of the country, and different regions within a state have different natural disaster threats; tornadoes, hurricanes, floods, power outages, and wildfires will each require different resources. Design a space where the rest of the home can be sealed off and occupants can survive without heat or electricity for three (3) days. Include in this area storage for rations like water, non-perishable food, and other resources.

Considerations:

- No space is entirely safe. Make sure that the area is suited for a particular disaster known to the area.

Resources:

- Environmental Building News, May 2006

1B-7_ Passive solar heating design package (includes orientation, south glazing/floor area ratio orientation specific low-e tuning, summer shading and thermal mass design)

Requirements:

- Implementation of a passive solar heating design package integrates several individual strategies into one comprehensive strategy that produces results greater than the sum of its parts.
- Provide design package and demonstrate impact through calculations
- Show the location and angle of the sun during winter and summer months and how it will impact the structure (this is usually best described in a wall section or elevation).
- Provide non-roof overhangs, awnings, or louvers to exterior of west and south side of home.
- Install exterior solar shades on clear-glazed windows
- Install adjustable interior solar shades, films, or reflective blinds on existing east/west
- Install low-e film on interior side of clear-glazed windows and skylights

[Thank You Sponsors - Together We Improve Homes & People's Lives](#)

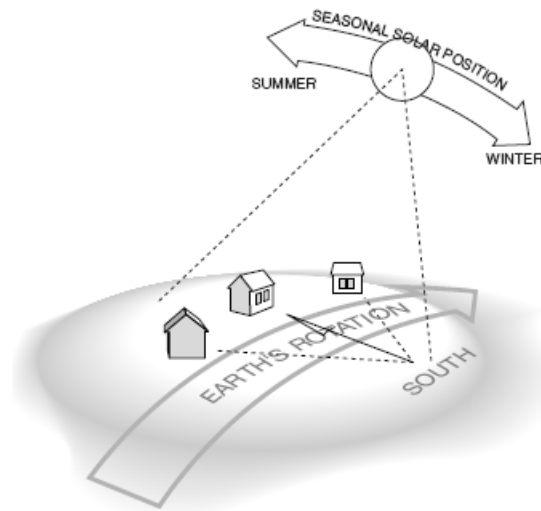

Seasonal location of the sun in the sky can determine window location, overhangs and landscaping considerations in passive solar homes.

*SBIC - Energy 10
www.sbicouncil.org*

Exceptions:

- None

Rationale:

- Designing our homes to work with the sun is one of the easiest Green building strategies for new home builders and only slightly more difficult for remodeling projects. Glazing, thermal mass, and shading techniques should be considered together rather than as separate building elements.

Considerations:

- Passive solar design does not mean just adding more windows to a home. Too much glazing in the wrong location can create larger problems with overheating in the summer, and heat loss in the winter.
- True passive solar homes require maintenance and monitoring. They also can require some fine tuning and plans should be made to educate the homeowner and to service the project.
- Sun angles are lowest and span the shortest time in the middle of winter, where the sun can penetrate farther into the home. Generally, in Minneapolis, winter sun angles are around 30 degrees off the ground (at its lowest on December 22nd). The opposite is true in the summer when the sun angles are highest and span the longest time—around 60 degrees in Minneapolis (June 21st). Planting trees and building outdoor

[Thank You Sponsors - Together We Improve Homes & People's Lives](#)

structures (such as pergolas and screened structures) and locating windows and doors to reflect the sun are key strategies in using the sun for its advantages—a free resource.

Resources:

- www.energy-10.com

1B-8_ Passive cooling design package (including orientation, summer shading, thermal mass, attic ventilation, additional ceiling fans, heat recovery ventilation, and natural ventilation design)

Requirements:

- Existing house does not have A/C system and remodel designed to provide passive cooling
- Implementation of passive cooling design package integrates several individual strategies into one comprehensive strategy that produces results greater than the sum of its parts
- Provide design package and demonstrate implementation
- No installation of any AC systems

Exceptions:

- None

Rationale:

- Just as with passive solar homes, a home that is designed to be a passively cooled home requires careful planning and calculations. Glazing can help to facilitate good cross ventilation and create interior breeze, but glazing in the wrong location can cause the home to overheat and negate the benefits of the potential ventilation.
- Considerations:
- True passive cooling requires homeowner education for operation and proper use.

Resources:

- www.energy-10.com

1B-9_ Building and landscaping plan, which reduces heating/cooling loads naturally

Requirements:

- Provide plan that shows materials and strategies
 - Provide explanation of the system and how it will meet the needs of the home
 - Blocking the solar access of a neighbor's house is not allowed
-

[Thank You Sponsors - Together We Improve Homes & People's Lives](#)

Exceptions:

- None

Rationale:

- Effective use of natural heating and cooling methods and strategies reduces energy loads with minimal environmental damage or with positive environmental impacts.

Considerations:

- Coniferous trees (like pine trees, which do not lose their needles) and deciduous trees (trees with leaves that drop in the fall) can have a great affect on how sunlight enters the home—plant locations and types of trees can either block or allow sunlight to enter the home. Designing awnings or other door and window overhangs must reflect the actual sun’s angles.
- Consider the long-term impacts of your plantings as well as the short-term. Planting rapid growth deciduous trees in sequence with slower growth deciduous trees will allow you to impact the home sooner, while still providing a good long-term solution for shading the home.
- Take care to consider the solar access of a neighbor’s house.

Resources:

- TBD

1B-10_ Home shares a common driveway with at least one other home

Requirements:

- Site plan must locate the shared driveway and adjacent home
- An alley is not a shared driveway
- Two garages located off an alley that share a driveway can qualify provided the drive is truly shared, meaning for either car to enter or exit it must utilize a significant portion of the neighbors drive.

Exceptions:

- None

Rationale:

- Sharing a common driveway saves space and construction materials, while leaving room for possible green open space or a more effective use of the space.

Considerations:

- None

[Thank You Sponsors - Together We Improve Homes & People’s Lives](#)

Resources:

- TBD

1B-11_ Existing attached garage converted to living space and NO NEW ATTACHED garage is constructed. New DETACHED garage is allowed.

Requirements:

- Verify that the construction quality of the existing attached garage is worthy of becoming conditioned living space.

Exceptions:

- None

Rationale:

- A detached garage minimizes hazardous emissions from vehicles and lawn equipment, cleaning solvents and contaminants on the garage floor from entering the home.

Considerations:

- None

Resources:

- TBD
-

1B-12_ House does not have A/C system and remodel designed to provide passive cooling

Requirements:

- Must provide documentation to communicate passive cooling strategy.

Exceptions:

- None

Rationale:

- Passive cooling is much more energy efficient than having an A/C unit.
- Designing a home remodel to not have an active cooling system except potentially a whole house fan, and passive cooling with overhangs and plantings outside is ideal.
- Some passive cooling design strategies include shading devices or trees, good air sealing and insulation, opportunity for stack-effect air circulation, whole-house fan for night flush of air, window placement to encourage cross-ventilation, etc.

Considerations:

[Thank You Sponsors - Together We Improve Homes & People's Lives](#)

- Depending on the climate, or the indoor climate desired, A/C systems can help remove humidity from the air and help the health of some occupants, and reduce the amount of moisture in a home.

Resources:

- See books written on the subject

1C - HOME SIZE

1C-1_ No increase to building footprint

Requirements:

- Building plans must demonstrate no addition to the building footprint.
- Footprint is the square foot area of the site taken up by the house foundation along with any parts of the structure that DO NOT have a minimum of 7' of head clearance (e.g., decks or porches on pier footings)

Exceptions:

- Adding up is not considered part of the building footprint
- Finishing a basement is not considered part of the building footprint
- Cantilevers (extensions without adding to the foundation or adding footings) are not considered adding to the building footprint

Rationale:

- Reorganizing existing space and adding “up” rather than “out” reduces the impact additional storm water runoff, building materials and reduced planted areas make on the environment.

Considerations:

- None

Resources:

- TBD

1C-2_ Total conditioned space of whole house after project completion is xx sq. ft. (measured to outside of insulated envelope)

Select one:

- | | |
|-------|-----------|
| 1C-2a | <1500 |
| 1C-2b | 1749-1500 |

[Thank You Sponsors - Together We Improve Homes & People's Lives](#)

1C-2c	1999-1750
1C-2d	2249-2000
1C-2e	2500-2250

The building envelope defines the conditioned and unconditioned spaces in the house. For the purposes of this program, the following rules should be used to determine conditioned space.

Requirements:

- Measure to the outside of the insulated envelope.
- In finished attics, measure the area that has a vertical dimension of 5' or more.
- Finished basements should be measured to the outside of the exterior walls.
- Basements that are insulated and air sealed, but otherwise unfinished (i.e., no drywall or floor finish) should be measured to the outside of the exterior walls.
- An unfinished basement where the insulation and air barrier are in the ceiling (or non-existent) is considered unconditioned space, and should not be included.
- A projecting mass such as a chimney should only be counted if it serves that particular level of the home.
- Porches that have a heat source (even if it is zoned separately), should be measured to the outside of the exterior walls.

Exceptions:

- None

Rationale:

- The easiest way to reduce the environmental impact of a home is to build smaller. A smaller home translates into less heating and cooling required, and fewer materials used in construction.
- A smaller home means a more efficient use of space, which typically correlates to reduced materials and resources to build and maintain the home (i.e., reduced usage of resources such as electricity, water and construction materials).

Considerations:

- None

Resources:

- TBD

1C-3_ Home utilizes incremental design techniques with documented provisions to expand to meet future growing needs

Requirements:

[Thank You Sponsors - Together We Improve Homes & People's Lives](#)

- Document provisions to expand to meet future growing needs. Show on drawings where future additions can be made (e.g., dash in dormer locations, future second story addition) where integration can be made without incurring large amounts of construction waste.
- Indicate how the plumbing and electrical design and installation is being done to anticipate future additions or changes to the home.
- Roof trusses or framing shall be designed to allow for future additions.

Exceptions:

- None

Rationale:

- This practice will save future resources and costs while reducing future waste, and encourages remodeling over purchasing a new home. In this way, occupants will make the most of the space they inhabit and only expand as needed.
- Planned remodeling and additions greatly reduce the environmental risks associated with construction sites.

Considerations:

- None

Resources:

- TBD

[Thank You Sponsors - Together We Improve Homes & People's Lives](#)

2 Site & Landscape

This section, Site and Landscape, is a series of interrelated measures to help responsibly manage the interaction between the built and natural environments, and to do so as early in the process as possible, usually in pre-construction design. Remodelers and homeowners are often unaware of the impact they may have on the environment and therefore ignore many of the following measures. Measures in this chapter include strategies for minimizing erosion and storm water runoff, using natural features to help manage building heating and cooling loads, and incorporating appropriate plantings into the landscape.

2PR- Perquisites

2PR-1_ No invasive species, as determined by the MN Extension Agencies, are planted. Existing species are removed.

Requirements:

- Existing invasive species are removed (i.e., the removal of a buckthorn hedge, or thistles)
- No new invasive species are introduced to the site
- Consult the MN Extension Agency map at www.extension.umn.edu/offices/

Exceptions:

- If the conditions of the property are such that a significant removal is possible, but a complete removal of the invasive species is not possible, those conditions should be documented and submitted at the GreenStar pre-construction meeting for review.

Considerations:

- Invasive species (non-native) are part of our planted world and we see them every day and may not even know it. Even some flowers that we view as attractive choke out native plants and contribute to the breakdown of our ecosystems
- Invasive species take considerable work, even well after the initial plants are removed, since they can continually send up new plant shoots
- Mass removal of plantings like buckthorn may leave the soil exposed and erosion could occur; care should be taken to stabilize the soil as appropriate.

Resources:

[Thank You Sponsors - Together We Improve Homes & People's Lives](#)

- TBD

2PR-2_ No cypress mulch

Requirements:

- No new cypress mulch added to the landscape.

Exceptions:

- Existing cypress mulch can remain as long as no new cypress mulch is added.

Rationale:

- Cypress harvesting is poorly regulated and can come from poorly managed forests that support a fragile ecosystem. Local mulch is readily available, and much of the wood construction debris can be site mulched as well.

Considerations:

- If construction waste is being mulched, verify that no CCA treated (pressure treated) wood, ACQ (Alkaline Copper Quaternary) treated (pressure treated wood), or creosote railroad ties are a part of the mulch plan. These three wood types in particular must be disposed of properly.

Resources:

- See these helpful resources for rain garden design, or visit a local gardening store for helpful information.
- For utility locations in the state of Minnesota, call 1 (800) 252-1166, or visit www.gopherstateonecall.org/.

2PR-3_ No railroad ties or other landscape materials may be used which contain creosote, chromated copper arsenate, or alkaline copper quaternary

Requirements:

- No use of phone poles, railroad ties or other landscaping posts which contain creosote, CCA, or ACQ can be placed in contact with soil, or exposed to rain.
- General contractor to sign-off on checklist

Exceptions:

- ACQ as decking sub-structure is allowed although not recommended

Rationale:

[Thank You Sponsors - Together We Improve Homes & People's Lives](#)

- Creosote and CCA are common wood preservatives in wood landscaping materials (especially ones not specifically intended for residential use). They can enter the respiratory and digestive system if touched; they are known carcinogens.
- Creosote and CCA can enter the air, soil and ground water when used as a landscape material; containment of creosote is difficult once this happens.
- Children are particularly susceptible to the ingestion of creosote and CCA as they may play on or around landscaping that may contain these preservatives.

Considerations:

- The recent use of ACQ (Alkaline Copper Quaternary) in the marketplace as an alternative to CCA raises concerns about its potentially harmful effects. GreenStar strongly suggests avoiding the use of any treated wood products when not absolutely necessary, especially when they may come in contact with the ground.

2PR-4_ Following construction completion, no part of the disturbed site is left uncovered or destabilized

Requirements:

- Depending on the intended purpose of the exposed area, seed with a drought tolerant grass mix, wildflower mix, or approved other. Make sure a temporary irrigation plan is in place to ensure seeding takes hold.
—OR—
- If planting is not the intended purpose of the exposed area, cover it with 4-6” of mulch or 2-4” of straw. This will help to control soil loss and also help avoid soil compaction until future site work takes place.

Exceptions:

- None

Rationale:

- Soil loss is a major contributor to impaired waterways and deteriorated air quality, especially in drought seasons.
- As of 2006, the PCA has determined that over 40% of Minnesota’s waterways are already impaired.

Considerations:

- None

Resources:

2A -SOIL AND PERMIABILITY

[Thank You Sponsors - Together We Improve Homes & People’s Lives](#)



Soil health and permeability are important aspects when building green. Healthy soil promotes healthy vegetation and species diversification. Native and climate appropriate plantings reduce the need for watering. Soil permeability increases demand on storm sewer systems, pollution and flooding of rivers and lakes, and water absorption, which minimizes run off. It also promotes replenishment of the aquifers, which are being depleted.

2A-1_ Soil tested and amended to achieve optimal nutrient level and structure

Requirements:

- Collect soil sample and provide it for testing to your local Extension Agency, Master Gardener, or certified landscape professional.
- Provide report
- Follow recommendations from your local Extension Agency. To locate the one closest to you, consult the MN Extension Agency map at www.extension.umn.edu/offices/

Exceptions:

- None

Rationale:

- Soil health can benefit the landscape immediately surrounding it. Poor soil conditions make it difficult for any plants to thrive or survive.
- Selecting plants appropriate for the soil condition can reduce the amount of amendments required and improve the plantings success rate.

Considerations:

- None

Resources:

- www.extension.umn.edu/offices/

2A-2_ No impervious surfaces constructed outside existing building footprint

Requirements:

- Do not add any hardscape anywhere on the lot.
- This credit is only available if there are no additions proposed to the building footprint
- This credit is only available if no additional steps, stoops, walkways, driveways, roof surfaces—such as sheds or covering existing decks—are proposed.
- Even open-cell pavers, stepping stones and the like have a percentage of impervious surface (hardscape) even though there is open space between them—using these materials does not qualify for this credit.

[Thank You Sponsors - Together We Improve Homes & People's Lives](#)

Exceptions:

- None

Rationale:

- The addition of hardscape reduces the ability for water to penetrate the soil, therefore, maintaining the amount of impervious surface or reducing it is desired.
- Impervious materials include concrete, stone, and class-5 aggregate.

Considerations:

- None

Resources:

- TBD

2A-3_ Total site has XX% permeable surface

Select one:

- 2A-3a_ 65% of undeveloped site is permeable
- 2A-3b_ 85% of undeveloped site is permeable
- 2A-3c_ 100% of undeveloped site is permeable
- 2A-3d_ Permeability of site is reduced

Requirements:

- A site inspection is required and must be part of the third-party field verification. The total site refers to property boundaries.
- You must include all covered structures (driveways, walkways, patios) on the property when determining the percentage of your site that is permeable. City sidewalks and curb-cuts are not included in this calculation.

Exceptions:

- None

Rationale:

- Having a site that has considerable pervious (permeable) surfaces is a benefit to storm water management as well as waterways and local aquifers.

Considerations:

- None

Resources:

- TBD

[Thank You Sponsors - Together We Improve Homes & People's Lives](#)

2A-4_ Permeability of the total site is increased by XX%

Select one:

- 2A-4a <20%
- 2A-4b <40%
- 2A-4c <60%

Requirements:

- If the site plan can demonstrate the overall reduction of existing hardscape either by the removal of hardscape, or by replacing it with a larger permeable area, then this credit can be achieved
- The site plan must show area of increased permeability and area calculations, as well as the strategies pursued
- Only stones and rocks 1/2" in diameter or greater will qualify for the replacement of walkways, or filler between pavers and be dust free
- An example of increasing permeability on the site is a 3'x3' area of concrete replaced with four 1'x1' concrete pavers, leaving 5 sq. ft. of area for plantings, mulch or grass.
- Another example would be replacing a concrete or asphalt driveway with porous asphalt or concrete and a properly designed drainage system that keeps 90% of the water on site in a typical rainfall event. (In Minnesota a typical rainfall event is 1/2".)

Exceptions:

- Stone fines between pavers (such as granite, concrete dust, class-5 aggregate, or similar) are not considered acceptable permeable materials.

Rationale:

- Increasing a site's permeability (reducing hardscape and increasing absorption) is a benefit to storm water management as well as waterways and local aquifers.
- Pair this credit with 1A-3 by having a high percentage of permeability and also reducing the amount of existing hardscape is of great benefit to the greater community.

Considerations:

- If you have a soil type that resists taking additional water (clay) you will need to install a proper drainage system to move the water into the ground fast enough to avoid losing the water to runoff. A permeable system that cannot drain will clog and may impact the durability of the installed material.

Resources:

- TBD

2A-5_ Keep excavated soils on site

[Thank You Sponsors - Together We Improve Homes & People's Lives](#)

Requirements:

- Protect removed topsoil from erosion by wind or rain with tarps or other suitable material.
- Clearly mark protected topsoil areas and communicate protection measures to all subcontractors.
- Show area on site plan that designates topsoil areas to be protected throughout all construction activities.
- Stockpiled soil must remain within 1/2 mile of the site during construction.
- Provide photograph of protected soils

Exceptions:

- None

Rationale:

- Keeping excavated soils on site reduces the amount of transportation needed to bring new soil to the job site when backfill is needed, thus reducing the amount of embodied energy of the overall project.
- Native soil will reduce the introduction of undesirable plant species and other pests.
- Amend soils as necessary to improve soil quality.

Considerations:

- None

Resources:

- TBD

2B - PLANTING/TREES

Preserving the trees and plantings we already have should always be an important part of each project. Established root systems hold the soil together and increase site permeability. Trees can also be strategic partners in improving the efficiency of a home. Taking a few steps to protect what is already present on the site and to think about how existing plantings are an important step in remodeling Green. It is understood that certain types of landscaping are undesirable in trying to achieve a Green project, therefore create a rationale for the project on the site plan if such a strategy is pursued.

2B-1_ 50% or more of the lot contains plants or trees other than turf

Requirements:

[Thank You Sponsors - Together We Improve Homes & People's Lives](#)

- Site plan illustrates planted areas and calculations show that 50% or more is planted with material other than lawn.

Exceptions:

- None

Rationale:

- Lawn mowing contributes to the use of fossil fuels (electric and gas). Even if a manual mower is used, what we think of as traditional lawn (lush and green all summer long) is not native to our state and requires a considerable amount of resources to be maintained.
- Introducing a wild flower mix, or other native plants contributes to the health of local ecosystems.

Considerations:

- None

Resources:

- TBD

2B-2_ Natural features on site (trees, prairie and wet lands, tundra and ecosystems) are protected during construction, regardless of project type or scope

Requirements:

- Document protection measures on Erosion Control Plan
- Photograph site during construction
- Trees designated for protection during construction (typically those with a diameter at breast height exceeding 2”) should be fenced at drip line (to include area extending in all directions from trunk) with firmly set-in fence posts (minimum 2x2 lumber)
- If you must drive equipment over sensitive areas such as tree roots, spreading 8” of wood chips down first will keep the soil from compacting and minimize any potential stress to the tree.
- If utilities must pass through a tree root zone, they are to be tunneled or hand dug

[Thank You Sponsors - Together We Improve Homes & People's Lives](#)



Exceptions:

- None

Rationale:

- Soil compaction around tree roots can contribute to a tree's slow demise. Reduce the possibility of soil compaction by protecting the unseen tree roots.
- Cutting tree roots can lead to a weakened tree making it susceptible to structure damage either during high winds or under extreme branch loads.
- Site protection of small and interior projects is commonly overlooked. However, deliveries, vehicles, and foot traffic can impact natural site features regardless of project size.

Considerations:

- None

Resources:

- TBD

2B-3_ No Heritage trees removed

Requirements:

[Thank You Sponsors - Together We Improve Homes & People's Lives](#)

- A heritage tree must be notated on the site or landscape plan, and field verified by a third-party reviewer. [Describe who the third party reviewer is].

Exceptions:

- Diseased trees or trees that can inflict potential damage to the home due to proximity, age, or other irreversible conditions. A written statement from a licensed arborist is required, and a replacement tree (one that can become a heritage tree) must be planted.

Rationale:

- This credit is available to all project types and scopes

A Heritage tree has any or all of the following features:

Diameter of at least 18” measured at 54” high (roughly chest height)

Special site location

Relation to a historical event

Unusual species or exemplary form of native species

A Heritage grove has any or all of the following features:

Mature and contains trees that are distinctive due to size, shape, species or age

Associated with a historical event

Relationship with a natural resource

(City Code Chapter 20.77.120 - Heritage Trees, Heritage Tree Nomination Packet, Urban Forestry Program, Vancouver)

Considerations:

- There may be instances when a heritage tree could be detrimental to a home, such as tree roots interfering with the sewer system, or significant branches touching the home. In these instances, it may be beneficial to consult with an arborist about significant pruning or full removal of a heritage tree.
- Heritage trees are often quite large and may play an active role in shading the home. Removal of the tree may cause a previously cool home to become overly warm in the summer, and care should be taken to evaluate the conditions and consider possible solutions for the home.

Resources:

- TBD

2B-4_ New plantings are compatible with soil type

Requirements:

- Consult the MN Extension Agency map at www.extension.umn.edu/offices/
 - Provide list of plantings used and show how they are compatible with soil type
-

[Thank You Sponsors - Together We Improve Homes & People's Lives](#)

Exceptions:

- None

Rationale:

- Soil compatibility will benefit the plantings' overall health, and minimize future replacement and water needs.

Considerations:

- None

Resources:

- TBD

2B-5_ Live trees from site are replanted or donated

Requirements:

- Describe plan for each tree to be relocated or donated.
- List intended recipients of donations.

Exceptions:

- None

Rationale:

- Replanting trees on the site is most desirable, however, if this is not possible, donating the removed plants and trees keeps them from becoming landfill or mulch
- Replanting landscape plants and trees does cause stress to the plants. Take extra care to minimize stress and provide ample initial water until re-established.

Considerations:

- Ornamental and native plants should also be considered for relocation or donation.

Resources:

- TBD

2B-6_ Restore damaged ecosystem (e.g., restore existing prairie or wet lands, establish wildlife habitat, remove extensive invasive plant species)

Requirements:

- Wildlife habitats can be restored by planting native plants or by leaving tracts of land undisturbed and protected.

[Thank You Sponsors - Together We Improve Homes & People's Lives](#)

- Approval from National Wildlife Federation or local agency overseeing habitat establishment
- Provide before and after photos, and list, detailing what was done.

Rationale:

- Construction and overbuilding is one of the main contributors of ecosystem and habitat depletion.
- Habitat and ecosystem establishment provides resources for otherwise homeless animal, plant and insect species.
- Tax credits may be available in your area.

Considerations:

- None

Resources:

- TBD

2B-7_ Participate in a wildlife conservation program

Requirements:

- Program literature, receipt of contribution, other materials showing membership or donation to a non-profit, DNR, or conservation organization.

Rationale:

- Construction and overbuilding is one of the main contributors of ecosystem and habitat depletion.
- Habitat and ecosystem establishment provides resources for otherwise homeless animal, plant and insect species.
- Tax credits may be available for membership in a program.

Considerations:

- None

Resources:

- TBD

2B-8_ Install a compost bin

Requirements:

- Show on Landscape Plan location of compost bin and type installed (e.g., home made, product literature)

[Thank You Sponsors - Together We Improve Homes & People's Lives](#)

- Provide photograph of compost bin.

Rationale:

- Compost bins are an excellent way to handle yard waste as well as provide an excellent source of nutrients for the garden.
- Read literature specifically geared for the type of compost bin installed on the site to get a good understanding of how a compost bin works and is maintained.

Considerations:

- Consider composting food scraps from the kitchen. See 9B-2 for more information.

Resources:

- www.eurekarecycling.org

2B-9_ Low-water/no-mow mix is used on 100% of turf areas

Requirements:

- Product label or literature of turf product used
- Landscape Plan illustrates area for turf

Rationale:

- Lawns require significant amounts of water to remain green, and as a lawn grows, it needs to be mowed. By reducing the amount of water a type of turf requires, and by installing a no-mow mix, a lawn then requires much less embodied energy than its high-water, high-mow relative.

Considerations:

- None

Resources:

- TBD

2B-10_ Edible landscape planting/food garden is installed

Requirements:

- Landscape Plan illustrates area for food garden or edible plants, and types of plants installed

Rationale:

[Thank You Sponsors - Together We Improve Homes & People's Lives](#)

- This credit is designed to encourage homeowners to grow and eat food grown on-site rather than food that has a high level of embodied energy, as well as the energy required to obtain the food through driving.
- Home gardens are a wonderful teaching tool for young and old alike. A heightened appreciation for growing food brings a better understanding to what it takes to fill a plate.

Considerations:

- Food gardens in the city need extra care. Keep them away from the road and the garage to avoid contaminating the plants.
- If you have rain barrels or other rainwater catchments remember that rainwater collected from an asphalt roof is not suitable for watering food gardens (water collected from steel, slate, wood, or clay tile roofs is OK to use).

Resources:

- TBD

2B-11_ Structure located in fire-safe area, away from highly-flammable trees and plantings (for rural projects ONLY)

Requirements:

- Significant trees are kept at a minimum of 50-100' clear of all structures
- Show a perimeter of non-combustible material around structures such as gravel or dirt

Rationale:

- This credit is designed for projects taking place in rural areas only. As the drought continues and forest fires become more common, it is increasingly important when choosing to build in wooded areas that we take the extra steps to ensure the long life of our homes and reduce the strain placed on our resources to protect them during a fire.
- Minimizing grasses near a house in fire-prone areas is an important strategy along with keeping small scrub trees that burn easily a safe distance from a house and out buildings.

Considerations:

- None

Resources:

- TBD

2B-12_ Design around or install deciduous trees on the south, east, and west sides of home

[Thank You Sponsors - Together We Improve Homes & People's Lives](#)

Requirements:

- Illustrate on the Landscape Plan the existing or future location of deciduous trees (a tree which loses its leaves in the winter months), the particular species, and the average height the tree will achieve.

Rationale:

- The shade provided in the summer will reduce the cooling load placed the home's cooling system, while allowing for maximum sun exposure during the winter months reducing the load placed on the home's heating system.
- This is a classic passive solar strategy, one which requires minimal maintenance over the life of the home.

Considerations:

- Shade trees are so important that the city of Minneapolis estimates a savings of over 25 million dollars annually in cooling costs as a result of our urban forest.

Resources:

- TBD

2B-13_ Existing and new deciduous trees shade 50% of sidewalks, patio or drive within five years

Requirements:

- Illustrate on the Landscape Plan the existing or future location of deciduous trees, the particular species, and the average height/size the tree will achieve in five (5) years (approximately)
- Provide calculations that show 50% shading

Rationale:

- This works to reduce the "Heat Island" effect created by hardscapes, particularly in urban areas where much of the environment is pavement or roof area. Heat island effect is an artificially-induced increase in the temperature of an area due to surfaces absorbing sunlight and holding the energy as heat.

Considerations:

- None

Resources:

- TBD

2B-14_ Design around or install coniferous trees on the north side of the home

[Thank You Sponsors - Together We Improve Homes & People's Lives](#)

(must not block solar access of neighbors)

Requirements:

- Illustrate on the Landscape Plan the existing or future location of coniferous trees (a tree which keeps its needles throughout the year), the species, and the average size of the tree

Rationale:

- Homes that have significant northern exposure can benefit from having a wind break on the north side of the home. Properly designed and maintained they can allow light to enter the home during all times of the year.

Considerations:

- Coniferous trees installed for this purpose must be of a variety that will grow tall enough to serve its purpose.

Resources:

- TBD

2B-15_ All plantings are kept at least 24” from the home

Requirements:

- Landscape Plan must show average size of plants and its minimum distance from the home
- Landscape Plan must show that soil protection is provided, and documentation of type of protection
- Must be 24” away from home at mature size
- No mulch may be laid as ground cover
- Provide photographs of installed strategies

Exceptions:

- Potted plants that can be easily relocated are allowed
- Plantings that require no watering and thrive in rocky conditions, such as ice-plant, sedum, and some other succulents, are allowed in a limited number.

Rationale:

- Plantings and mulch hold moisture in the soil
- Plantings encourage active irrigation of the soil close to the foundation
- Landscape plants too close to a home can allow for pest intrusion, stain on siding, and allow moisture and mold to penetrate siding materials

[Thank You Sponsors - Together We Improve Homes & People's Lives](#)

- Soil protection is just as important to keep water splash and soil from staining the home. Rocks can work as soil protection.

Considerations:

- Water moves through rock faster than soil. If you do not have large overhangs on the home, you should make sure the soil is adequately pitched away from the home prior to installation of the rock.

Resources:

- TBD

2B-16_ All plantings are kept at least 36” from the home

Requirements:

- Landscape Plan must show average size of plants and its minimum distance from the home
- Landscape Plan must show that soil protection is provided, and documentation of type of protection
- Must be 36” at mature size
- No mulch may be laid as ground cover
- Provide photographs of installed strategies

Exceptions:

- Potted plants that can be easily relocated are allowed
- Plantings that require no watering and thrive in rocky conditions, such as ice-plant, sedum, and some other succulents, are allowed in a limited number.

Rationale:

- Planting and mulch hold moisture in the soil.
- Plantings encourage active irrigation of the soil close to the foundation.
- Landscape plants too close to a home can allow for pest intrusion, stain siding, and allow moisture and mold to penetrate siding materials.
- Soil protection is just as important to keep water splash and soil from staining the home. A variety of rocks can work as soil protection.

Considerations:

- Water moves through rock faster than soil. If you do not have large overhangs on the home, you should make sure the soil is adequately pitched away from the home prior to installation of the rock.

Resources:

- TBD

[Thank You Sponsors - Together We Improve Homes & People's Lives](#)

2B-17_ Apply two inches of compost in the top 6 to 12 inches of soil in flower & vegetable garden beds.

Requirements:

- This credit is for areas designated for gardening and plantings only
- The compost must be tilled into the soil thoroughly to reduce plant burn

Rationale:

- Verify that the plants can tolerate the type of compost used
- It is encouraged to use locally made compost (from the back yard or a neighborhood pile).

Considerations:

- None

Resources:

- TBD

2B-18_ Use slow-release organic fertilizers or no fertilizer to establish vegetation

Requirements:

- This credit is for areas designated for gardening and plantings only
- The Landscape Plan must describe where the fertilizer shall be installed
- This credit is designed for new planting areas only

Rationale:

- If it Includes manure, describe on the Landscape Plan the type of manure used
- No phosphorous fertilizers may be used

Considerations:

- None

Resources:

- TBD

2B-19_ Community garden area

Requirements:

- Show garden on site plan, explain size and number of people it can serve, and describe how site is developed to support a garden.

[Thank You Sponsors - Together We Improve Homes & People's Lives](#)

- Build protection into covenants of development so that area remains community garden.
- Provide photograph of garden area.

Exceptions:

- None

Rationale:

- Community gardens provide areas for people to gather and strengthen bonds within a neighborhood. They are important vehicles to building neighborhood pride and conserving resources.
- Work with the neighborhood to designate a dedicated portion of land to community garden use, and preserve the plot with an agricultural easement or permanent restriction to insure its use in this manner for a minimum of ten (10) years. To qualify, the area of dedicated land must be greater than 10 sq. ft./dwelling unit.
- In consultation with residents, community gardening plots shall be constructed, including soil improvements and raised accessible beds, and provide start-up gardening supplies. Encourage organic gardening techniques.

Considerations:

- None

Resources:

- www.communitygarden.org/learn/what-is-a-community-garden/index.php

2B-20_ Use mulch ground from local tree trimming, on-site tree removal, or clean wood waste and gypsum (see 9A-3 for information and points)

2C - IRRIGATION

2C-1_ Develop landscape maintenance plan

Requirements:

- The landscape maintenance plan must be specific to the site and makes exclusive use of all-organic fertilizers
 - The landscape maintenance plan can be noted on the Landscape Plan
 - The maintenance plan must list watering, thinning, and winter bedding needs of the garden and plants
 - The Landscape Plan must illustrate location of hose bibs (sill cocks) and when the water must be shut off inside the basement prior to the first seasonal freeze
-

[Thank You Sponsors - Together We Improve Homes & People's Lives](#)

- The Landscape Plan should take into account rain barrels or other rain harvesting catchments.

Rationale:

- A landscape maintenance plan will help homeowners understand what is required for maintaining the life of the landscaping; this plan will help reduce watering needs as well as reduce the risk of over fertilizing.

Considerations:

- None

Resources:

- TBD

2C-2_ Landscape system that requires no municipally-supplied water or well water for irrigation (food gardens exempt)

Requirements:

- Provide photos of system
- Provide detailed description of system installed on landscape plan.

Rationale:

- Rainwater catchment systems are effective ways to irrigate without using drinking (potable) water

Considerations:

- If you have rain barrels or other rainwater catchments remember that rainwater collected from an asphalt roof is not suitable for watering food gardens.

Resources:

- TBD

2C-3_ Irrigation plan restricts watering to after dusk and before dawn

Requirements:

- An irrigation system on a timer is required
- Homeowner to sign-off on checklist that timer is set for nighttime hours only

Rationale:

- Water evaporates fastest during the daytime, sometimes evaporating before the water reaches the plants

[Thank You Sponsors - Together We Improve Homes & People's Lives](#)

- Watering during the day can lead to plant burn
- A drip irrigation system can reduce the amount of water evaporation, delivering more water to the root system faster

Considerations:

- None

Resources:

- TBD

2C-4_ Native and drought-tolerant landscape plantings make up minimum of xx% of non-paved areas (excluding turf)

Select one:

- 2C-4a_ <40%
- 2C-4b_ <60%
- 2C-4c_ <90%

Requirements:

- No irrigation system may be installed in the native/drought tolerant landscape, or a temporary system installed to establish plants only and a system removal date must be illustrated on the Landscape Plan
- Provide list of plants installed
- Calculate square feet of non-paved, non-turf areas planted.

Rationale:

- Drought tolerant plants incorporated with adaptable plants can withstand rainfall shortages and utilize less water for irrigation.

Considerations:

- None

Resources:

- TBD

2C-5_ Irrigation system that zones turf and bedding areas separately

Requirements:

- No irrigation may be provided to turf areas
- Landscape Plan must illustrate location of irrigation heads or location of system (i.e., location of irrigation hose if a drip system is installed)

[Thank You Sponsors - Together We Improve Homes & People's Lives](#)

- General contractor to sign-off on checklist

Rationale:

- Most turf mixes are designed to go dormant in dry summer months, usually to re-grow once moisture returns. Plants, on the other hand, may not be able to tolerate such a drought.
- Make sure irrigation heads are not aimed at sidewalks, buildings, or streets, causing runoff or damage of structures.

Considerations:

- None

Resources:

- TBD

2C-6_ Hydro zoning

Requirements:

- Landscape Plan should illustrate types of plants grouped together based on watering requirements (i.e. low water plants in one area, higher water plants in another)
- General contractor to sign-off on checklist

Rationale:

- This is a landscaping practice that groups plants with similar water requirements together in an effort to conserve water.
- May reduce the amount of irrigation required, either by reducing the number of irrigation heads, or by delivering less water to plants that need watering less than others.

Considerations:

- None

Resources:

- TBD

2C-7_ Irrigation systems

Select all that apply:

2C-7a Install drip system (Minimum 80% planting beds)

2C-7b Moisture/rain sensor added to any type of irrigation system (Minimum 80% planting beds)

[Thank You Sponsors - Together We Improve Homes & People's Lives](#)

2C-7c Electronic timer added to any type of irrigation system (Minimum 80% planting beds)

Requirements:

- A minimum of 80% of landscape planting beds must have a drip irrigation system to receive points
- Install a minimum of 2” of mulch over drip system to delay evaporation, and retain moisture levels
- Provide photographs
- Provide receipt

Rationale:

- Drip irrigation systems deliver water closer to the root system, and reduces evaporation

Considerations:

- None

Resources:

- TBD

2C-8_ Use irrigation specialist certified through EPA WaterSense program

Requirements:

- Provide copy of certification of specialist

Exceptions:

- None

Rationale:

- WaterSense was developed by the Environmental Protection Agency (EPA) to help homeowners reduce water consumption inside and outside.
- WaterSense Irrigation Specialists are certified through EPA for their knowledge of technology and landscaping to reduce water usage.

Considerations:

- None

Resources:

- www.epa.gov/watersense/pp/lists/irr_partners.htm

2C-9_ Install graywater irrigation system

[Thank You Sponsors - Together We Improve Homes & People's Lives](#)

Requirements:

- Provide receipt or documentation of type of graywater system used
- Provide documentation from local municipality that a graywater irrigation system is an approved method of irrigating

Rationale:

- Graywater systems have been established for many years in portions of the country that experience potable water shortages. By using wastewater from appliances, like washing machines, that is still safe for irrigation, we are able to conserve our fresh water resources. A graywater irrigation system shall be approved by local building and/or health departments, and, at a minimum, shall have a dedicated clothes washer box with 2” drain connected to a subterranean drain field. A separate clothes washer box shall be provided that connects to the sanitary drain system.
- See Resources for Minnesota Statute 115.59 for criteria
- Documentation: Performance measure - indicates size of system is balanced with load and demand
- Do not use detergents or soaps which contain phosphorus

Considerations:

- None

Resources:

- www.revisor.leg.state.mn.us/bin/getpub.php?pubtype=STAT_CHAP_SEC&year=2006§ion=115.59

2D - DECKS, PATIOS AND PORCHES

2D-1_ Use permeable paving for patios

Requirements:

- Provide area calculations showing a minimum of 30% permeability for method of paving
- Provide material specifications of paver material if manufacturer touts a highly porous surface
- No stone dust or fines may be used for fill between pavers
- No class-5 aggregate may be used for finished patio or walkway surface (class-5 underlayment is OK)

Rationale:

[Thank You Sponsors - Together We Improve Homes & People's Lives](#)

- Water has a greater opportunity for absorption if pavers achieve 30% permeability.
- Storm water runoff is reduced

Considerations:

- None

Resources:

- TBD

2D-2_ Wood use is kept at least 12” from soil

Requirements:

- Deck, patio, or porch posts must be held off ground minimum 12”
- Photo documentation or third-party field verification required

Rationale:

- Soil moisture, snow, and splashing can all lower the performance of wood, eventually leading to wood rot and shortening the life of the structure

Considerations:

- None

Resources:

- TBD

2D-3_ Use reclaimed material for deck or porch (80%)

Requirements:

- Describe where reclaimed material originates from
- Verify that reclaimed material is appropriate for outdoor exposure
- Explain species of reclaimed material, verify that the material is lead, CCA, and creosote-free

Exceptions:

- None

Rationale:

- Using wood that had a previous purpose keeps it from ending its life in a landfill. Reclaimed material reduces the need for virgin product and the energy needed to grow, extract, manufacture, and transport it.

Considerations:

[Thank You Sponsors - Together We Improve Homes & People's Lives](#)

- None

Resources:

- TBD

2D-4_ Decking is made from recycled content and has low-toxicity

Requirements:

- Must have a minimum of 40% recycled content (post-industrial/post-consumer),
- Must be chlorine-free, a non CCA-pressure treated lumber, contain no creosote, and certified by manufacturer or Scientific Certification System
- Deck ledger boards should attached to home with either minimum 3/8” spacers and full flashing shingle fashion from drainage plane to over framing or adhesive membrane strip taped to drainage plane running over ledger board and folded around joists over hanger with adhesive membrane cap patch over each joist.
- Provide receipt and material specifications

Exceptions:

- None

Rationale:

- Reducing the toxicity level of the materials chosen for a deck or porch floor reduces the exposure to the environment both on site and in it manufacturing process. It also reduces the exposure to humans and animals.
- Proper deck ledger board installation and flashing reduces water infiltration and eventual rot associated with poor installation.

Considerations:

- None

Resources:

- TBD

2D-5_ Wood to concrete connections prevent moisture wicking. (e.g. end grains have min. 3/8" air space. --AND-- side grains separated by 3/8" air space and/or flashing.)

Requirements:

- Provide receipt and material specifications
- Metal plate must be corrosion resistant
- Provide photograph of connections

[Thank You Sponsors - Together We Improve Homes & People's Lives](#)

Exceptions:

- None

Rationale:

- Concrete can wick moisture and in turn allow the wood to absorb it as well. By separating wood from the concrete with a metal plate, the ability for water to migrate is minimized.

Considerations:

- None

Resources:

- TBD

2D-6_ Deck ledger boards attached to home with either minimum 3/8" spacers and full flashing shingle fashion from drainage plane to over framing or adhesive membrane strip taped to drainage plane running over ledger board and folded around joists

Requirements:

- Rater to verify installation

Exceptions:

- None

Rationale:

- The ledger board-to-home connection has been a source of failure for many deck installations because they have failed to shed water away from the home but rather trap it behind the ledger board where it doesn't dry and can enter the home.
- Failure at this connection area can be very costly to repair, and durability is best ensured by proper water management during construction.

Considerations:

- None

Resources:

- TBD

2D-7_ Outdoor lumber used for landscaping made from wood treated with nontoxic preservatives, plastic/wood composites, or plastic (note: fasteners are product specific) (minimum 90% of all lumber)

[Thank You Sponsors - Together We Improve Homes & People's Lives](#)

Requirements:

- Rater to verify installation

Exceptions:

- None

Rationale:

- Less environmental impact.

Considerations:

- None

Resources:

- TBD

2E - EROSION CONTROL

2E-1_ Turf is not installed on slopes exceeding 25% rise

Requirements:

- Illustrate on Erosion Control/Landscape Plan with alternate plantings or type of retaining used

Exceptions:

- Standard turf alternatives such as buffalo grass and big blue-stem have deep root systems and can prove effective in moving water underground quickly. Written documentation from a landscape architect could allow for these turf-like plants to qualify for the credit.

Rationale:

- Turf is not a successful means of controlling erosion, especially in flash flood or long rain periods as their root systems are shallow.
- Plants with deeper root systems and planted closer together tend to hold soil better.
- Retaining walls designed properly for the height and percentage of the slope, and with proper anchoring, is an effective method on slopes over 25%.

Considerations:

- None

Resources:

- TBD
-

[Thank You Sponsors - Together We Improve Homes & People's Lives](#)

2E-2_ Apply mulch to at least 3” of all planting beds (no cypress mulch allowed)

Requirements:

- Mulch must be biodegradable to receive these points
- Landscape Plan must illustrate areas to receive mulch, type of mulch, overall depth, and long-term plan for periodically reinstalling mulch

Exceptions:

- None

Rationale:

- Mulch must be reinstalled to its original depth every couple of years due to mulch erosion.
- A minimum of 3” is desirable for moisture retention in soil.
- Mulch is a successful way to trap moisture in the soil, even in times of drought.

Considerations:

- None

Resources:

- TBD

2E-3_ Use site material as mulch for erosion control on steep slopes

Requirements:

- Illustrate on Erosion Control Plan areas to receive site material mulch
- Lay mulch around storm drains and in locations where silt fences do not hold up

[Thank You Sponsors - Together We Improve Homes & People's Lives](#)

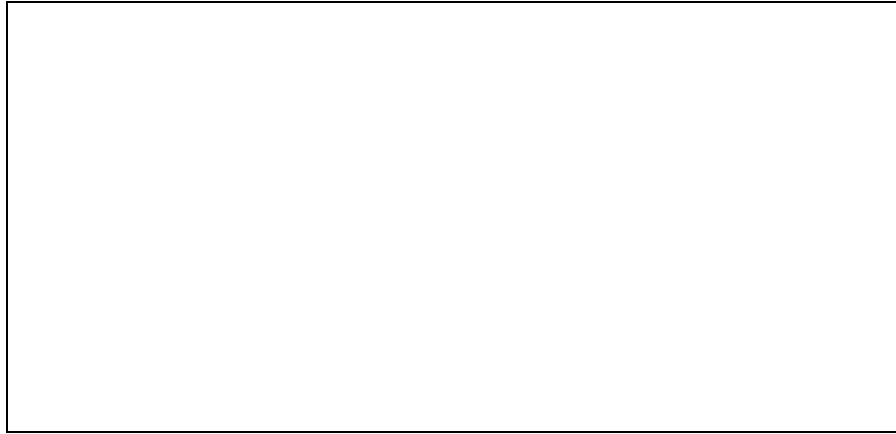

Exceptions:

- None

Rationale:

- Stumps and limbs that are not suitable for sawing, and cannot easily be re-purposed, can be chipped on-site. Consult with your local arborist before tree removal to determine the best course of action.
- Construction debris that has not been painted or sealed can be mulched for use on-site.

Considerations:

- None

Resources:

- TBD

2E-4_ Recycled materials used for silt fencing

Requirements:

- Recycled silt fence must be able to be reused more than twice
- Describe type of silt fence planned for reuse and method for storing it between job sites
- General contractor sign-off on checklist

Exceptions:

- None

Rationale:

[Thank You Sponsors - Together We Improve Homes & People's Lives](#)

- Rather than sending the silt fence to the landfill after each job, consider bringing it to the next job site to reduce waste

Considerations:

- None

Resources:

- TBD

2E-5_ Native landscaping is planted along 80% of shoreline

Requirements:

- This credit is for properties with lake or river shore
- DNR or other governing agency must grant approval for shoreline planting strategy—provide documentation of approval

Exceptions:

- None

Rationale:

- Shoreline degradation is responsible in part to the reduction water quality.
- Recreational and other water vehicles contribute to shoreline degradation, and planting the shoreline can help hold soft soils together.

Considerations:

- None

Resources:

- TBD

2E-6a_ At least one tree/4-5 shrubs are planted per 500 sq. ft. of the building footprint, plus the disturbed construction area

Requirements:

- Area calculations must be shown on landscape plan.
- General contractor to sign-off on checklist after planting is complete.

Exceptions:

- None

Rationale:

- Trees and shrubs help absorb carbon dioxide, a contributor to greenhouse gases.

[Thank You Sponsors - Together We Improve Homes & People's Lives](#)

- The disturbed construction area benefits from new plants or trees because they help hold soils together
- Avoid planting trees directly over main city water, sewer and gas lines and a safe distance from structures, depending on average diameter (drip line) of the trees.

Considerations:

- None

Resources:

- TBD

2E-6b_ Above plantings are native species

Requirements:

- Provide list of plants used

Exceptions:

- None

Rationale:

- Trees are a natural air purifier and absorb carbon dioxide, a known greenhouse gas.
- Native trees are adapted to the area climate and will need less water over time.

Considerations:

- None

Resources:

- TBD

2E-7_ Long-term erosion is reduced through terracing, retaining walls, landscaping, or other re-stabilization techniques

Requirements:

- Landscape Plan must indicate elevation change in property and describe strategy to stabilize the soil.
- Provide photograph of installed measures

Exceptions:

- None

Rationale:

[Thank You Sponsors - Together We Improve Homes & People's Lives](#)

- Erosion from a yard negatively impacts the community around it through the loss of beneficial topsoil, potential increase in unwanted chemicals from lawns, and excess water and sediment entering storm sewers and waterways.
- The goal in storm water management is to keep rainwater on-site so that it soaks into the ground and contributes to the replenishment of the aquifers.

Considerations:

- None

Resources:

- TBD

2F - RAINWATER HARVEST

2F-1_ Roof water drainage system that captures xx% of roof area for irrigation use

Requirements:

2F-1a_	20%
2F-1b_	50%
2F-1c_	90%

Requirements:

- Provide photographs or receipts showing roof water drainage system for irrigation.
- Provide calculations that show the percentage of roof water that can be captured.

Exceptions:

- None

Rationale:

- Storm water management practice, in which captured water is reused as irrigation.
- Utilize rain barrels at most of the downspouts, depending on roof area
- Hoses can be attached to rain barrels for regular watering
- Water catchment systems are similar to rain barrels but are on a much larger scale and require significant land area. These are more suited to rural or farm locations.

Considerations:

- If you have rain barrels or other rainwater catchments, remember that rainwater collected from an asphalt roof is not suitable for watering food gardens.

Resources:

[Thank You Sponsors - Together We Improve Homes & People's Lives](#)

- TBD

2F-2_ Vegetated or Green roof system is installed on XX% of roof area

Select One:

- | | |
|--------|-----|
| 2F-2a_ | 20% |
| 2F-2b_ | 50% |
| 2F-2c_ | 90% |

Requirements:

- Building plan showing construction method, percentage of roof area covered, and type of vegetated roof system
- Provide photograph of system

Exceptions:

- None

Rationale:

- These installations slowly filter rainwater through roof plantings and reduce heat island effect by approximately 30%.
- Proper engineering of the roof system must occur in order to support additional weight of the vegetated roof. Consult a structural engineer prior to construction.
- Proper plantings make a vegetated roof successful. In some instances, irrigation systems are installed in order to keep plants viable.

Considerations:

- None

Resources:

- TBD

2F-3_ Vegetated or Green roof is pitched

Requirements:

- A slope greater than a 6/12 pitch requires additional documentation to show its ability to retain the soil and plantings in a larger than normal rainfall event (1")
- Provide building plan and photograph of installed system

Exceptions:

- None

[Thank You Sponsors - Together We Improve Homes & People's Lives](#)

Rationale:

- A slope greater than a 2/12 pitch aids in moving bulk water away from the home.

Considerations:

- None

Resources:

- TBD

2F-4_ Rain garden (captures XX% of roof runoff for 1/2" rain event)

Select One:

- | | |
|--------|-----|
| 2F-4a_ | 20% |
| 2F-4b_ | 50% |
| 2F-4c_ | 90% |

Requirements:

- Landscape Plan must show area and size of rain garden.
- Calculations must show that rain garden will hold the quantity of roof run-off for no more than 24 hours.
- Provide photograph of installed garden.

Exceptions:

- None

Rationale:

- Filters pollutants, generates bio systems and prevents flooding.
- Many resources are available to help design and size a rain garden in order for it to work properly during a heavy rain.
- A landscape architect or designer can provide proper documentation and design specifications for a rain garden.

Considerations:

- None

Resources:

- TBD

2F-5_ Install French drains to manage rainwater and to keep storm water on-site

Requirements:

[Thank You Sponsors - Together We Improve Homes & People's Lives](#)

- Calculate the amount of water the French drain will hold and describe water source and predicted water that will come from the source (roof, sidewalk, driveway)
- General contractor to sign-off on checklist

Exceptions:

- None

Rationale:

- Filters pollutants, generates bio systems and prevents flooding.

Considerations:

- None

Resources:

- TBD

2G-GRADING/DRAINAGE

2G-1_ Minimum of 50% (75% over 1 acre) of lot is protected from all grading and tree clearing

Requirements:

- For lots larger than 1 acre, protect 75% of the area in order to receive these points.
- Indicate area under protection on site plan and describe strategy on to keep area protected from grading or tree removal during construction.
- General contractor to sign-off on checklist

Exceptions:

- None

Resources:

- Preserves natural landscape features and mature plantings.

Considerations:

- None

Resources:

- TBD

2G-2_ Retill top twelve inches of soil after construction

[Thank You Sponsors - Together We Improve Homes & People's Lives](#)

Requirements:

- Indicate the strategy on landscape plan
- General contractor to sign-off on checklist

Exceptions:

- None

Rationale:

- Construction activity can leave the soil compacted. Tilling the soil provides air to the soil as well as allows it to absorb water more efficiently. New plantings will have a better chance at being established and long-term water needs are less than if the soil is not tilled.

Considerations:

- None

Resources:

- TBD

2G-3_ Bearing capacity and soil permeability of the site are tested

Requirements:

- A certified soil testing agency must take soil samples or borings to determine soil bearing capacity
- Results must be submitted with Erosion Control Plan

Exceptions:

- None

Rationale:

- The bearing capacity of soil is an important consideration in construction projects. Temporary support structures such as formwork for foundations must have proper support during construction.
- Poor soil types, and low-bearing capacity can lead to structural failure over time.
- Many homes situated in abandoned lake beds may require the use of pilings or helical piers if a significant addition or new foundation is to be built.

Considerations:

- None

Resources:

[Thank You Sponsors - Together We Improve Homes & People's Lives](#)

- TBD

2G-4_ Reuse all site topsoil, if site disturbance occurs

Requirements:

- Landscape Plan must illustrate plan of action to maintain topsoil on site
- Points are only available if the topsoil is reused in its site of origin
- General contractor to sign-off on checklist stating that measures were taken

Exceptions:

- None

Rationale:

- Keeping topsoil on-site reduces the amount of embodied energy needed to bring new soil to the site.
- Topsoil contains valuable nutrients and should be reused whenever possible.
- Soil from outside the site of origin can lead to transference of undesirable plant species and insects.

Considerations:

- None

Resources:

- TBD

2G-5_ Patio slabs, walks and driveway shall be sloped a minimum of 1/8" per foot away from house

Requirements:

- Site/Landscape Plan showing construction note
- Rater verification

Exceptions:

- None

Rationale:

- Keeping water moving away from a structure will help reduce water infiltration in a foundation.

Considerations:

- None

[Thank You Sponsors - Together We Improve Homes & People's Lives](#)

Resources:

- TBD

2G-6_ Land is re-graded (or terraced) to slope away from house (minimum 5% slope 10' away from foundation walls) (minimum 6" within first 10')

Requirements:

- Site/Landscape Plan showing construction notes
- The slope must be designed to enable proper drainage
- Where there are setbacks, limit space to less than 10' and provide swales or drains designed to carry water from foundation
- Rater verification

Exceptions:

- None

Rationale:

- Proper drainage coupled with gutters and downspouts can help keep moisture and water out of basements and away from foundations
- Over time, the grade may lessen, requiring the addition of new topsoil to help keep water away from foundations

Considerations:

- None

Resources:

- TBD

2G-7_ Slope garage floor toward main vehicle entry doorway, or integrated floor drains, minimum 1/8" per foot

Requirements:

- Garage floor plan must have construction notes stating slope and direction of drainage
- Floor drains may not connect to the storm sewer system
- Rater verification

Exceptions:

- None

[Thank You Sponsors - Together We Improve Homes & People's Lives](#)

Rationale:

- Improper drainage can lead to undesirable standing water inside the garage and potential rotting of wall studs.

Considerations:

- None

Resources:

- TBD

2G-8_ Drainage system at base of garage and driveway that captures 90% of run-off and keeps it on-site

Requirements:

- Verify with local municipality construction requirements for integrated floor drains in a garage
- Illustrate on garage floor plan and on site plan location and slope of floor and driveway drains
- Drains may not connect to the storm sewer system
- Drainage must be designed to retain the water from an average rainfall event (in Minnesota the average rainfall event is 1/2")

Exceptions:

- None

Rationale:

- Runoff from garage floors and driveways can contain vehicle debris and other contaminants like oil, radiator coolant, and salt. Keeping the contaminants on-site will help reduce the ability for them to enter the sewer system.
- Some municipalities may have strict requirements for capturing garage runoff and how it is handled once it is captured.

Considerations:

- None

Resources:

- TBD

[Thank You Sponsors - Together We Improve Homes & People's Lives](#)

Introduction to 3 & 4

Introduction to High Performance Floor, Wall, Ceiling and Roof Assemblies

The building envelope is made up of the floor, wall, ceiling and roof assemblies that contain the conditioned spaces of the house, and they prevent elements of the exterior spaces or earth from getting into the house. For example, an interior partition wall would normally NOT be considered part of the building envelope.

Creating a High Performance Building Envelope is one of the most important Green building strategies that exists. In general a High Performance Building Envelope has the following characteristics.

- Sheds bulk water effectively.
- Prevents water vapor from leaking into or across it, but has an ability to dry out when and if moisture does enter it.
- Prevents heat in all of its forms (e.g., convective, conductive, and radiant) from flowing across it.
- Prevents air from leaking into or through it. Meets structural requirements while being as efficient as possible with the amount of natural resources and embodied energy necessary to construct it.
- Serves as an effective sound barrier.
- Does not off gas harmful chemicals.
- Provides security.

It is also very important to use the best Green strategies possible when designing and building the interior floor, wall, and ceiling assemblies; however, they do not have nearly the same impact on overall energy efficiency, durability, and comfort of the house.

As with nearly everything related to building design and construction, “Holistic Systems Thinking” is important. One must recognize that the components of the building envelope itself are a subsystem within the larger system of the house, and of course the “House System” resides within the larger ecosystem. This envelope system has a dynamic interaction with the climate in which it is built, Indoor Environmental Quality (IEQ), mechanical systems in the home, etc.

When remodeling, it is important to understand the existing conditions and how well they are performing before making alterations that could upset the balance of systems currently in place. On the other hand, as is often the case, it is also important to recognize when the existing systems are NOT operating well, in which case improvements should be made.

It is important to understand that altering any one component of an existing building envelope (i.e., adding insulation to the wall cavity) can drastically change the way the envelope performs,

[Thank You Sponsors - Together We Improve Homes & People's Lives](#)

and can sometimes have undesired and unforeseen consequences. In particular, the introduction of new insulation and vapor barriers to walls, roofs, and joists must be carefully considered to ensure there will not be any negative side effects related to moisture and indoor air quality.

Air Barriers and Vapor Barriers (Retarders)

The use of air barriers and vapor barriers in building systems is often a confusing and controversial topic, and so far there is not any ONE system that everyone can seem to agree upon.

Here are some facts.

- The physics of water vapor movement through diffusion are such that water vapor will always move from a higher concentration to a lower concentration and from a higher temperature to a lower temperature.
- Air will always move from a place of higher pressure to a place of lower pressure.
- Everyone seems to agree that building assemblies should be protected from wetting by air transport of moisture and vapor diffusion.
- Everyone seems to agree that a best-case scenario would be to prevent building assemblies from getting wet from either the interior or exterior in the first place, but when they do get wet (and they almost certainly will at some point), or if they start out wet due to conditions during construction, they should have an adequate ability to dry to the interior and exterior.
- What is considered an adequate ability to dry is often debated.
- Everyone seems to agree that a good air barrier in the thermal envelope of the house is a good idea no matter what the climate is. Air barriers are useful in building systems because when air flows from conditioned space to unconditioned space it can carry a lot of heat energy and moisture with it. This wastes a lot of energy, which we know has many negative side effects related to financial and environmental costs. The problem with the moisture air carries relates to the potential for that moisture to condense within the building assembly as the air passes through it. This is a dangerous situation, which often results in durability problems and mold-related health issues.
- There is a lot of inconsistency in terminology that people use on this issue. The definition of a vapor barrier is one that stops vapor diffusion completely, but very few materials do this. The ability of a material to stop vapor diffusion is usually described by its “perm” rating. The definition of a vapor barrier in most building codes is a material whose perm rating is 1 or less. Today in the building science profession there is a movement to use more precise language, such as the term “vapor retarder” and materials are put into categories according to their rating. ASTM E-96 (Standard Test Method for Water Vapor Transmission of Materials) is used to determine perm rating.
 - Class 1 Vapor Barrier (vapor impermeable) material ≤ 0.1 perm
- E.g., some sheet polyethylene, non-perforated aluminum foil, glass, sheet metal.
 - Class 2 Vapor Retarder (vapor semi-permeable) $0.1 \text{ perm} < \text{material} \leq 1.0$ perm
- E.g., some bitumen impregnated Kraft faced fiberglass batts, some sheet polyethylene, and low perm paint.
 - Class 3 Vapor Retarder (vapor semi-permeable) $1.0 \text{ perm} < \text{material} \leq 10.0$ perm

[Thank You Sponsors - Together We Improve Homes & People's Lives](#)

- E.g., some bitumen impregnated Kraft faced fiberglass batts, most latex or enamel paints, plywood, OSB, un-faced expanded polystyrene (EPS) un-faced extruded polystyrene (XPS) ~ 1" thick or less, fiber-faced isocyanurate, heavy asphalt impregnated building papers (e.g., #30).
 - Class 4 Vapor Retarder (vapor permeable) 10.0 perm < material
- E.g., unpainted gypsum board, plaster, un-faced fiberglass insulation, cellulose insulation, synthetic stucco, some latex paints, lightweight asphalt impregnated building papers (e.g., #15), asphalt impregnated fiberboard sheathing, and house wraps.
- Some materials have the ability to change their permeability based on the moisture levels present. The benefit of these is that they tend to perform like a higher class vapor retarder to prevent general vapor diffusion, but if a high concentration of moisture managed to get into the building assembly, they would allow this to dry out more readily than a vapor retarder that had a single low perm rating. Some examples include, plywood, bitumen impregnated kraft paper, and some plastic sheeting.
- The capacity for moving air (air leaks) to transport moisture is far greater than the capacity of vapor diffusion to transport moisture. Thus a good air barrier is very important for moisture control.
- Good air barriers are NOT always good vapor barriers; a wall full of open cell spray foam or densely packed cellulose insulation are good air barriers, but they would typically be considered Class 3 Vapor Retarders.
- Good vapor barriers are usually good air barriers, but careful installation to ensure there are not leaks at the seams and edges is often difficult; 6 mil polyethylene typically has about 0.6 perm rating and therefore it meets vapor barrier requirements for most building codes. However, air leaks at penetrations or seams can result in tremendous amounts of moisture to be carried into the building assembly by the moving air.
- Sheet-type vapor barriers should typically be placed on the warm side of the insulation, however, in climates like Minnesota, where the warm side changes throughout the year, it can be difficult to determine which side is best. Since the heating season in Minnesota clearly outweighs the cooling season, when sheet vapor barriers are used, they are installed on the side of the insulation that is warm during the heating season. Even though the Minnesota cooling season is relatively short, it can often be very hot with high relative humidity. It is this widely diverse climate that makes it extremely difficult to have building envelop assembly that performs equally well during both times of the year.
- Sheet vapor barriers typically do not allow drying to take place very well when moisture does get into the building assembly.

Insulation

Effective insulation is a very important part of any High Performance Building Envelope.

[Thank You Sponsors - Together We Improve Homes & People's Lives](#)

Insulation is installed in walls and ceilings to slow down the flow of heat between the interior and exterior of the house. R-Value is the term used to measure a material's insulating value. The higher the "R", the higher the resistance to heat, and therefore the better the insulation.

Each time the R-Value is doubled the heat loss is cut in half. Doubling R-1 to R-2 cuts the heat loss in half, but so does doubling R-20 to R-40. It costs much less to bring R-1 to R-2 than to bring R-20 to R-40, and going from R-1 to R-2 saves much more energy. Depending on the cost per "R", a point is reached where your investment in increased insulation will never be returned. You can readily see the diminishing returns for heaping on more and more insulation. Also, when considering loose fill or batt insulation in an attic application, the more insulation that is heaped on, the more all of it compresses due to its own weight. This increases the amount of insulation material required to achieve a specified thickness and R-value. Insulation recommendations are made with these cost/benefit calculations in mind.

The amount of insulation that you will install is only one concern. The material that you install is an equally important decision. Fiberglass, both blown and batts, cellulose, and mineral wool all have approximately the same R-Value per inch—about R-3 to 3.5. Polyisocyanurate energy sheathing has an R-Value of about 6 per inch. Drywall, sheathing, and framing lumber all have an R-value of about 1 per inch. Fiberglass and mineral wool tend to allow air convection in their fibers to degrade their "R" value, while cellulose is much more solid and resists that movement. Energy sheathing, while expensive, allows no internal air convection and therefore contributes more to the overall quality of the wall. The factors that would recommend one material over another are: environmental friendliness, ease of installation, durability, cost per installed R-Value, and the ability to reduce convective air movement.

Installation of insulation is very important to how well it will perform. The general rule for optimal effectiveness is that it needs to physically touch the location of the energy loss (this is the backside of the wall, ceiling or floor finish material, depending on the application). This is one of the biggest drawbacks to batt insulation. Unlike blown-in insulation or spray foam insulation, it is not possible to fit batts as tight around all of the other components of the building assembly. Furthermore, if the batts are fiberglass, they allow convective currents of air to flow through them, which degrades their effective R-value even further.

Since effective insulation is a very important part of any High Performance Building Envelope, it is something that most Green building program users want to be able to see at glance. However, the individual credits that relate to insulation are located with the different assemblies where they belong from a building design and construction standpoint. Therefore, this summary table is being provided to allow

[Thank You Sponsors - Together We Improve Homes & People's Lives](#)

users to do a quick overview of insulation recommendations without having to read through every section related to the building assemblies that affect their project.

The following table gives the recommended minimum insulation levels that should be met or exceeded whenever possible, recognizing that, at times, remodeling presents us with a unique set of pre-existing conditions that may make it difficult or impossible to meet these levels. The insulation shall be continuous (no gaps or missing pieces) and contiguous (in contact with the air barrier). For example, in the floor of a room-over-garage, the insulation must be in continuous contact with either the garage ceiling or sub floor sheathing. No paper-faced batts are allowed in contact with concrete foundation walls or in contact with sub floor in crawlspace applications (EC, 13.1).

Recommended (minimum) Insulation Levels

Exterior walls and band joist	R19
Flat ceilings	R49
Sloped ceilings	R38
Cantilevered floors	R38
Framed floors	R19
Foundation walls	R10
Attic kneewalls	R19
Insulated sheathing on metal-framed exterior walls	R10

The correct R-value for reflective insulation or any other type of insulation can be found on the manufacturer's FTC Fact Sheet, which is required to be available to all customers by the Federal Trade Commission R-Value Rule. The Minnesota Department of Commerce maintains a list of residential insulation products that comply with the Minnesota Residential Thermal Insulation Standards program. Call the Energy Information Center at (651) 926-5120 or 1 (800) 657-3710.

[Thank You Sponsors - Together We Improve Homes & People's Lives](#)

Company Name

Company Address

Company Phone

This is soy-base polyurethane two-part spray foam insulation

Insulation Thickness	One Inch	3 1/2 Inches	5 1/2 Inches
R-Value	3.8	13.3	20.9

This is a one-half pound per cubic foot, open-cell Polyurethane Insulation that is delivered as liquid in two separate drums. The material is sprayed, using special equipment, onto the surface being insulated in a texture consistent with paint. It expands to 100 times its volume in seconds, forming a block of insulating material.

Read This Before You Buy

What You Should Know About R-values

The chart shows the R-value of this insulation. R means resistance to heat flow. The higher the R-value, the greater the insulating power. Compare insulation R-values before you buy. There are other factors to consider. The amount of insulation you need depends mainly on the climate you live in. Also, your fuel savings from insulation will depend upon the climate, the type and size of your house, the amount of insulation already in your house, and your fuel use patterns and family size. If you buy too much insulation, it will cost you more than what you'll save on fuel. To get the marked R-value, it is essential that this insulation be installed properly.

3 Improvements to Existing Floor, Wall, Ceiling & Roof Assemblies

How To Use These Sections

[Thank You Sponsors - Together We Improve Homes & People's Lives](#)

Similar to other sections, there are some pre-requisites that must be met.

The sections for elective credits are divided according to the major pieces of the building envelope. Since remodeling is often a combination of modifying existing and building new, and since the strategies for each of these situations are often different, they are separated in this program. For example, Improvements to Existing Foundation Walls is separate from New Foundation Walls. Section 3 identifies strategies for improving existing assemblies, while Section 4 addresses best practices for new construction such as an addition. As one might expect, the Section 4 strategies align very closely with the Minnesota GreenStar New Homes program.

Section 3 covers improvements to ALL existing floor, wall, ceiling and roof assemblies, not just those which make up the building envelope.

3PR -PREREQUISITES

3PR-1_ Insulating and/or finishing a basement can be risky. If choosing to insulate or finish a basement anyway, perform thorough risk assessment of existing conditions and systems prior to doing basement finish work

Requirements:

1. Document bulk water intrusion risk, existing protection and any protection being added.
2. Document existing and proposed drying mechanism for walls and floor.
3. Perform Calcium Chloride Measured Vapor Emission Rate (MVER) test on floor - ASTM F 1869-04.
 - Perform a minimum of three (3) tests for the first 1,000 square feet and an additional test for every 1,000 square feet beyond.
 - Test results must be 3 lbs. or less of moisture per 1,000 square feet of area in 24 hours.
 - Install a barrier membrane if more than 3 lbs.
 - Installation specifications for the flooring being installed will have different moisture (MVER) tolerances.

Tip: Points can be obtained, and these documentation requirements can be met, by doing measure: “1B-1_ Document all existing conditions, equipment and assemblies in house.”

Exceptions:

- Calcium Chloride Test is NOT required for GreenStar if slab is being replaced AND new slab has proper vapor retarder installed below it.

[Thank You Sponsors - Together We Improve Homes & People's Lives](#)

Note: If finish material is being added to a new slab, the Calcium Chloride Test may be required by the manufacturer of the finish material. Verify with manufacturer & installer.

Rationale:

Insulating and/or finishing a basement are heavily debated issues from the Green building perspective.

It is very risky if the intention is to finish the basement as living space, if at least one of the following systems does NOT exist:

1. Exterior bulk water management system consisting of foundation waterproofing and footing drain tile—OR—exterior drainage plane and drain tile.
2. Interior bulk water management system consisting of drainage plane on wall, which allows drainage into drain tile with filter fabric under slab, sump pump, and sub-slab soil gas ventilation system.

On the positive side, it is very Green to improve the energy efficiency of this area of the house that is typically not very well insulated or airtight. Also, finishing a basement falls into the Green strategy of increasing living space in a house without increasing the footprint or volume of the house.

The potentially negative side of finishing a basement has to do with the potentially harmful indoor environmental situation that can arise if bulk water and water vapor are not managed well with regard to how the floor, wall, and ceiling assemblies are designed, and the properties of the materials used in them.

If these issues seemed challenging on above-grade walls, basements take this challenge to an even a greater level. They should be addressed with great care, and consulting with a knowledgeable professional is highly recommended!

The following are some assumptions about basements in Minnesota that should always be addressed when insulating or finishing a basement.

- Bulk water will make its way through the wall at some point in the life of the foundation. A good exterior bulk water management system can make this less likely, but designing the inside of the wall to accommodate bulk water if and when it ever does is the prudently safe approach to take.
- Moisture levels can fluctuate greatly. The MVER test is a good way to determine if the slab is dry at a particular time, but that could change if a proper bulk water management system is not in place and weather is rainy for a period of time. Also, it may appear as though no bulk water ever comes through the walls, but that could also change if there is a water leak such as a garden hose left running near the

[Thank You Sponsors - Together We Improve Homes & People's Lives](#)

foundation and saturates the outside of the foundation in a way that had not happened prior.

- Radon levels can fluctuate over time as well. Cracks in the floor slab or foundation wall that are common over time, can let more radon in. Also radon seepage through the soil under or to the side of the foundation can change as well.

Taking care to understand the risks of finishing a basement cannot be emphasized enough.

Considerations:

- Explained in Rationale paragraphs above.

Resources:

- See Basement Risk Assessment Worksheet in Checklist or from GreenStar.
- Hiring a Rater to perform this assessment may be a good idea if others on the design team are not qualified to perform this assessment.
- TBD (perhaps add some drawings of recommended foundation wall sections as described above.)

3PR-2_ & 4PR - 2_ Use Integrated Pest Management (IPM) methods to prevent pest entry

Requirements:

1. Seal utility and joint penetrations. Use filler strips of metal or wood for larger openings. Use caulk or expanding foam insulation for smaller openings.
2. Install metal screens on appliance vents to keep out rodents and large pests. Be sure the screen does not restrict air flow more than what is allowed by the appliance manufacturer.
3. Protection for foundation insulation such as metal lathe over foam board.
4. Repair any areas on the home where moisture may have an opportunity to enter the building assembly. -- Most pest species of termites have a high moisture requirement for the colony to survive. They have thin cuticles (skin), which must not dry out, or the termite will die.
5. Design and construct any new areas of the project carefully to prevent water and moisture entry.

Exceptions:

- In remodels, opening existing inaccessible areas is not required, but if they are already open, they should be inspected and then sealed properly when reclosing them to prevent moisture and pest and entry.

Rationale:

[Thank You Sponsors - Together We Improve Homes & People's Lives](#)

- The intent of this Pre-Requirement is to ensure that at least the minimum IPM strategies are being implemented -- The scope of IPM strategies actually goes beyond the design and construction of building assemblies. For example, the landscape design can also have a major impact on the likelihood of pests entering the home as well.
- Due to the risk of termites, IPM strategies for southern climates (where termites exist) are typically more developed and common than in Minnesota. However, other pests are common in Minnesota, and it is prudent to use well-developed IPM strategies, which are effective against Minnesota pests as well. Furthermore, termites themselves appear to be migrating north into the southern areas of Minnesota.
- Keeping pests out of homes in the first place reduces or eliminates need for pesticides, pest management devices, and tracking down locations of entry for pests.

Considerations:

- Physical barriers are preferred over chemical barriers where possible. The use of pesticides can have negative side effects on human health and the environment and need to be weighed carefully when choosing to use them.
- Most insects (and mold for that matter) require moisture and a food source. Thus the importance of keeping moisture out of building assemblies cannot be over stated!

Resources:

- See International Residential Code (IRC) Fig. R 301.2(6) for termite infestation map.
- See also Austin Energy Company website:
www.austinenergy.com/energy%20Efficiency/Programs/Green%20Building/Sourcebook/integratedPestManagement.htm
- www.termiteinstitute.com
- www.termimesh.com

3PR-3_ & 4PR - 3_ Structural plywood & OSB must conform to PS1 and PS2 thus shall be made with non-urea formaldehyde, exterior-type adhesives

Requirements:

- GC Sign Off

Exceptions:

- None

Rationale:

- Exterior grade adhesives are designed to hold up under more extreme conditions than interior-type adhesives.
 - Exterior grade adhesives are typically NOT urea-formaldehyde based and therefore pose a much smaller risk regarding the negative side effects of formaldehyde off gassing.
-

[Thank You Sponsors - Together We Improve Homes & People's Lives](#)

- Attention to this detail is sometimes overlooked, and it therefore warrants being mentioned here.

Considerations:

- None

Resources:

- Exterior-type adhesive is evidenced by the appearance of “Exposure 1” or “Exterior” in the panel trademark.
- Standards governing the manufacture and/or performance of structural plywood include *Voluntary Product Standard PS 107 for Structural Plywood* and *Voluntary Product Standard PS 2, Performance Standard for WoodBased Structural Use Panels*. Structural plywood trademarked by APA under these standards is manufactured only to Exterior or Exposure 1 bond classifications and is therefore produced with exclusively phenolic adhesives.
- Standards governing the manufacture and/or performance of OSB include *Voluntary Product Standard PS 2, Performance Standard for WoodBased Structural Use Panels*. This standard requires OSB to meet the Exposure 1 bond classification and therefore only permits moisture resistant adhesives such as phenolic or MDI adhesives.

3PR-4_ & 4PR - 4_ New attached garage only allowed if house has pre-existing attached garage. All new attached garages must be built with breezeway/mudroom and other measures to minimize the potential for garage pollution to enter the house.

Requirements:

1. Breezeway/mudroom required between the garage and the home.
 - Provide airtight, self-closing doors between breezeway and home and between breezeway and garage.
 - Hard surface flooring (i.e., no carpet) required in breezeway.
 - Walk-off mat required in breezeway.
2. Install air barrier, seal common walls, ceiling and penetrations prior to insulating.
3. Install ENERGY STAR rated exhaust fan in garage.
 - Option 1: 25 CFM continuous operation.
 - Option 2: 100 CFM designed to run intermittently based on motion sensor.

Exceptions:

- Existing attached garages may remain
- Homes with an attached garage that is converted to living space, may build a new attached garage provided it meets the requirements.
- Building a new detached garage also allowed.

[Thank You Sponsors - Together We Improve Homes & People's Lives](#)

Rationale:

- Many of the compounds in and around garages are known carcinogens.
- Attached garages represent a major source of pollutants that can easily make their way into the house. The above measures help to minimize the risk as much as possible.

Tip: Consider building a detached garage to completely eliminate the risk of garage pollutants from entering the house.

Considerations:

- Explained in Rationale above.

Resources:

- None

3PR-5_ & 4PR - 5 NOT USED

3PR-6_ & 4PR - 6 If recessed light fixtures are being added or replaced where they penetrate into the unconditioned area of the attic, then they must be installed to prevent air and thermal leakage such that the ceiling performs as if there were no can lights installed

Requirements:

Documenting existing recessed cans:

1. Cans are inspected to see if they are in the insulated envelope (and it is discovered that they are).
2. Cans must be inspected and documented as to whether they are Washington State Energy Code (WSEC) compliant, and if they are Insulation Contact (IC) rated. If not IC rated, then all insulation must remain minimum 3” from can housing.
3. Must do before and after blower door test and infrared scan of recessed cans that are in an insulated ceiling and document the results.
4. Must inspect the cans from the attic side (if possible) and document the results.
5. Can lights may not be installed in slopped calls or vaulted ceilings unless a continuous R-38 can be met on top and sides of the can.

Tip: Points can be obtained, and these requirements can be met, by doing measure 1B-1: Document all existing conditions, equipment and assemblies in house

Installation Steps (for new or replacement applications):

1. Seal can to ceiling finish material with gasket, caulk or foam.
 2. Air sealed with foam box or dome.
 3. Insulate at fixture location to match R-value of surrounding ceiling.
-

[Thank You Sponsors - Together We Improve Homes & People's Lives](#)

Final Documentation Requirements:

1. Post-construction photo of recessed cans taken from top (attic) and bottom (room) view—OR—inspection.
2. Post-construction blower door test results.
3. Post construction Infrared scan results.

Exceptions:

- None

Rationale:

- The use of recessed can lights is a difficult issue from the Green building perspective. If they are located where they penetrate the air and thermal boundary of a building they are typically difficult to properly air seal and insulate, however it can be done. If the careful steps described in this pre-requisite are NOT followed they can contribute to major energy usage and durability problems, which are certainly not Green. Additionally, can lights are inefficient at lighting a room and generally require using a greater number of fixtures, thereby significantly increasing the energy load of the home. Further concerns about the amount of heat generated by the number of bulbs, is another reason to consider eliminating the use of can lights entirely. For this reason, some designers and homeowners choose to avoid them as much as possible.
- On the other hand, for many designers and homeowners, recessed can lights are seen as a necessary component at times to create a beautiful, comprehensive architectural and lighting design.
- A complete ban on can lights would present a significant barrier to entry and limit use of the GreenStar program. Furthermore they can serve to illuminate certain spaces better than other lighting devices.
- Therefore the GreenStar recommendation is that they should be used as infrequent as possible. However, where the designer feels they are necessary, they can be used if proper steps are taken to ensure they will not cause problems with energy efficiency and durability.
- GreenStar STRONGLY encourages those individuals who choose to use recessed lights in their projects to consider using only LED can lights. They are dramatically more efficient, produce the same style of light, do not produce the heat that traditional can lights do, and have a life of around 50,000 light hours (30 years).

Considerations:

- Explained in Rationale above.

Resources:

- See installation diagrams below

[Thank You Sponsors - Together We Improve Homes & People's Lives](#)

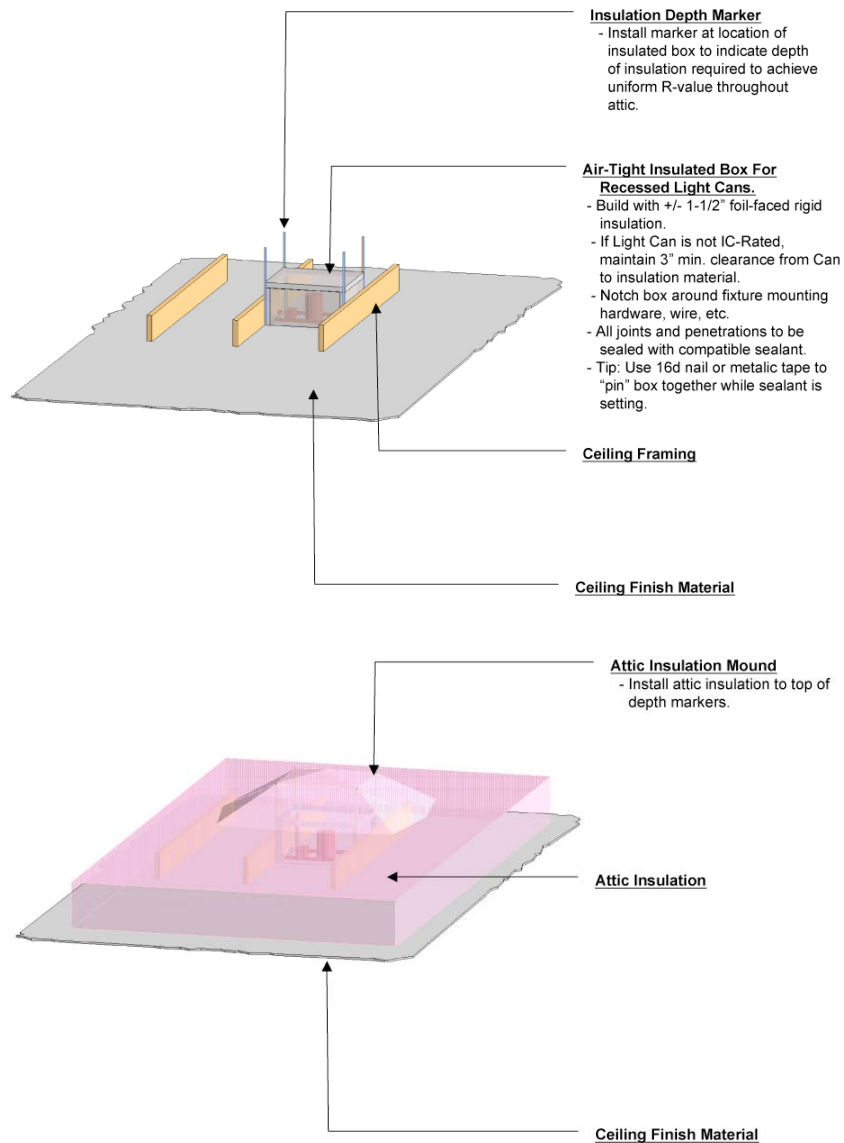

3PR-7_ & 4PR - 7 Any new installation of salvaged doors or windows in an exterior application must be weather stripped, or air sealed with appropriate gasket

Requirements:

1. Notes on drawings and/or specifications indicating work to be done, or product to use.

[Thank You Sponsors - Together We Improve Homes & People's Lives](#)

2. Post-installation photo—OR—rater verification

Exceptions:

- None

Rationale:

- New windows and doors are designed and sold with air tightness measures in place. This prerequisite is designed to ensure that doors or window sashes that are installed into existing frames/openings are not installed without good air-sealing measures in place.

Considerations:

- None

Resources:

- None

3PR-8_ & 4PR-8 All new connecting doors between living space and attached garage are gasketed or made substantially airtight with weather stripping and an automatic closer.

Requirements:

1. Notes on drawings and/or specifications indicating work to be done, or product to use.
2. Post-installation photo—OR—rater verification

Exceptions:

- None

Rationale:

- Garages contain many pollutants that should be kept out of the house. Doors that close automatically and are well sealed help reduce the amount of garage pollutants that migrate into the house.

Considerations:

- None

Resources:

- None

3PR-9_ & 4PR - 9 No power roof vents unless adequate air inlets exist (see 5PR - 6)

[Thank You Sponsors - Together We Improve Homes & People's Lives](#)

- [See 5PR - 6](#)

3PR-10_ & [4PR - 10_](#) Insulation product info. sheet showing R-Value.

Requirements:

- Supply info. Sheet from mfr. of insulation.

Exceptions:

- None

Rationale:

- Proper documentation prevents greenwashing.
- The correct R-value for insulation is very important.

Considerations:

- None

Resources:

- See Rationale above.

3PR-11_ & [4PR - 11_](#) All insulation used must be formaldehyde-free

Requirements:

- All insulation including fiberglass insulation must be formaldehyde-free.

Exceptions:

- None

Rationale:

- Formaldehyde is a known carcinogen and introducing it to the home should be avoided, as should its use and manufacture.

Considerations:

- None

Resources:

- None

3PR-12_ Wall cavities exposed during removal of existing full units must be insulated with foam (no fiberglass allowed for this application)

[Thank You Sponsors - Together We Improve Homes & People's Lives](#)

Requirements:

- Seal the space between the framing for window or door (including attic access door) Rough openings and the installed units with low-expanding spray foam sealant, closed cell foam backer rod, spray applied insulation, or other suitable sealant.
- Cellulose, fiberglass, or rock wool batt insulation is not acceptable as a sealant, but can be used as a backing for a sealant (such as caulk). Thresholds for exterior doors shall be sealed to the subfloor.
- Rater sign off at Pre-drywall inspection.

Exceptions:

- None

Rationale:

- When replacing an entire window unit with a new one, walls are often partially opened, which exposes wall areas that have little or no insulation. Since proper flashing is also required in 4D-PR3, this is a good opportunity to properly insulate these areas as well.
- Fiberglass insulation alone is not a good air barrier and is therefore not an acceptable solution.

Considerations:

- None

Resources:

- TBD

3A - AIR TIGHTNESS

An energy efficient home should be built as tight as possible and ventilated properly. An excellent air barrier is one of the most important elements of a high performance envelope assembly. Working with a home performance specialist is critical to understanding everything that is taking place in the home and developing a successful strategy for success. See also “Air Barriers and Vapor Barriers (Retarders)” in Resources.

Some key concepts and terms associated with the whole issue of air tightness and ventilation in homes include the following.

- Air tightness in homes is measured using a Blower Door Test, and is described in terms such as the number of Air Changes per Hour (ACH) or Cubic Feet per Minute (CFM)
- Chimneys must remain uncovered and dampers shut during the Blower Door Test

[Thank You Sponsors - Together We Improve Homes & People's Lives](#)

- Fireplace openings should remain as they are, most of the time (i.e., if they have glass doors that are normally closed, they should remain closed during the test). Conversely, if the fireplace opening remains open most of the time, it should remain open during the test.
- Reduced air infiltration can directly correlate to reduced energy consumption as well as providing better thermal comfort in the home.
- An infrared test can also be done to help identify weak points in the building envelope.
- The house is usually depressurized to 50 pascals, during the Blower Door Test, which produces an even amount of pressure on all areas of the structure. As air is removed from the home, the rate at which replacement air infiltrates the home is measured.
- ACH-natural is typically easier to grasp and is calculated from the ACH-50 number. It is meant to represent the amount of air that would naturally leak in and out of the home. See the conversion formula and climate correction factor in 3A - 1.
- A quick rule of thumb for the amount of natural air leakage needed for the occupants of the home to be healthy is between 0.30 and 0.35 ACH-natural. If the home does not leak this much, then mechanical ventilation must be installed.

Note: At first glance, it may appear that a leaky home would be preferred, however this could not be farther from the truth. A leaky home is not an acceptable ventilation strategy. Controlled and managed ventilation is the only appropriate strategy for a tight home.

- The major drawbacks of a house that depend on air leaks for ventilation are as follows.
 - o The actual amount of air exchange depends somewhat upon the pressure difference between inside and outside. Therefore, variations in temperature, wind speed, wind direction, and house form cause fluctuations in the amount of fresh air that comes in. On a calm mild day, there will be very little fresh air coming into the home at all, whereas on a cold windy day, there will be too much, and it will almost all be coming in on the windward side of the home.
 - o A house that is leaky enough to have adequate fresh air for the occupants is NOT energy efficient. The Fresh air that is entering the home is being filtered through the home's wall, roof, and floor assemblies, where impurities can be picked up and moisture can be left behind. Avoiding both of these conditions is strongly recommended.
- Chimneys are major contributors to a building's air leakage. Improperly functioning dampers often are a major cause, and should be inspected.

There are a number of strategies that can be employed to reduce air infiltration on existing homes. They include upgrading or replacing windows and doors, insulating window weight pockets after retrofit, and sealing around gaps and cracks. See also Improvements to Windows, Skylights, and Doors.

[Thank You Sponsors - Together We Improve Homes & People's Lives](#)

3A-1_ Air infiltration rate is 0.35 air changes per hour (ACH-natural) or less upon project completion, regardless if changes were made to tightness during project or not (See also OPR - 14 for Fresh Air Supply)

Requirements:

- **Submit Blower Door and FAS calculations from Rater.**
 - GreenStar approved Rater must generate report using TECTITE Software, which is available from the Energy Conservatory.
(www.energyconservatory.com/products/products8.htm)
 - Accurate home floor size and volume must be entered into TECTITE for accurate results.

Exceptions:

- None

Rationale:

- Reducing natural air infiltration is very important to improving energy efficiency, durability, and comfort.

Considerations:

- Inadequate fresh air ventilation can be detrimental to the health of the occupants and the durability of the home itself.

Resources:

- Diagram of Blower Door Testing Equipment

[Thank You Sponsors - Together We Improve Homes & People's Lives](#)

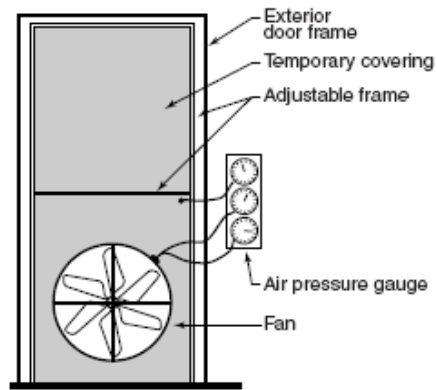

Blower door diagnostics determine building envelope leakage.

[Thank You Sponsors - Together We Improve Homes & People's Lives](#)

Blower Door Test Formula

Thank You Sponsors - Together We Improve Homes & People's Lives



ACH Building Envelope Leakage Test

The housing units must meet minimum criteria for air tightness. The minimum required blower door test result shall be <0.35 ACH Natural with outside ventilation

$$ACH_{\text{natural}} = \frac{ACH_{50}}{N}$$

$N = C \times H \times S$

C = Climate correction factor

H = Height correction factor

S = wind Shielding factor

Equation:

$$ACH_{50} = (CFM_{50} \times 60) / \text{Volume}$$

$$ACH_{\text{natural}} = ACH_{50} / (H \times S \times C)$$

Where:

H = Height correction factor

# Stories	1	1.5	2	2.5	3
H =	1	0.9	0.8	0.75	0.7

S = wind Shielding factor

Extent of Shielding	Shielded	Normal	Exposed
S =	1.2	1	0.9

C = Climate correction factor

(use 21 for Atlanta)

C = 14-17	North Texas panhandle
C = 17-20	Most of Texas
C = 20-23	LA, AR, NC, SC, most of MS and GA
C = 23-25	Northeast MS, LA, south GA

Example:

2,000 sq ft unit with 8 ft. ceiling
Blower door test reveals 1,760 cfm₅₀

S = Normal

H = 1 story

C = 21

So, $ACH_{50} = (1,760 \times 60) / 16,000 \text{ ft}^3$

$$ACH_{50} = 6.6$$

and, $ACH_{\text{natural}} = 6.6 / (1 \times 1 \times 21)$

$$ACH_{\text{natural}} = .31$$

SFBE Building Envelope Leakage Test

The home must meet minimum criteria for air tightness. The standard ASTM test is a blower door test conducted at 50 Pascals. The results of the test for a single-family house must satisfy the following condition:

$$\frac{CFM_{50}}{SFBE} < 0.50$$

Where CFM₅₀ is the volume of air in cubic feet per minute moved through the fan to maintain a 50 Pa pressure difference and SFBE is the square foot of building envelope between conditioned and unconditioned spaces.

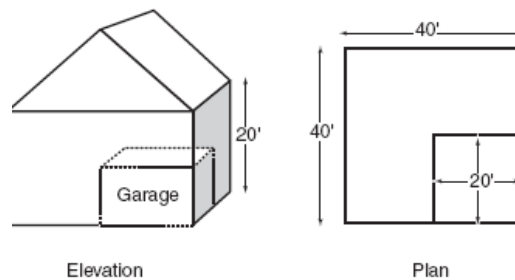

EXAMPLE:

SFBE = Slab + Walls + Room over Garage + Ceiling

$$\text{Slab} = (40 \times 40) - (20 \times 20) = 1600 - 400 = 1200 \text{ ft}^2$$

$$\text{Walls} = 20 \times (160) = 3200 \text{ ft}^2$$

$$\text{Room Over Garage} = (20) \times (20) = 400 \text{ ft}^2$$

$$\text{Ceiling} = (40) \times (40) = 1600 \text{ ft}^2$$

$$\text{SFBE} = 1200 + 3200 + 400 + 1600 = 6400 \text{ ft}^2$$

BLOWER DOOR TEST RESULT:

2000 CFM₅₀ at 50 Pa pressure

CALCULATION:

$$2000 \text{ CFM}_{50} / 6400 \text{ SFBE} = 0.32$$

since $0.32 < 0.40$ testing criteria is fulfilled

[Thank You Sponsors - Together We Improve Homes & People's Lives](#)

[Thank You Sponsors - Together We Improve Homes & People's Lives](#)



3A-2_ Air infiltration is reduced in the house by XX%

Select one:

- 3A-2a_ 20%
- 3A-2b_ 30%
- 3A-2c_ 40%

Requirements:

- Provide results of pre-construction blower door test. (Rater Verified CFM @ 50 pascals)
- Provide results of post-construction blower door test. (Rater Verified CFM @ 50 pascals)
- Remember to address Fresh Air Supply requirements (see also OPR-12)
- Document existing fresh air supply system. Describe type of system (e.g., natural ventilation only, exhaust only, balanced HRV, balanced ERV, etc.) and indicate whether adequate levels are being met using the following two criteria:
 1. Total ventilation rate (CFM) = (0.02 x square feet of conditioned space) + [15 x (number of bedrooms +1)]
 2. Continuous ventilation rate shall be a minimum of 50% of the total ventilation rate, but not less than 40 cfm. Natural ventilation is considered “continuous ventilation” for the purposes of this calculation.Note: If either of these two criteria are NOT met, ventilation must be improved. See Section 5 for strategies and points associated with them.

Exceptions:

- None

Rationale:

- Reducing air infiltration is very important to improving energy efficiency, durability, and comfort.

Considerations:

- None

Resources:

- TBD

3A-3_ Perform infrared thermal imaging during blower door test

Select all that apply:

- 3A-3a_ Before (to identify problem areas)

[Thank You Sponsors - Together We Improve Homes & People's Lives](#)

3A-3b_ After (to document that issues discovered have been amended)

Requirements:

- Perform test.
- Provide documentation of results.

Exceptions:

- None

Rationale:

- Infrared scan performed in conjunction with a blower door test is a very effective method to identify air leaks and insulation gaps.

Considerations:

- None

Resources:

- TBD

3A-4_ HERS Index Score at the end of the project regardless of whether changes were made to improve this score during the project.

Requirements:

- Provide HERS Index report based on actual construction with final documentation

NOTE: It is highly recommended that if you are pursuing this credit that you also do pre-construction energy modeling. This will help inform your design process and will make the post-construction energy modeling easier since details about the existing house will already be entered into the software.

3A-4a	70-74
3A-4b	65-69
3A-4c	60-64
3A-4d	50-59
3A-4e	40-49
3A-4f	30-39
3A-4g	20-29
3A-4h	< 20

[Thank You Sponsors - Together We Improve Homes & People's Lives](#)

Exceptions:

- None

Rationale:

- To have a significant impact on the global ecosystem, HERS scores will need to be much better than 75, but that is the current entry point in the GreenStar program.
- This credit gives a large incentive to improve the energy performance of the home.

Considerations:

- None

Resources:

- Residential Energy Services Network (RESNET), REM/Rate computer software is used by the Rater to calculate the HERS Index Score.

3A-5_ Remodeled Home certified as an ENERGY STAR Home.

Requirements:

-
- Remodeled home shall be certified ENERGY STAR according to the requirements of Department of Energy (DOE) ENERGY STAR program available at [www.ENERGY STAR.gov](http://www.ENERGYSTAR.gov).
- HERS Score of house at the end of the project must be 80 or lower.
- Submit ENERGY STAR documentation that is provided by the RESNET Energy Rater who does inspections and testing throughout the project.

Exceptions:

- None

Rationale:

- Proven standard used to reduce energy consumption.

Considerations:

- Getting ENERGY STAR certification on existing home is possible but may require substantial improvements to achieve a qualifying HERS score of 80 or less.
NOTE: if Rater cannot visually inspect insulation, then they need to be conservative on their assumptions about the quality of the installation of the existing insulation in the house, which lowers the HERS score.

Resources:

- TBD

[Thank You Sponsors - Together We Improve Homes & People's Lives](#)

3B - Improvements to Existing Foundations, Crawl Spaces, and Slab Floor Assemblies

An unconditioned crawl space has no opening to the existing basement and ventilates directly to the exterior. A conditioned crawl space is sealed from exterior air and exchanges air directly with the attached basement space either passively or actively. Before conditioning an unconditioned airspace, verify that mold is not present. A conditioned crawl space is preferred to an unconditioned one, primarily because they are more efficient and resist energy loss. Ductwork and water lines remain within the building envelope, and the room above is more comfortable. Follow EEBA Water Management Guide and EEBA Climate Specific Builder's Guide for crawl spaces.

3B-PR1_ Install radon mitigation system if finishing an unfinished basement

Requirements:

- Perform test after installation of system using qualified test kit. Both a 48-hour test and a 90-day test are acceptable. Levels must be below 4 picocuries.
- Supply homeowner with a copy of the test results.

Exceptions:

- None

Rationale:

- Installing a radon system, regardless of level of picocuries, is critical to the long-term health of the occupants.
- Installing a radon system after a basement is finished is much more costly than installing one prior to finishing the space.

Considerations:

- None

Resources:

- Protecting Your Home From Radon: A Step-By-Step Manual for Radon Reduction, Second Edition
Colorado Vintage Companies, Inc.
525 East Fountain Boulevard, Suite 201
Colorado Springs, CO 80903
Phone: (719) 632-1215 Fax: (719) 632-9607
www.coloradvintage.com

[Thank You Sponsors - Together We Improve Homes & People's Lives](#)

3B-PR2_ Remember basement risk assessment and Calcium Chloride Test before finishing basement (see 3PR-2 for more details)

Requirements:

- See 3PR-2

Exceptions

- See 3PR-2

Rationale:

- See 3PR-2

Considerations:

- See 3PR-2

Resources

- See 3PR-2

3B-1_ Leave minimum 1” gap between wall framing and foundation wall

Requirements:

- Notes on drawings and/or specifications describing work to be done.

Exceptions:

- None

Rationale:

- Depending on the assembly you select for finishing the basement, this gap can serve different purposes
- It may be used as an air gap to allow for air to circulate and help moisture evaporate.
- It may provide a thermal break and moisture break between masonry and framing materials.

Considerations:

- This should be coupled with a holistic approach to addressing bulk water and water vapor in the foundation wall assembly.

Resources:

- TBD

[Thank You Sponsors - Together We Improve Homes & People's Lives](#)

3B-2_ Frame perimeter wall with steel studs

Requirements:

- Notes on drawings and/or specifications describing work to be done and/or materials to use.
- Pre-drywall photo of framing—OR—rater verification

Exceptions:

- None

Rationale:

- If moisture and temperature conditions are ever right for mold growth, steel studs will not supply food source that mold needs like wood does.
- Steel studs typically have 25% of post-consumer recycled steel, and it is nearly infinitely recyclable again when it is removed from the house.

Considerations

- None

Resources:

- TBD

3B-3_ Document the condition of the air sealing, vapor retarder and insulation at rim joist. Improve any areas that do not have proper air seal, vapor retarder and/or minimum R19 insulation as necessary. (Rim joists that do not need improvement also qualify.)

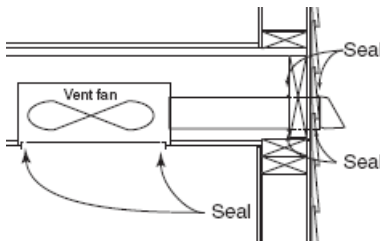

(EC, 7.5)

Requirements:

- Document existing rim joist conditions. (Note: This may already be happening as a part of measure 1B-1, if that was selected.)
- Improve existing conditions if necessary.

[Thank You Sponsors - Together We Improve Homes & People's Lives](#)

- If rim joist area will eventually be covered with finish material, then pre-drywall photo—OR—rater verification
- If rim joist area will be left open, then post-construction photo—OR—rater verification

Exceptions:

- None

Rationale

- Proper air sealing, vapor management and insulation contribute greatly to high energy efficiency, durability, and comfort.

Considerations:

- None

Resources:

- TBD

**3B-4_ Improve existing unconditioned crawl space that will remain unconditioned.
Select all that apply:**

Select all that apply:

Requirements:

3B-4a_ Install:

1. Air and vapor barrier under floor sheathing
2. R-25 Insulation between joists.
3. Continuous R5 rigid insulation under joists.
4. Weather-resistant sheathing as final protection layer (air sealing must include all plumbing electrical, and HVAC penetrations plus any chases)

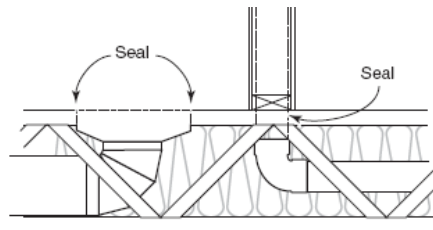

[Thank You Sponsors - Together We Improve Homes & People's Lives](#)

3B-4b_ Openings between conditioned basement or crawl space and unconditioned crawl space are sealed with solid blocking and any remaining gaps are sealed with caulk or foam—OR—no such openings exist

Requirements:

- Photo of sealed openings. Take photo once the openings are sealed, but before they become difficult to see. (i.e. before drywall)
- If no such opening exist, note this in the Comments Column of the checklist.

3B-4c_ Insulate ductwork passing through unconditioned crawl space to R10—OR— no such ductwork exists (see 5C-3f for points)

Requirements:

- Photo of insulated ducts before drywall installation.
- If none exist, note this in the Comments Column of the checklist.

Exceptions:

- None

Rationale:

- Despite the fact that it is considered best practice to condition crawl spaces in our climate, when remodeling older homes it is not always practical or necessary, and it depends on the type of crawl space in question.
- For example, in older homes it is common to encounter porches that have been converted to heated living space, or the owners WOULD LIKE to do this. The crawl space under these porches, often have lattice or minimal walls to keep rodents and pests out. Sometimes something resembling a foundation wall exists, but does not extend down below the frost line. It is typically not practical or necessary to condition these crawl spaces. Rather, a better approach is to seal and insulate and protect the underside of the floor, and let the crawl space be vented to the exterior as much as possible. This credit addresses these situations.

Considerations:

- This strategy is NOT intended for crawl spaces that have full foundation walls (see 3B-5)
- Under no circumstances should a crawl space be left sealed without any ventilation. The combination of moisture from the soil and minimal air exchange can rapidly lead to the deterioration of framing members.

Resources:

- TBD

3B-5_ Condition an unconditioned crawl space

[Thank You Sponsors - Together We Improve Homes & People's Lives](#)

Select all that apply:

3B-5a_ Air seal crawl space walls and insulate to R-10 or better without creating vapor trap.

Note: If foundation cannot dry to exterior above grade through minimum of 16" of exposed foundation and/or rim joist area is not separated from foundation by a capillary break, then insulation and air seal must be vapor permeable. Install thermal barrier to protect insulation as required by code (see also 3PR-2).

3B-5b_ Use spray foam to air seal and insulate crawl space walls.

Note: If foundation cannot dry to exterior above grade through minimum of 16" of exposed foundation and/or rim joist area is not separated from foundation by a capillary break, then closed cell foam insulation CANNOT exceed the thickness that would reduce its vapor permeability to 1 perm or less.

3B-5c_ Install crawl space ventilation system. Crawl space is provided with conditioned supply air at a rate not less than 0.02 cfm per square foot of horizontal area. Appropriately sized exhaust opening to other interior space is required to prevent over 3 pascals of pressurization.

3B-5d_ Install hydronic heat supply to crawl space (e.g., fin tube)

Requirements:

- Seal any openings and passive vents to exterior in crawl space.
- Install Class 2 Vapor Retarder (1 perm or less) on top crawl space floor surface (assumed to be sand, or gravel).
- Allow foundation wall to breathe to interior. Prevents bulk water, water vapor and other soil gasses from entering living space or interior finish systems.
- Provides capillary break and drainage medium for water, water vapor and other gasses
- A minimum 4" deep gravel bed shall be installed beneath all concrete floor slabs. If plastic vapor barrier is installed, plastic must be on top of gravel.
- Air seal all seams including the seam between the vapor barrier and the foundation. Mastic is required for sealing because tape will fail over time.

Rationale for 3B-5a & 3B-5b:

- Conditioning an unconditioned crawl space can improve the energy efficiency, durability and comfort of a house.
- A (concrete) foundation wall that has a VAPOR TRAP is defined here as one that does not have adequate drying potential to either the interior or the exterior for the wall to substantially dry out if it gets wet.
- When insulating a basement foundation wall on the interior, the concern is that:

[Thank You Sponsors - Together We Improve Homes & People's Lives](#)

- IF there is no capillary break that prevents moisture from migrating up into the rim joist area (highly unlikely that any such material exists in a home more than 10 years old),
- IF the rim joist area does not have drying potential (very possible if the rim joist was air sealed and insulated to the interior and/or exterior),
- THEN adding any material to the inside surface of the foundation wall that prevents drying to the interior, could dangerously increase the vapor drive within the foundation wall itself to push moisture up into the rim joist assembly and the wall above it. This could result in mold and durability problems in those assemblies above the foundation.

Since concrete wicks water very well, a capillary break between the top of the foundation wall and the rim joist / floor assembly, that is connected to an interior vapor retarder, would be the ideal material in the whole assembly to ensure moisture does not enter the wood assemblies above the foundation, from the foundation. Unfortunately, it is very difficult to install a capillary break on an existing house without lifting the whole house off of the foundation.

It should not be a problem to prevent crawl space walls from drying to the interior if the foundation has an opportunity to dry to the exterior above grade and/or the rim joist area is separated from the foundation by a Class 1 vapor barrier / capillary break. The reality is that even if a foundation cannot dry to the exterior below ground due to waterproofing or wet soil, moisture should be able to dry to the exterior between the top of the ground and the top of the foundation. This should prevent excessive moisture from migrating up into the wood rim joist area. On the other hand, if the rim joist area is protected by a class 2 (1 perm or less) or class 1 (0.1 perm or less) vapor retarder the rim joist area will also be protected regardless of the ability of the wall to dry to the interior or exterior.

On older homes, it is unlikely that there will be a vapor barrier between the foundation and the rim joist area, but typically there is anywhere from 16” to 24” of exposed foundation between the top of the ground and the bottom of the rim joist, which allows them to dry to the exterior even if drying is not allowed to the interior.

If mold develops between the insulation and the foundation wall, the air and vapor barrier should prevent it from contaminating the indoor environment. Since spray foam eliminates any air space between the insulation and the foundation wall, it is particularly well suited to for this application. On the other hand it may be more difficult to apply a thermal barrier to spray foam without adding wall framing, as compared to foil faced insulation, which typically does not require any additional thermal barrier. Intumescent paint may be an option to protect closed cell spray foam in this situation, however it is usually expensive. Be sure to consult with a building code official for approval before using intumescent paint.

Rationale for 3B-5c:

[Thank You Sponsors - Together We Improve Homes & People's Lives](#)

It is appropriate to ventilate the crawl space intermittently with air from the forced air HVAC system OR by installing a dedicated fan that circulates air between the crawl space and the basement and/or the crawl space and the living space above. Fans are very efficient today and there would NOT be a significant energy penalty to have one running to improve the crawl space air quality.

It would not be advisable to allow crawl space air to mix with the basement or house air UNLESS the crawl space has a slab and/or vapor barrier on the floor along with sealed and insulated walls. A crawl space that is not sealed in this way would be too susceptible to producing mold, which could contaminate the air that the occupants would eventually breathe.

If it is too difficult to seal the crawl space floor and walls adequately to make the crawl space air suitable to mix with house air, an alternative approach is to install a crawl space depressurization system, which incorporates the crawl space ventilation into the exhaust side of the whole house fresh air ventilation system. It can consist of the following:

1. Install passive openings in the floor above the crawl space to allow air to move from the living space into the crawl space.
2. Install continuously running exhaust fan in the crawl space—OR—install continuously running ERV or HRV in the crawl space, which draws air from the crawl space and exhausts to the exterior.

Note: If installing an ERV or HRV, the fresh air supply cannot be allowed to empty into the crawl space.

By drawing air out of the crawl space, the crawl space undergoes continuous air exchange, which will prevent the build up of unhealthy gasses and moisture in the crawl space, yet crawl space air is never allowed to enter the living areas of the house.

Builders Guide To Cold Climates, by Lstiburek, describes this system well.

Considerations:

- Already explained in requirements and Rationale above.

Resources:

- The drawing below shows a number of the different crawl space insulation best practices.

[Thank You Sponsors - Together We Improve Homes & People's Lives](#)

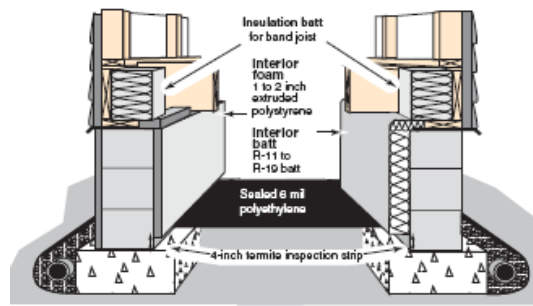

Insulate crawl space walls

3B-6_ Improvement to foundation wall insulation and air sealing (bulk water and water vapor must be addressed)

Select all that apply:

3B-6a_ Air seal basement walls and insulate concrete walls to R-10 or better and framed walls to R-13 or better. If concrete wall is insulated, framed wall to inside of it can be without insulation.

3B-6b_ Use spray foam to air seal and insulate basement walls

Requirements:

Document conditions of existing foundation.

Note: This may already be happening as a result of measure 1B-1, if it was selected.)

1. Existing bulk water control system
 2. Existing water vapor control system
 3. Existing drying potential
 4. Existing Insulation
 5. Existing air barrier
 6. Condition of studs, finish material, trim or any other part of an assembly that may be pre-existing.
- If mold, moisture, or decay is discovered, determine cause if possible and eliminate it. Remove the damaged material and dispose of properly. Re-frame the section adding a capillary break and hold the studs a minimum 1” from the basement wall.
 - If no framing exists follow steps for basement finishing that is explained in 3PR-2.
 - Provide notes on plan and/or specifications indicating materials to be used and work to be done.
 - Perform construction work.
 - Pre-drywall photo—OR—rater verification

[Thank You Sponsors - Together We Improve Homes & People's Lives](#)

Exceptions:

- None

Rationale:

- Making improvements to existing foundation walls can improve the energy efficiency, durability and comfort of a house.
- Many foundation walls in existing homes are not insulated on either the exterior or the interior. Obviously, adding a proper air seal and insulation system would help boost energy efficiency.
- Many other foundation walls in existing homes have been air sealed and insulated in a poor way, and this credit gives incentive to improve them as well.
- See also Rationale for 3B-5a & 5b above for notes about drying.

Considerations:

- Extreme caution must be taken when making improvements to foundation walls.

Resources:

- TBD - Provide drawings of recommended assemblies.

3B-7_ No carpet installed in basement

Requirements:

- Provide notes on plan and/or specifications indicating materials to be used and work to be done.
- Perform construction work.
- Post-construction photo—OR—rater verification

Exceptions:

- None

Rationale:

- It can be safe to install carpet on a limited number of basement floor assemblies, but as a rule of thumb, it is better to just avoid it all together. This credit gives incentive to choose a different floor material other than carpet.

Considerations:

- Carpet can hold moisture, dust, allergens, and mold. Carpet is not a durable or long lasting material.

Resources:

- TBD

[Thank You Sponsors - Together We Improve Homes & People's Lives](#)

3B-8_ Install or improve bulk water drain system

Select all that apply:

- 3B-8a_** Install exterior system such as waterproofing, drain board or sheeting, insulation, perimeter drain tile (or similar), etc.
- 3B-8b_** Install interior sub-slab perimeter drain tile system with sealed sump basket and integrated dimpled drainage sheeting at bottom of wall and floor slab edge. Air seal all edges and seams.
- 3B-8c_** Install interior dimpled drainage sheeting to top of exterior grade minimum Air seal all edges and seams.
- 3B-8d_** Integrate soil gas (a.k.a. radon) vent pipe with interior sub-slab drain tile
- 3B-8e_** Install rigid insulation at slab edge and under slab where interior sub-slab drain tile was installed.

Requirements:

- Document conditions of existing bulk water drain system for foundation.
- (Note: This may already be happening as a result of measure 1B-1, if it was selected.)
- Provide notes on plan and/or specifications indicating materials to be used and work to be done.
- Perform construction work.
- Post-construction photo—OR—rater verification

Exceptions:

- None

Rationale:

- 3B-8a - 3B-8c. The need for proper bulk water management cannot be emphasized enough.
- Regardless of what bulk water management system is installed on the exterior (usually none on older homes) installing one on the interior is a safe approach.
- 3B-8d. Attaching the soil gas (a.k.a. radon) vent pipe to the sub-slab drain tile improves its effectiveness in removing radon and moisture.
- 3B-8e. Concrete floor slabs lose a higher proportion of heat through their edges. When the slab edge is opened up to install a drain tile, it is also a great opportunity to install insulation at this part of the slab.

Considerations:

- Major damage can occur if bulk water leaks into a basement.

Resources:

- TBD

[Thank You Sponsors - Together We Improve Homes & People's Lives](#)

3B-9_ Air barrier spans cantilever and any exposed edges of insulation of any cantilevered floor

Requirements:

- Document conditions of existing air barrier and insulation at cantilever location.
- (Note: This may already be happening as a result of measure 1B-1, if it was selected.)
- Provide notes on plan and/or specifications indicating materials to be used and work to be done.
- For floors with conditioned area over unconditioned open areas, air seal the floor joist cavity with sheet material or blocking and sealant above the top plate of the supporting wall and insulate to a minimum of R38, either with batt insulation between floor joists or with a combination of joist insulation and insulated sheathing on underside of floor joist.
- Perform construction work.
- Post-construction photo—OR—rater verification

Exceptions:

- None

Rationale:

- Where cantilevering floor joist pass over the bearing wall below, they often do not have proper air sealing and insulation in the joist cavities.

Considerations:

- None

Resources:

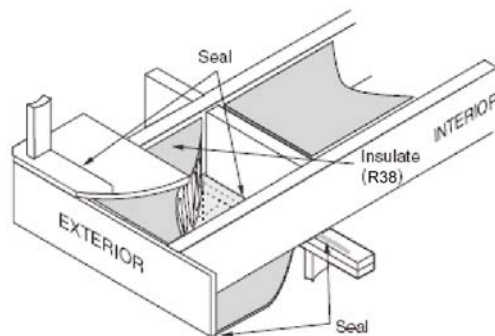

Air seal and insulate cantilevered floors.

[Thank You Sponsors - Together We Improve Homes & People's Lives](#)

3B-10_ Use reclaimed materials on foundation improvements (e.g., brick for exterior of foundation and block for foundation), minimum 50% of all material used

Requirements:

- Provide notes on plan and/or specifications indicating materials to be used and work to be done.
- Perform construction work.
- Post-construction photo—OR—rater verification

Exceptions:

- None

Rationale:

- Reusing existing materials is a very material efficient approach to home construction and remodeling.

Considerations:

- Care must be taken to ensure that reclaimed materials are still structurally sound.

Resources:

- TBD

3B-11_ Full replacement of existing slab

Requirements:

- Make note in Comment Column of Checklist.
- (See Section 4 for new slab credits & Section 9 for demolition credits).

3C - Improvements To All Existing Above Grade Walls, Ceilings and Non-Slab (framed) Floors

Adding insulation to existing walls must be closely examined, as the breath-ability of the wall dramatically changes. Review insulation manufacturer's specifications and air sealing techniques, as well as the particulars of the exterior cladding materials, prior to the installation of insulation. Be careful not to create a double vapor barrier condition as a result of added insulation or building wraps.

[Thank You Sponsors - Together We Improve Homes & People's Lives](#)

3C-PR1_ If existing common wall between an attached garage and the home does not have finish material on it, finish material must be added and properly sealed at perimeter & penetrations.

Requirements:

- Provide notes on plan or specifications stating work to be done.
- Perform air sealing work.
- Pre-wall finish photo
- Points are also available for this in Credit 3PR - 7.

Exceptions:

- None

Rationale:

- If a common wall between the garage and home was not previously sealed or covered the space is not code compliant, and must be brought up to minimum standards. For the project to be considered Green, additional measures (air sealing) must be taken.

Considerations:

- None

Resources:

- TBD

3C-1_ Common walls and ceiling between an attached garage and living space are completely air sealed before insulation is installed. Existing detached garage qualifies.

Requirements:

- Provide notes on plan or specifications stating work to be done.
- Seal all penetrations through drywall in attached garage. Block and seal band area between joists above interior garage partition walls.
- Post-construction photo—OR—rater verification

Exceptions:

- None

Rationale

- Air sealing is an effective way to keeping pollutants from entering the house from the garage.

Considerations:

[Thank You Sponsors - Together We Improve Homes & People's Lives](#)

- None

Resources:

- TBD

3C-2_ Add insulation to closed wall cavities that have less than 1-1/2” of insulation (minimum of 50% of uninsulated walls must be insulated to R-11 or better). Gasket and caulk joints. Blower Door Test with infrared scan to check for voids.

Requirements:

Document existing conditions.

(Note: This may already be happening as a result of measure 1B-1, if it was selected.)

- Provide notes on plan and/or specifications indicating materials to be used and work to be done.
- Perform construction work.
- Results from post-construction Blower Door Test and infrared scan.

Exceptions:

- None

Rationale:

- Good wall insulation improves energy efficiency, durability and comfort.

Considerations:

- None

Resources:

- TBD

3C-3_ Use foam to insulate uninsulated wall cavities where wall framing is not exposed (minimum of 50% of uninsulated walls must be insulated to R-11 or better). Infrared scan to check of voids.

- Add poured foam to walls where framing is not exposed.

Requirements:

Document existing conditions.

(Note: This may already be happening as a result of measure 1B-1, if it was selected.)

- Provide notes on plan and/or specifications indicating materials to be used and work to be done.
 - Perform construction work.
 - Results from post-construction Blower Door Test and infrared scan.
-

[Thank You Sponsors - Together We Improve Homes & People's Lives](#)

Exceptions:

- None

Rationale:

- Good wall insulation improves energy efficiency, durability and comfort.

Considerations:

- None

Resources:

- TBD

3C-4_ Air seal and insulate all wall cavities where wall framing is exposed (2x4 walls = minimum R13) (2x6 walls = minimum R19)

Requirements:

- Provide notes on plan and/or specifications indicating materials to be used and work to be done. Must include plate penetrations, sheathing seams and penetrations, and the gap between sheathing and plate (include condensation lines, electrical outlets and locations with broken or missing sheathing using sheathing and a proper sealant).
- Pre-drywall photo—OR—rater verification

Exceptions:

- None

Rationale

- Good wall insulation improves energy efficiency, durability and comfort.

Considerations:

- None

Resources

- TBD

3C-5_ Expose, air seal (including top and bottom plate), and insulate walls adjacent to shower/tub

Requirements:

- Provide notes on plan and/or specifications indicating materials to be used and work to be done.

[Thank You Sponsors - Together We Improve Homes & People's Lives](#)

- Perform this measure when remodeling an existing bathroom, or installing a new bathroom in a room not previously used as a bathroom.
- Air seal all holes in the floor assembly for plumbing wiring, ductwork and other purposes connecting conditioned and unconditioned (and exterior) areas.
- Insulate cold water pipes to moisture condensation. Avoid locating plumbing in exterior walls.
- Insulate all water pipes in climates and building conditions susceptible to freezing temperatures and Conditions. Avoid locating plumbing in exterior walls.
- Air seal penetrations for flues and other heat-producing items with noncombustible sheet materials and high temperature sealant.
- See Section 7, Water - Plumbing, Systems and Fixtures for additional plumbing pipe insulation requirements.
- Pre-drywall photo—OR—rater verification

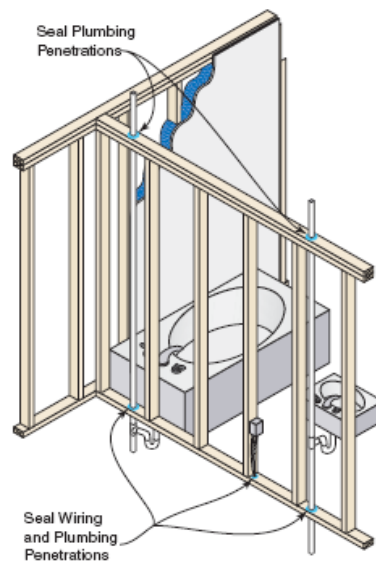

Exceptions:

- None

Rationale:

- Around tubs and showers, it is common to see gaps in insulation and air barriers.

Considerations:

[Thank You Sponsors - Together We Improve Homes & People's Lives](#)

- None

Resources:

- TBD

3C-6_ Penetrations through insulated ceilings are sealed

- All penetrations through insulated ceilings shall be sealed with a proper sealant including HVAC boots, bathroom fans, light fixtures, security, and audio speakers.

Requirements:

- Provide notes on plan and/or specifications indicating materials to be used and work to be done.
- Post-construction photo—OR—rater verification

Exceptions:

- None

Rationale:

- These penetrations are also commonly known as Attic By-Passes.

Considerations:

- None

Resources:

- TBD

3C-7_ Improve existing walls between house & attached garage by sealing all seams, edges, & penetrations of the wall finish material from the garage side

Requirements:

- All edges and joints of the wall finish material must be sealed to obtain this credit. Thus if a ceiling exists in garage, sealant must be applied to the joint on the top-side of the ceiling finish material where it meets the wall top plate.
- Seal all penetrations (such as plumbing or electrical lines) in the connecting wall between an attached garage and house with caulk, spray foam, gasket or construction adhesive to prevent air movement.
- Walls with existing finish material on them can qualify without removing the finish material if photo documentation is provided to show that existing sealing is well done or to show newly added sealant.

[Thank You Sponsors - Together We Improve Homes & People's Lives](#)

- Walls that currently do not have finish material on them must have new finish material added AND that finish material must be sealed at the perimeter, penetrations, etc.
- Post-construction photo

Exceptions:

- None

Rationale:

- Very important to keep garage pollutants out of the house.

Considerations:

- None

Resources:

- TBD

3C-8_ Air seal and insulate floor above garage, ensuring there are no exposed edges

Requirements:

- Provide notes on plan and/or specifications indicating materials to be used and work to be done.
- Pre-drywall photo—OR—rater verification

Rationale:

- Very important to keep garage pollutants out of the house.

Considerations:

- None

Resources:

- TBD

3C-9_ Air seal penetrations and joints in fireplace framing

Requirements:

- Identify and document existing air leaks with pre-construction blower door test with infrared scan (Note: This may already be happening as a result of measure 1B-1, if it was selected.)
- Perform air sealing work.
- Post-construction Photo—OR—rater verification

[Thank You Sponsors - Together We Improve Homes & People's Lives](#)

Exceptions:

- None

Rationale:

- Gaps are common in the insulation and air seal at areas built-out for fireplaces.

Considerations:

- None

Resources:

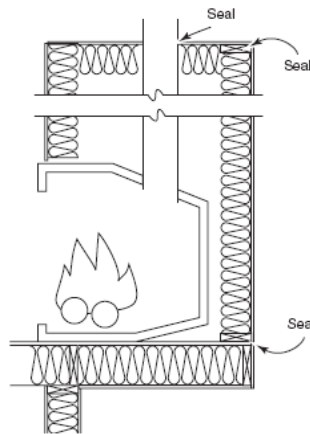

3C-10_ NOT USED

3C-11_ & 4C-11_ Advanced siding materials and techniques used.

Select all that apply:

3C-11a_ & 4C-11a_

Install continuous drainage plane, fully sealed at all penetrations, that directs water away from home. This is a very important to preventing water from entering walls from exterior. When water gets into walls from the exterior, it almost always gets in at penetrations such as windows, doors, and pipes. Special care is required to maintain a continuous well-sealed drainage plane at these areas.

General air sealing and Drainage Plane guide.

[Thank You Sponsors - Together We Improve Homes & People's Lives](#)

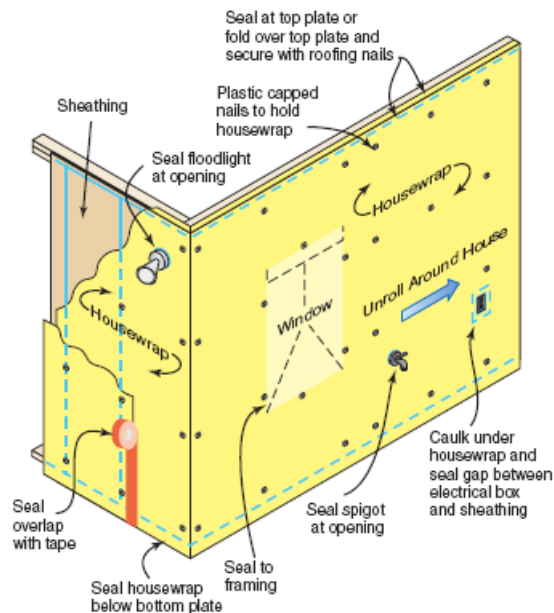

Requirements:

- Install continuous drainage plane fully sealed at all penetrations that directs water away from home.
- No cedar or similar siding in direct contact with fiberglass-type drainage plane. Install vertical “sleepers” or use drainage plane appropriate for wood siding.
- Notes on drawings and/or specifications indicating work to be done or product to use.
- Post-installation photo—OR—rater verification

Exceptions:

- None

Rationale:

- **3C-11b_ & 4C-11b_** Remove siding on existing walls & re-install or replace with Vented Rain Screen System

Requirements:

- For a minimum of 80% of exterior wall area, apply rain screen between sealed drainage plane and exterior cladding to allow water and moisture

[Thank You Sponsors - Together We Improve Homes & People's Lives](#)

to escape, and have an air space between the exterior cladding and wall sheathing.

- Integrate the system with flashing. Also design and install to minimize moisture migration between the exterior cladding and the wall sheathing.
- Rain screen requires air vent at bottom and top.
- Pre-siding photo—OR—rater verification

Exceptions:

- This system should NOT be used with stucco siding.

Rationale:

- A vented rain screen behind the siding helps improve the durability of the siding and the rest of the wall assembly.
- A vented rain screen is a very effective way to prevent bulk water from entering the wall assembly from the exterior, and it improves the wall's ability to dry to the exterior, when and if it does get wet somehow.
- Stucco cannot be installed with the rain screen space behind it, as the stucco will just fill that space up during installation and water can drain through the stucco.
- However, stucco is a very durable siding material. If it is installed properly with a drainage plane system, as it should be, it is effectively very similar to the vented rain screen, and therefore also qualifies for this credit.

Considerations:

- Mixed cladding systems require that there be both flashing and venting at the transition if the lower system is stucco
- Air vents are critical to the proper performance of this system. Subcontractor education and homeowner education to ensure that the vents are not filled is very important.
- Screens must be installed at all vent locations to reduce the opportunity for pest infiltration.

Resources:

- TBD - Add drawing(s) of typical vented rain screen system.
- **3C-11c_ & 4C-11c_.** Back-priming siding on all sides helps increase the life of the siding. It also helps prevent moisture from entering the siding material and causing finishes to blister off prematurely.
 - If manufacturer of siding or trim specifically prohibits back priming, then it should not be done.
- **3C-11d_ & 4C-11d_** Fiber-cement and wood composite siding use our wood resources more efficiently than solid sawn wood siding.

[Thank You Sponsors - Together We Improve Homes & People's Lives](#)

- **3C-11e_ & 4C-11e_** Steel siding is recyclable, very durable, and can be cool if the finish is ENERGY STAR. Also helps minimize wood usage.
- **3C-11f_ & 4C-11f_** Exposed wood or other absorptive material is kept at least 12 inches from soil.

Requirements:

- Maintain 12” minimum space from bottom of wood or other absorptive material to grade.
- Document with photos of all sides of the house. Recommend showing 12” ruler in photo.

Rationale:

- Keeping exposed wood and other materials that readily absorb water away from soil improves their durability its finishes. Reduces need for maintenance.
- **3C-11g_ & 4C-11g_** Brick is a very durable product, and using reclaimed brick is great for the environment.
- **3C-11h_ & 4C-11h_** Install traditional three-coat stucco

Requirements:

- Photo of lathe, photo of brown coat, photo of finished exterior

Exceptions:

- None

Rationale:

- Stucco has been used as a exterior cladding material in Minnesota for over 90 years and has proven its durability and climate appropriateness.

Considerations:

- Acrylic stucco does not qualify for this credit due to concerns about its performance and impact on the home as a system

Considerations:

- None

Resources:

- TBD

3C-12_ Provide flashing at the bottom of all wall cladding, includes weeps and weep screed for masonry veneer, stucco, thin stone veneer, etc.

Requirements:

Document existing conditions.

(Note: This may already be happening as a result of measure 1B-1, if it was selected.)

[Thank You Sponsors - Together We Improve Homes & People's Lives](#)



- Provide notes on plan and/or specifications indicating materials to be used and work to be done.
- Post-construction photo—OR—rater verification

Exceptions:

- If wall cladding is outside of exterior plane of foundation, and projects down minimum 1” from the top of the foundation, then project qualifies for this credit without flashing.

Rationale:

- Flashing at the bottom of the wall cladding helps to prevent water from creeping into the wall assembly at that location.

Considerations:

- None

Resources

- TBD

3C-13_ Wood trim or other water sensitive materials (composites) are kept at least 12” from soil

Requirements:

Document existing conditions.

(Note: This may already be happening as a result of measure 1B-1, if it was selected.)

- Provide notes on Plan and/or specifications indicating materials to be used and work to be done.
- Post-construction photo—OR—rater verification

Exceptions:

- None

Rationale:

- Keeping these materials away from the soil helps increase durability by allowing them to stay drier and to make it more difficult for insects and rodents to enter the building.

Considerations:

- None

Resources:

- TBD

[Thank You Sponsors - Together We Improve Homes & People's Lives](#)

3C-14_ Provide rodent and corrosion proof screens (e.g., copper or stainless steel mesh, aluminum mesh, etc.) for all openings that cannot be fully sealed and caulked (e.g., vents)

Requirements:

Document existing conditions.

(Note: This may already be happening as a result of measure 1B-1, if it was selected.)

- Provide notes on plan and/or specifications indicating materials to be used and work to be done.
- Post-construction photo—OR—rater verification

Exceptions:

- None

Rationale:

- Certain openings on the exterior must remain to allow proper venting of wall assemblies, roof assemblies, mechanical systems, etc. Protecting these with screens is necessary to keep insects and rodents from compromising how these systems work.

Considerations:

- Special care must be taken to ensure that enough airflow still remains even with the screen in place.
- While screens are very important, they do actually reduce airflow a certain amount depending on their size and density.
- Be sure to comply with manufacturer instructions for mechanical equipment vents.

Resources:

- TBD

3C-15_ Replace damaged exterior cladding (minimum 3 sides) with cladding with minimum 40-year warranty.

Requirements:

Document existing conditions.

(Note: This may already be happening as a result of measure 1B-1, if it was selected.)

- Provide notes on Plan and/or specifications indicating materials to be used and work to be done.
- A minimum of three sides of exterior wall cladding shall have a 40-year manufacturer's warranty or be a durable natural material such as masonry stucco, stone, brick or most fiber cement siding.
- Warranty documentation must be provided to the homebuyer.

[Thank You Sponsors - Together We Improve Homes & People's Lives](#)

- Cultured stone does not qualify.
- Post-construction photo—OR—rater verification

Exceptions:

- None

Rationale:

- If existing exterior cladding is in poor condition, it is best to replace it with a material that is very durable. The material warranty is a good indication of the durability of it, and longer warranties are encouraged.

Considerations:

- None

Resources:

- TBD

3C-16_ Existing cavity insulation between studs in exterior walls is GREATER than R19, or it is brought up to this level

Requirements:

Document existing conditions.

(Note: This may already be happening as a result of measure 1B-1, if it was selected.)

- Provide notes on plan and/or specifications indicating materials to be used and work to be done.
- Pre-drywall photo—OR—rater verification

Exceptions:

- None

Rationale:

- Having more than R19 in wall cavities improves energy efficiency, and comfort.

Considerations:

- None

Resources:

- TBD

3C-17_ Advanced insulation materials and strategies

[Thank You Sponsors - Together We Improve Homes & People's Lives](#)

Select all that apply:

- 3C-17a_ Insulation with min 20% recycled content is used for at least 50% of applications
- 3C-17b_ All-natural insulation such as cotton batt, is used for at least 50% of application
- 3C-17c_ Spray foam insulation applied in stud cavities
- 3C-17d_ Spray applied wet cellulose insulation (proper drying required before installing wall finish and/or vapor barrier)

Requirements:

- Recycled content must be certified by Scientific Certification Systems (SCS) or the manufacturer. SCS is on the web at www.scs1.com.
- Provide manufacturer documentation regarding the specifications, recycled content, etc., of the insulation being installed.
- Provide FTC Fact Sheet for insulation material. See also 3PR-11.
- Pre-drywall photo—OR—rater verification

Exceptions:

- None

Rationale for 3C-17a:

- Products that utilize reused, reclaimed or recycled raw materials instead of virgin raw materials are better for the environment and encouraged.

Rationale for 3C-17b:

- Products that utilize natural materials and are from a renewable plant source are better for the environment and encouraged.

Rationale for 3C-17c:

- Spray foam insulation applied in stud cavities provides an excellent air barrier, which boosts energy efficiency and durability. It also improves indoor environmental quality compared to other insulation types.

Rationale for 3C-17d:

- Spray applied wet cellulose has similar benefits as spray foam insulation because it also creates an excellent air barrier. However, the fact that it introduces moisture into the wall assembly, it must be used with extreme caution in Minnesota.
- It should not be installed when the outside weather conditions are too cold to prevent adequate drying. Therefore, it can only realistically be installed in the summer months, but it must be allowed to completely dry before other parts of the wall assembly that could inhibit drying can be applied. Some wall finishes might also be damaged if they are installed over wet cellulose.

[Thank You Sponsors - Together We Improve Homes & People's Lives](#)

- Due to this durability risk associated with applying wet cellulose insulation, a negative point is awarded to wet cellulose in the Resource Efficiency/Durability category.

Considerations:

- None

Resources

- TBD

3C-18_ Install fiberglass-faced (paperless) gypsum board

Requirements:

- Notes on plans or specifications indicating material to be used and/or work to be done.
- Manufacturer documentation of product specifications.
- Pre-painting (or other surface coating)—OR—rater verification.

Exceptions:

- None

Rationale:

- Fiberglass-faced gypsum board does not support mold growth like paper-faced gypsum board does.
- The paper that is used on most gypsum board is an excellent food source for mold when moisture and temperature Conditions are right. Eliminating that food source is one way to reduce the risk of mold growth in the home.

Considerations:

- Users should become familiar with fiberglass-faced gypsum board and use personal safety protecting when working with it.
- The texture is different from paper-faced gypsum board, which makes the finishing process different. Also, when cutting and installing small pieces of the coating can become airborne. This can irritate the eyes, skin and respiratory system if personal safety protection is not used.

Resources:

- TBD

3C-19_ Install Magnesium Oxide board (a.k.a. MgO Board)

[Thank You Sponsors - Together We Improve Homes & People's Lives](#)

Requirements:

- Notes on plans or specifications indicating material to be used and/or work to be done.
- Manufacturer documentation of product specifications.
- Photo before painting or other surface coating is applied

Exceptions:

- None

Rationale:

- Magnesium is a mold inhibitor, and therefore magnesium board does not support mold growth like traditional paper-faced gypsum does.
- MgO is a type of sheathing board-sort of like drywall or cement board-but with much-improved characteristics such as fire resistance, weather-ability, strength, resistance to mold and mildew
- The surface is smooth so traditional finishing methods are mostly the same.
- Concerns about delamination or small fibers becoming air borne do not exist as they do with some other fiber-cement and fiberglass gypsum products respectively.
- When and if MgO board is mined and produced locally, it may qualify for Resource Efficiency points.

Considerations:

- Currently most MgO board is manufactured in Asia and is imported to the U.S.

Resources:

- TBD

3C-20_ Gypsum wallboard with recycled-content gypsum

Requirements:

- Notes on plans or specifications indicating material to be used and/or work to be done.
- Manufacturer documentation of product specifications.
- Photo before painting or other surface coating is applied—OR—rater verification

Exceptions:

- None

Rationale:

- The gypsum that is commonly used in the production of gypsum wallboard (GWB or sheetrock) is a naturally occurring mineral. Synthetic gypsum is a by-product of power

[Thank You Sponsors - Together We Improve Homes & People's Lives](#)

plants that burn coal. It is more Green to use synthetic gypsum to manufacture GWB than to extract virgin natural gypsum for this purpose.

Considerations:

- None

Resources:

- TBD

3C-21_ Gypsum wallboard (GWB) is held a minimum 1/2” from concrete slabs (applies to existing GWB or newly installed GWB)

Requirements:

- Notes on plans or specifications indicating material to be used and/or work to be done.
- Pre-base board installation photo—OR—rater verification
- The absence of GWB or smaller material in this condition does not allow access to this credit.

Exceptions:

- None

Rationale:

- Preventing GWB from being in contact with concrete, helps eliminate any chance that it will wick up moisture from the concrete.

Considerations:

- None

Resources:

- TBD

3C-22_ Seal all gypsum wallboard penetrations in exterior walls using caulk, gaskets or appropriate connection with gypsum board

Requirements:

- Notes on plans or specifications indicating material to be used and/or work to be done.
- Post-sealing photo—OR—rater verification

Exceptions:

[Thank You Sponsors - Together We Improve Homes & People's Lives](#)

- None

Rationale:

- Air sealing is very important to improving energy efficiency, durability, and comfort.

Considerations:

- TBD

Resources:

- TBD

3C-23_ Seal top plate to drywall with gasket, adhesive, or caulk

- Seal drywall to top plate on ceilings separating attic from conditioned space.

Requirements:

- Notes on plans or specifications indicating material to be used and/or work to be done.
- Mid-Installation photo—OR—rater verification

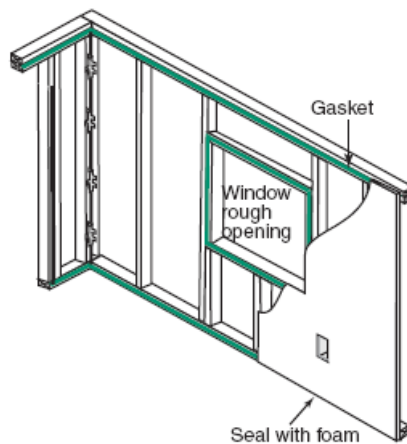

Exceptions:

- TBD

Rationale:

- Air sealing is very important to improving energy efficiency, durability, and comfort.

Considerations:

[Thank You Sponsors - Together We Improve Homes & People's Lives](#)

- none

Resources:

- TBD

3D - Improvements To Existing Windows, Skylights and Doors

Improvements to windows, skylights, and doors enhance the energy efficiency of existing units using simple strategies without replacing the entire unit. Making improvements to windows, skylights, and doors requires keeping the integrity of the frame and sill of the unit in tact. For example, this section applies to situations where only the sash is being replaced and upgraded. This section also applies to situations where a self-contained insert unit is being used to replace the existing sash, provided that it preserves the frame and sill of the existing windows. Full replacement of these units (rough opening) is covered in Section 4D - New Windows, Skylights, and Doors. It is recommended when exterior siding is being replaced on part, or all, of the home that the windows and doors in this situation are replaced with new windows and doors. This also allows for the opening to be properly flashed and protected, and for exterior air sealing to occur. Full replacement windows help the home perform significantly better than with insert windows.

ENERGY STAR and National Fenestration Rating Council are excellent resources for finding windows, skylights, and doors that are energy efficient and rated by a third party. Most existing windows, door, and skylights either do not meet current energy code, or their values are unknown. It is important to evaluate the windows both in the project zone and throughout the entire home to determine if it is best to improve the existing units or if full replacement is more appropriate. This is especially important for smaller projects, as they will most likely be required to look throughout the home to achieve credits to meet the minimum points for this section.

Different window and door materials have different energy efficiency ratings, as well as different embodied energy values. Some windows and doors are being chosen either because they match existing windows, offer better energy ratings, or they represent lower long-term maintenance.

In Minnesota, the reasons to install new windows typically include improved energy efficiency, improved durability, reduced maintenance and improved comfort. However, contrary to what many people assume, it is unlikely that the cost of new windows will pay for themselves over the life of the window.

The main approaches to improving existing windows include:

1. Replacing the existing window with a new full frame insert.

[Thank You Sponsors - Together We Improve Homes & People's Lives](#)

Pros:

- Can significantly improve energy efficiency through air sealing, better insulating glass, and opportunity to install high performance (triple paned) windows.
- Can significantly improve indoor comfort levels because of air sealing and increased U-factor.
- Can reduce maintenance costs over time, if low maintenance surfaces are chosen.

Cons:

- Typically very expensive.
- Much higher amount of embodied energy than keeping existing windows.
- Window will typically NOT pay for itself with the money saved in energy efficiency.
- Hard to match the period of the home
- Not possible on modern (1970+) windows, requires a parting stop.
- Only for double hung windows

2. Keep existing frame, but improve it with air sealing and insulation. Then replace the sash with one containing insulating glass.

Pros:

- Can significantly improve energy efficiency because of air sealing.
- Can significantly improve indoor comfort levels because of air sealing and increased U-factor.
- Can reduce maintenance costs over time, if low maintenance surfaces are chosen for sash.

Cons:

- Moderately expensive to buy new sash and for labor to air seal existing frame.
- Much higher amount of embodied energy than keeping existing windows.
- Window will typically NOT pay for itself with the money saved in energy efficiency.
- Typically a less authentic appearance
- Existing frame may still be leaky
- Requires the use of vinyl compression track, which is not airtight, and does not match the period of the house.

3. Keep existing frame, but improve it with air sealing and insulation. Keep existing sash as well, and accept the fact that it will not be quite as energy efficient or comfortable to be near it.

Pros:

- Can significantly improve energy efficiency because of air sealing.
- Savings in energy efficiency will likely pay for the cost of the improvements.

[Thank You Sponsors - Together We Improve Homes & People's Lives](#)

- Can significantly improve indoor comfort levels because of air sealing, but not to the same comfort level of a new window.
- Least expensive option.
- Most resource efficient option. Preserves existing materials and avoids using a lot of embodied energy to make new windows.
- Most authentic in appearance

Cons:

- Not as comfortable as new windows
- More likely to attract condensation when the weather is very cold or when indoor humidity levels rise to levels that are more comfortable to people.
- More maintenance costs than low-maintenance new window components.
- Existing frame may still be leaky
- Requires the use of vinyl compression track, which is not airtight, and does not match the period of the house.
- Least effective at reducing energy savings

Prerequisites for Section 3D:

3D-PR1_ Replacement sash and units must meet energy code, be ENERGY STAR rated and be NFRC rated (exceptions for existing window sashes and historical projects - see manual)

Requirements:

- Provide manufacturer documentation showing that the units meet the minimum standards of the energy code and ENERGY STAR rating.

		World's Best Window Co. Millennium 2000- Case Wood Frame Double Glazing • Argon Fill • LowE Product Type: Vertical Slider	
ENERGY PERFORMANCE RATINGS			
U-Factor (U.S./I-P)		Solar Heat Gain Coefficient	
0.35		0.32	
ADDITIONAL PERFORMANCE RATINGS			
Visible Transmittance		Air Leakage (U.S./I-P)	
0.51		0.2	
Condensation Resistance		_____	
51			
<small>Manufacturer stipulates that these ratings conform to applicable NFRC procedures for determining whole product energy performance. NFRC ratings are determined for a fixed set of environmental conditions and specific product sizes. www.nfrc.org</small>			



www.energystar.gov

Exceptions:

- Existing windows that are not being replaced are exempt.
- Other exceptions may be made in special circumstances where changes to the home are controlled by the Historical Preservation Committee. Provide documentation to GreenStar to describe the circumstance to obtain GreenStar approval.

[Thank You Sponsors - Together We Improve Homes & People's Lives](#)



Rationale:

- Even though the NFRC rating is already required by the Minnesota State Energy Code, this is often overlooked, and worth mentioning here.

Considerations:

- None

Resources:

- Existing Minnesota Residential Energy Code: See Minnesota Rules Chapter 7672 (www.state.mn.us/portal/mn/jsp/content.do?subchannel=-536881494&programid=536894293&sc3=null&sc2=-536882175&id=-536881350&agency=Commerce)

3D-PR2_ Remove weight(s) and fill weight cavity with foam insulation, when old double hung sash are replaced (no fiberglass insulation allowed for this application)

Requirements:

- Provide notes on plan or specifications stating addition of insulation and type
- Requires the removal of interior window trim.
- Seal the space between the framing for window or door rough openings and the installed units are sealed with low-expanding spray foam sealant, closed cell foam backer rod, spray applied insulation, or other suitable sealant and foam insulation combination.
- Cellulose, fiberglass or rock wool batt insulation is NOT acceptable as a sealant but can be used as a backing for a sealant (such as caulk).
- Photo of filled weight pocket before sash is re-installed—OR—rater verification

Exceptions:

- None

Rationale:

- Weight pockets are responsible for considerable air leakage and subsequent heat loss.
- Expanding foam insulation creates an excellent air barrier and insulator.
- Older windows were typically built into the wall framing without flashing, therefore, water can enter from the exterior. Additionally, no vapor barrier or retarder typically exists on the interior, allowing for significant moisture migration into the wall cavity. Best practice is to use an air sealant and high R-value insulator

Considerations:

- None

Resources:

[Thank You Sponsors - Together We Improve Homes & People's Lives](#)

- TBD

Elective Credits for Section 3D:

3D-1_ Improve existing windows that have U-factor of 0.56 or greater

** Note: If no label on single pane glass, assume U value = 0.56 or greater. If no label on insulated glass assume U value = 0.40.

General Requirements:

1. Select one of the window improvement options that matches the work being done on the project.
2. If window improvement strategies being used on the project are significantly different from any of the options, make a proposal using the Innovation Section of the checklist and contact GreenStar for assistance.
3. Make notes on plans and/or specifications describing the work to be done and materials to be used.
4. Provide post-construction photo—OR—rater verification

Exceptions:

- None

Select only one:

3D-1a_ Improve double hungs with pipe, foam and weather stripping method -OR - ploughed sashes with JAMB LINER. Without replacement of sash. (minimum 50% of windows on house)

3D-1b_ Improve double hungs with pipe, foam and weather stripping method. -OR - ploughed sashes with JAMB LINER. Without replacement of sash. (minimum 90% of windows on house)

Requirements:

1. Insert pipe into weight pocket to serve as a track for the weight to move in.
2. Air seal and insulate remaining space in weight pocket with foam insulation.
3. Air seal window sash with weather-stripping.

Rationale:

- Can significantly improve energy efficiency because of air sealing.
- Savings in energy efficiency will likely pay for the cost of the improvements.
- Can significantly improve indoor comfort levels because of air sealing, but not to the same comfort level of a new window.
- Least expensive option.

[Thank You Sponsors - Together We Improve Homes & People's Lives](#)

- Most resource efficient option. Preserves existing materials and avoids using a lot of embodied energy to make new windows.
- Most authentic in appearance

Considerations:

- Not as comfortable as new windows
- More likely to attract condensation when the weather is very cold or if occupants require comfortable humidity levels.
- More maintenance costs than low-maintenance new window components.

Resources:

- TBD

3D-1c_ Improve double hungs with COMPRESSION TRACK method. With new sash and insulated glass. (minimum 50% of windows on house)

3D-1d_ Improve double hungs with COMPRESSION TRACK method. With new sash and insulated glass. (minimum 90% of windows on house)

Requirements:

1. Remove and reuse or recycle existing sash.
2. Remove and reuse or recycle weights from weight pocket. Air seal and insulate weight pocket with spray or pour-type foam insulation.
3. Install compression track and new sash.

Rationale:

- Can significantly improve energy efficiency because of air sealing.
- Can significantly improve indoor comfort levels because of air sealing and increased U-factor.
- Can reduce maintenance costs over time, if low maintenance surfaces are chosen for sash.

Considerations:

- Moderately expensive to buy new sash and for labor to air seal existing frame.
- Much higher amount of embodied energy than keeping existing windows.
- Window will typically NOT pay for itself with the money saved in energy efficiency.
- Typically less authentic in appearance than when original sash are preserved.

Resources:

- TBD

3D-1e_ Improve any window type with full frame insert replacement unit having

[Thank You Sponsors - Together We Improve Homes & People's Lives](#)

U-factor of 0.32 (minimum 50% of windows on house)

3D-1f_ Improve any window type with full frame insert replacement unit having U-factor of 0.32 (minimum 90% of windows on house)

3D-1g_ Improve any window type with full frame insert replacement unit having U-factor of 0.29 to 0.31 (minimum 50% of windows on house)

3D-1h_ Improve any window type with full frame insert replacement unit having U-factor of 0.29 to 0.31 (minimum 90% of windows on house)

3D-1i_ Improve any window type with full frame insert replacement unit having U-factor of 0.25 to 0.29 (minimum 50% of windows on house)

3D-1j_ Improve any window type with full frame insert replacement unit having U-factor of 0.25 to 0.29 (minimum 90% of windows on house)

3D-1k_ Improve any window type with full frame insert replacement unit having U-factor of < 0.24 (minimum 50% of windows on house)

3D-1L_ Improve any window type with full frame insert replacement unit having U-factor of < 0.24 (minimum 90% of windows on house)

Requirements:

1. Remove and reuse or recycle existing sash.
2. Remove weights from weight pocket. Air seal and insulate weight pocket with spray or pour-type foam insulation.
3. Install new full frame insert replacement unit.

Rationale:

- Can significantly improve energy efficiency (mostly because of air sealing).
- Can significantly improve indoor comfort levels because of air sealing and increased U-factor.
- Can reduce maintenance costs over time, if low maintenance surfaces are chosen.

Considerations:

- Typically very expensive.
- Much higher amount of embodied energy than keeping existing windows.
- Window will typically NOT pay for itself with the money saved in energy efficiency.

[Thank You Sponsors - Together We Improve Homes & People's Lives](#)

Resources:

- TBD

3D-2_ Material type for replacement windows.

Select Only One:

- 3D-2a_ Replacement windows are wood
- 3D-2b_ Replacement windows are fiberglass
- 3D-2c_ Replacement windows are wood with metal clad exterior

Requirements:

- Provide receipt or manufacturer documentation from product.

Rationale:

- The points for this credit are for Resource Efficiency/Durability. Energy efficiency in replacement applications is incorporated into credit 3D-1 above.
- Different materials affect the durability of the windows and also require differing amounts of embodied energy for manufacture.
- Wood is a renewable resource with relatively low embodied energy, but it requires more maintenance over time.
- Fiberglass is strong, will not corrode, and has expansion and contraction properties that are very similar to the glazing, which means the seals between the sash and the glass will most likely last longer. However, it does have a high amount of embodied energy.
- Aluminum cladding on wood makes it more durable, and is an efficient use of the aluminum since it is a thin layer, but it does have a high amount of embodied energy and can corrode in some harsh environments.

Considerations:

- TBD

Resources:

- TBD

3D-3_ Window unit air leakage rating <0.30 cfm/sq. ft.

Requirements:

- Provide manufacturer documentation of air leakage (NFRC Label).

Exceptions:

- None

[Thank You Sponsors - Together We Improve Homes & People's Lives](#)

Rationale:

- Preventing air leakage saves energy, improves durability, and improves comfort.

Considerations:

- A house that is very tight needs adequate fresh air supply for the health of the occupants. Usually this needs to be mechanically supplied.

3D-4_ All replacement windows installed on east and west have SHGC <0.35

Requirements:

- Weighted average Solar Heat Gain Coefficient (SHGC) of all glazing on east and west sides of house shall be less than 0.35. See Table 3D-4 for easy weighted average calculator.
- Provide manufacturer documentation of SHGC

Exceptions:

- 5% of east and west glazing can be excluded from calculation.

Rationale:

- A solar path diagram for Minnesota would show that there are a lot of times during the day during the summer months when the sun is low in the eastern or western sky, and cannot be blocked by overhangs or other horizontal shading devices.
- A low SHGC on east and west facing windows helps to prevent overheating during these times.
- During the winter months when we would want to allow the sun to penetrate into the building, the sun never gets to a position that is low in the eastern or western sky.
- Therefore the low SHGC of eastern and western windows helps keep the house cool in the summer, and is NOT a liability in the winter.

Considerations:

- None

Resources:

- A free software program, REScheck (www.energycodes.gov), can perform the weighted average calculation for SHGC.

Resources:

- TBD - Create Table 3D-4 SHGC Weighted Average Calculator. Add (SHGC x Area) for each window, then divide this number by the total of all of the Areas.

[Thank You Sponsors - Together We Improve Homes & People's Lives](#)

3D-5_ Add exterior shading to existing windows on south and west side of home, such as awnings on south or west, vertical fins on west, etc.

Requirements:

- Documentation required showing projection size including depth of overhang, height of window and a diagram of sun angles for winter and summer.
- Roof overhangs also qualify if properly sized and documented.
- Proper sizing ensures effective use of materials and that strategies have been well considered.

Exceptions:

- None

Rationale:

- Shading against summer sun on the south and west windows is most important since these are the times of the day in the summer when overheating is most prevalent.
- Vertical fin shading devices on the west are a more effective orientation to block the western summer sun than horizontal shades.
- Exterior shading is better than interior shades; by the time the sun hits an interior shade, some of the heat energy has already entered the house.
- See also Rationale for 3D-4
- Exterior

Considerations:

- None.

Resources:

- Pilkington Sun Angle Calculator
www.sbse.org/Resources/sac/PSAC_Manual.pdf

3D-6_ Install exterior solar shades on clear-glazed windows

Requirements:

- Preconstruction photo of existing
- Post construction photo of existing—OR—rater verification
- At a minimum, provide solar shade screening with a shading coefficient of 0.7 or greater on windows facing east and west. Shade screening shall be installed on exterior of window glazing (EC, 19.3)
- Remove or retract screens in winter for additional light and heat gain.

[Thank You Sponsors - Together We Improve Homes & People's Lives](#)

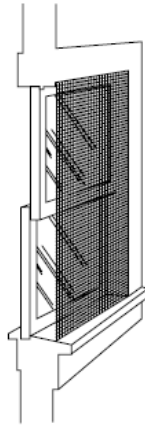

Exceptions:

- None

Rationale:

- A solar path diagram for Minnesota would show that there are a lot of times during the day during the summer months when the sun is low in the eastern or western sky, and cannot be blocked by overhangs or other horizontal shading devices.
- Exterior solar shades on east and west facing windows helps to prevent overheating during these times.

Considerations:

- None

Resources:

- Lighter colored screens have greater heat reflectance, where darker colors will have higher visibility from indoors.
- Exterior solar shades save up to 60% of conditioning costs

3D-7_ Install storm windows on double hung or fixed windows

Requirements:

- Notes on plan and/or specifications stating addition of storm windows
- Post-construction photo—OR—rater verification

Exceptions:

- None

Rationale:

[Thank You Sponsors - Together We Improve Homes & People's Lives](#)

- Storm windows help improve energy efficiency by creating a dead air space between them and the main window.
- They improve durability by protecting the inner main window from rain, ice and snow.

Considerations:

- None

Resources:

- TBD

3D-8_ Install, adjustable interior solar shades, or reflective blinds to minimum 80% of all (existing and new) east, west, and south windows/skylights, which have no exterior shading to block summer sun

Requirements:

- Preconstruction photo of existing
- Post construction photo of existing—OR—rater verification

Exceptions:

- None

Rationale:

- Where exterior shades are not a good option, interior shades can help to block solar gain when it is not desirable.

Considerations:

- TBD

Resources:

- TBD

3D-9_ Install low-e film on interior side of clear-glazed windows, skylights and doors

Requirements:

- Before and after photo of areas where film was applied.

Exceptions:

- None

Rationale:

[Thank You Sponsors - Together We Improve Homes & People's Lives](#)

- Adding low-e film to existing windows that have clear glazing achieves some of the improved performance that normally comes with replacing the whole sash or window unit, without the cost and embodied energy of replacing the whole window, door or skylight unit itself.
- Low-e film is like a one-way filter that allows the sun's radiant energy to pass through the glass to enter the house, but it also helps to reflect radiant heat back into the house to help retain that heat.

Considerations:

- Coatings on the glass do affect the color slightly.

Resources:

- TBD

3D-10_ Install storm doors

Requirements:

Pre-construction photo of existing conditions to be improved

- Post-construction photo—OR—rater verification

Exceptions:

- None

Rationale:

- Storm doors help improve energy efficiency by creating a dead air space between them and the main door.
- They also improve durability by helping to protect the inner door from the weather.

Considerations:

- None

Resources:

- TBD

3D-11_ Connecting doors between living space and garage are improved with gaskets or made substantially airtight with weather stripping, air sealing door sweep, thresholds, etc. Also, new automatic closer verified to be working or replaced.

Requirements:

Pre-construction photo of existing conditions to be improved

1. Post-construction photo—OR—rater verification

[Thank You Sponsors - Together We Improve Homes & People's Lives](#)

Exceptions:

- None

Rationale:

- Garages have a lot of pollutants that are best kept out of the house.
- The door between the garage and the house plays an important role in this and should be kept closed and airtight as much as possible.

Considerations:

- None

Resources:

- TBD

3D-12_ Install new weather-strip AND thresholds or air sealing door sweeps on all existing entry doors

Requirements:

Pre-construction photo of existing conditions to be improved

1. Weather-stripping at sides and head is required.
2. Tightly sealing threshold—OR—tight fitting door sweep is required at the bottom of the door.
3. Post-construction photo—OR—rater verification

Exceptions:

- None

Rationale:

- Properly fitting weather-stripping, thresholds and door sweeps all help prevent air leakage around entry doors. They should be maintained often.

Considerations:

- Houses with little air leakage are desirable, but require adequate fresh air ventilation.

Resources:

- TBD

3D-13_ Home equipped with covered entryways that extend three feet out from every exterior door. Existing covered entries also qualify.

[Thank You Sponsors - Together We Improve Homes & People's Lives](#)

Select Only One:

- 3D-13a_ 1 entry.
- 3D-13b_ 2 or more entries

Requirements:

- Post-construction photo—OR—rater verification

Exceptions:

- None

Rationale:

- Covers at entries improve durability of the entry door assemblies by protecting them from the weather.

Considerations:

- None

Resources:

- TBD

3D-14_ Doors at entry between conditioned and unconditioned space and/or between interior and exterior

Select all that apply:

- 3D -14a_ Replacement Door with 1/2 glass or less U-factor is 0.18 to 0.20 (1 door)
- 3D -14b_ Replacement Door with 1/2 glass or less U-factor is 0.18 to 0.20 (2 or more doors)
- 3D -14c_ Replacement Door(s) with 1/2 glass or less U-factor is ≤ 0.17 . (1 door)
- 3D -14d_ Replacement Door(s) with 1/2 glass or less U-factor is ≤ 0.17 . (2 or more doors)
- 3D -14e_ Replacement Door with 1/2 glass or more U-factor is 0.31 to 0.47. (1 door)
- 3D -14f_ Replacement Door with 1/2 glass or more U-factor is 0.31 to 0.47. (2 or more doors)
- 3D -14g_ Replacement Door(s) with 1/2 glass or more U-factor is ≤ 0.30 . (1 door)
- 3D -14h_ Replacement Door(s) with 1/2 glass or more U-factor is ≤ 0.30 . (2 or more doors)

Requirements:

- Notes on drawings and/or specifications indicating work to be done or product to use
- Provide manufacturer documentation

[Thank You Sponsors - Together We Improve Homes & People's Lives](#)

Exceptions:

- None

Rationale:

- 3D-14a - 3D-14h are for energy performance characteristics of replacement doors.
- A low U-factor indicates better energy performance.

Considerations:

- None

Resources:

- TBD

3D -14i_ Door(s) are wood

3D -14j_ Door(s) have metal outer skin (e.g., aluminum or steel)

3D -14k_ Door(s) have fiberglass outer skin

Requirements:

- Notes on drawings and/or specifications indicating work to be done or product to use
- Provide manufacturer documentation

Exceptions:

- None

Rationale:

- 3D-14i → 3D-14k are for durability characteristics of replacement doors.
- Wood has low embodied energy, a long life span and a respectable energy rating.
- Steel doors have an overall durability similar to wood. On one hand, steel typically needs less repainting or staining, but on the other hand it dents easily, which can result in an increased need for repainting or complete door replacement. Steel has a higher embodied energy than other doors.
- Fiberglass is very durable, holds paint and stain well, and is not prone to denting like metal. Other benefits of fiberglass include its similar dimensional stability as the glazing itself, which means the glazing seals should last longer. The downside of fiberglass is its high-embodied energy.

Considerations:

[Thank You Sponsors - Together We Improve Homes & People's Lives](#)

- None

Resources:

- TBD

3D -14L_ Wood used in door(s) (if any) has Forest Stewardship Council Certification (90% of doors containing wood)

Requirements:

- Notes on drawings and/or specifications indicating work to be done or product to use
- Provide manufacturer documentation

Exceptions:

- None

Rationale:

- Forest Stewardship Council certification ensures that the wood is coming from a well-managed forest.

Considerations:

- None

Resources:

- TBD

3D-15_ 20-year warranty on all insulated glazing, sash and frame for replacement windows and/or doors having a frame of wood or wood with cladding

Requirements:

1. Copy of warranty documentation.

Exceptions:

- None

Rationale:

- Most window and door manufacturers currently only offer a 10-year warranty for the frame, and a 20-year warranty for the glazing and seals.
- Some companies have started to increase this to 20 years for the whole unit. These longer warranties are encouraged.

Considerations:

[Thank You Sponsors - Together We Improve Homes & People's Lives](#)

- None

Resources:

- TBD

3E -Improvements To Existing Attics That Are Remaining Unfinished

The main things that should be addressed in an existing attic are as follows.

1. Air leaks (a.k.a. Attic By-Passes)

Eliminate any ways for air leaks into the attic from the house below. Typical locations where air leaks into the attic include:

- Penetrations from plumbing, electrical, and mechanicals (especially recessed can lights).
- Locations where the walls and ceiling meet in the rooms below.
- Attic access doors and/or panels.

2. Total R-value of attic insulation.

Adding R-value to a certain point will improve the home's energy efficiency. The greater the R-value, the less improvement will be realized by each additional increase in R-value. Given the materials available today, it is typically very expensive to significantly improve energy performance much beyond R-60.

3. Ensure that the roof/attic ventilation system is working as designed.

It is important to note that adding new or additional ductwork through an unfinished attic is NOT a good approach. Ducts can pick up insulation, dirt, and other particles and carry them to other parts of the home and to the furnace. Also ducts in unconditioned spaces are very energy inefficient. Any existing ducts should be examined and reviewed per Section 5 - Mechanicals.

3E-1_ Air seal all attic penetrations* (all plumbing, electrical and HVAC penetrations plus any chases), and add continuous insulation on floor of attic to R-38

* Note: Air sealing penetrations (plumbing chase, electrical penetrations) requires the use of caulk, can-type expanding foam, or spray foam. The insulation on the floor may be batt or other material.

- An insulated attic hatch shall be built to open the attic and form an airtight seal when closed. The attic hatch must accommodate the "hideaway stairs" (if one exists) and be insulated.

[Thank You Sponsors - Together We Improve Homes & People's Lives](#)

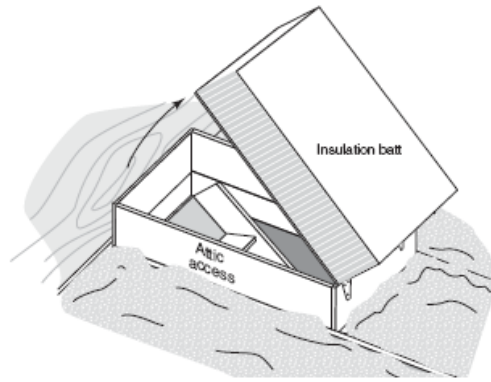

Requirements:

1. Provide notes on drawings and/or specifications showing insulation value.
2. Install new or extend existing attic vent chutes for anticipated insulation depth.
3. Attach insulation info card near attic access door, which lists:
 - Date insulation installed.
 - R-value per inch of insulation depth. Include the recommended installed depth and the expected settled depth for blown-in insulation types.
 - Target Total R-value installed.
4. Install insulation depth markers every 100 square feet to show actual depth of insulation installed.
5. Post-construction photo—OR—rater verification

Exceptions:

1. Ceilings with unconditioned attic space above should have complete coverage of attic insulation equal to or greater than a WEIGHTED AVERAGE OF R-38. A maximum of 10% of ceiling area may be as low as R25 to accommodate elevated attic flooring for storage.
Note: This means that if some areas are between R25 and R38, then other areas must be over R38 to make up for it.

Rationale:

- Insulation info card and depth markers are an excellent way to help installers know they are getting enough insulation depth throughout the attic.
- It helps code inspectors and homeowners easily understand what insulation type and R-value the design called.
- It helps monitor how much the insulation settles, which is common for blown-in insulation.

Considerations:

- Care must be taken to not block attic venting air spaces when installing insulation.

[Thank You Sponsors - Together We Improve Homes & People's Lives](#)

Resources:

- TBD

3E-2_ Improve existing unfinished attic w/ advanced Insulation materials & techniques.
(based on R-value X Sq.Ft.)

General Considerations:

- When R-value gets above R60, there is typically very little increase in performance without significant cost and space requirements.

General Requirements:

- Multiply R value X sq. ft.

Select all that apply:

3E-2a_ Insulation with minimum 20% recycled content for at least 50% of applications (based on R-value x sq. ft.)

Requirements:

- Recycled content must be certified by Scientific Certification Systems (SCS) or the manufacturer. SCS is on the web at www.scs1.com
- Manufacturer Specifications

3E-2b_ All-natural insulation, such as cotton batt, is used for at least 50% of applications. (Soy based foam insulation is not considered "all natural" and is not eligible for credit in this category)

Requirements:

- Rater Sign Off

3E-2c_ Attic insulation total R44 to R49 (flat or vaulted)

Requirements:

- Rater Sign Off

3E-2d_ Attic insulation total R50 or more (flat or vaulted)

Requirements:

- Rater Sign Off

3E-2e_ Add 1" minimum foil face polyisocyanurate insulation to sloped roof / ceiling for thermal break and vapor barrier

3E-2f_ Add 2" rigid insulation to interior of sloped roof / ceiling for thermal break and vapor barrier

Requirements:

- Manufacturer documentation to demonstrate insulation qualifies as Class 1 or Class 2 Vapor Retarder (1 perm or less).

[Thank You Sponsors - Together We Improve Homes & People's Lives](#)

- Insulation must be taped with the proper tape for the insulation type and sealed at edges to achieve vapor retarder rating.
- Rater Sign Off

3E-2g_ Energy Heel: minimum R38 to outside face of exterior walls

Requirements:

- Rater Sign Off

3E-2h_ Access openings to new attics and new knee wall areas are well insulated Horizontal Attic Access = R38 min and Vertical Knee Wall Access = R23 minimum

Requirements:

- Rater Sign Off

3E-3_ Improve framing in attics being used as, or converted to unheated storage. Install extensions (e.g., 2X scrap framing, 1/2 I-Joist, etc.) on existing attic joists to increase space for R38 or greater attic insulation. Install new flooring or re-install existing flooring (preferred).

Requirements:

Pre-construction photo of existing conditions to be improved.

- Perform work as described in credit description above.
- Post-construction photo—OR—rater verification.

The drawing below gives a typical example of how this is done.

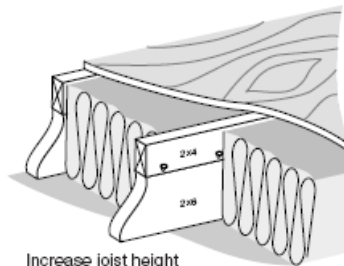

Increase joist height under decking to raise R-value for ceiling

Increase height of joists for utility flooring in attic to add more insulation.

Exceptions:

- None

[Thank You Sponsors - Together We Improve Homes & People's Lives](#)

Rationale:

- This credit gives incentive and additional points for increasing the insulation levels in existing unheated attics that have flooring, when these attics are to remain unheated. Typically the existing depth of the ceiling structure is not large enough to even achieve the minimum R-values that are required in new construction.
- Homes that currently have under R38 can get credit for increasing to R38 or more.
- Homes that are currently at R38 can get credit for increasing to R42 or more.

Considerations:

- Care must be taken to not compress insulation or displace it during the process of installing flooring and/or moving in storage items.

Resources:

- TBD

3E-4_ Unfinished attic remaining unfinished - Improved w/ ADVANCED AIR SEALING materials & techniques.

Select all that apply:

- 3E-4a_ Seal all attic by-passes (spot seal or spray foam entire attic floor)
- 3E-4b_ Access openings to new attics and new knee wall areas are weather-stripped
- 3E-4c_ Provide insulation wind baffle or other air barrier to block wind washing at all attic eave bays in roof assemblies with soffit vents

Requirements:

- Notes on drawings and/or specifications indicating work to be done or product to use.
- Rater Sign Off

Exceptions:

- None

Rationale:

- Improves energy efficiency and durability

Considerations:

- None

Resources:

- TBD

[Thank You Sponsors - Together We Improve Homes & People's Lives](#)

Drawing of attic access door

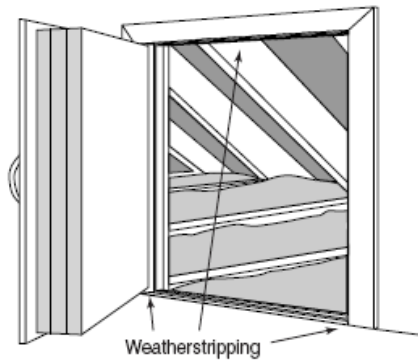

3E-5_ 1) Inspect and document existing roof ventilation system (possibly already done if measure 1B-1 was performed). 2) Design and specify venting improvements or conversion to non-vented system. (Projects not needing changes or improvements also qualify.)

Requirements:

- Do documentation and design work as described in credit description above.
- Provide notes on drawings and/or specifications describing work to be done.
- Post-construction photo—OR—rater verification.

Exceptions:

- None

Rationale:

- If a vented roof is part of the overall design of the house, then it must be balanced and working properly.
- Most houses are designed to have a vented roof. Usually it is a passive system, but occasionally there is one that is mechanically vented. Regardless of the type, it is very common to find them not operating as they should. Many times the proper vent holes were not installed from the beginning. If they do exist, they have often become blocked over time from dust and dirt or carelessly installed insulation, etc.
- If roof ventilation is not working properly, the effects, include:
 - Damage to the building structure
 - Water leaking through the ceiling of upper rooms
 - Wet attic insulation, which has very little R-value, and keeps the structure wet, which makes structural decay progress more rapidly.

Considerations:

[Thank You Sponsors - Together We Improve Homes & People's Lives](#)

- See Rationale above.

Resources:

- TBD - See calculator spreadsheet for balanced roof attic ventilation in checklist.

3E-6_ Implement design from 3E-5. Install-new and/or improve-existing eave vents, vent chutes, roof vents—OR—Convert to non-vented. (Non-vented designs must be pre-approved by building code official.) (Projects not needing changes or improvements also qualify.)

Requirements:

- Perform work described in design/specification portion of credit 3E-5.
- Post-construction photo—OR—rater verification

Exceptions:

- None

Rationale:

- See 3E-5

Considerations:

- See 3E-5

Resources:

- TBD

3F - Finishing Unfinished Attics

The strategies for finishing an unfinished attic and for making improvements to an already finished attic are basically the same, and therefore the credits are repeated. Finished attics that have not been finished using best practices can be huge sources of heat loss and durability problems associated with ice dams, mold, etc. Therefore, it is highly recommended that improvements be made to finished attics when it is determined that they were not initially finished using best practices. By separating these two subsections, there is more incentive and more points available to do so.

The main issues with finishing unfinished attics are similar to improving attics that are to remain unfinished.

1. Air leaks (a.k.a. Attic By-Passes)
2. Total R-value of attic insulation.
3. Ensure that the roof/attic ventilation system is working as designed.

See also Subsection 3E for more details on these.

[Thank You Sponsors - Together We Improve Homes & People's Lives](#)

Additional conditions and issues that are common when attics are converted into living space include the following.

1. Knee walls. Proper insulation and air sealing of knee walls is important.
2. Sloped ceilings due to the existing roof structure. Proper air sealing and insulation on sloped ceilings is important and typically presents some unique challenges. Most older houses were not designed and built to accommodate the insulation levels that we know are important today.

3F-PR1_ No recessed light fixtures may be installed unless they fully comply with recessed lighting requirements in credit 3PR-7

- It is extremely difficult to properly air seal and insulate around a recessed light fixture

Requirements:

- See 3PR-7

Exceptions:

- See 3PR-7

Rationale:

- See 3PR-7

Considerations:

- See 3PR-7

Resources:

- See 3PR-7

3F-1_ Air seal all attic penetrations (at all plumbing, electrical and HVAC penetrations plus any chases, open wall cavities, dropped ceilings and soffits)

Requirements:

Pre-construction photo of existing conditions to be improved.

- Notes on drawings and/or specifications indicating work to be done.
- Pre-drywall photo—OR—rater verification

Exceptions:

- None

Rationale:

[Thank You Sponsors - Together We Improve Homes & People's Lives](#)

- Air leaks negatively affect energy efficiency, comfort and building durability.

Considerations:

- None

Resources:

- TBD

3F-2_ Seal existing recessed light fixtures to drywall with gasket, caulk or foam and add air sealed foam box or dome at all locations where they penetrate into the unconditioned area of the attic

Requirements:

- Document existing recessed can lights that are in the insulated envelope. (Note: This may already be happening as a part of measure 1B-1, if that was selected.)
- Cans must be inspected and documented as to whether they are Washington State Energy Code (WSEC) compliant, and if they are Insulation Contact (IC) rated.
- Must perform before and after blower door test and infrared thermal imaging of recessed cans that are in an insulated ceiling and document the results.
- Must inspect the cans from the attic-side (if possible) and document the results.
- Follow the instructions on the drawings below to air seal and insulate the recessed cans.
- Perform Blower Door Test and infrared thermal imaging after improvements are made to demonstrate the air sealing and insulating was done well.
- Post-construction photo—OR—rater verification

Exceptions:

- Cans that are not accessible from the attic side may need to be removed and worked on from the finish side.
- Existing recessed cans that are in a very tight location, which does not allow for adequate insulation must at least be air sealed with foam box and insulated to greatest amount possible. If these cans can simply be removed, that is an even better solution.

Rationale:

- IC-rated recessed light fixtures penetrating an insulated space are difficult to properly air seal and are not considered a sustainable building strategy.

Considerations:

- None

Resources:

[Thank You Sponsors - Together We Improve Homes & People's Lives](#)

- TBD

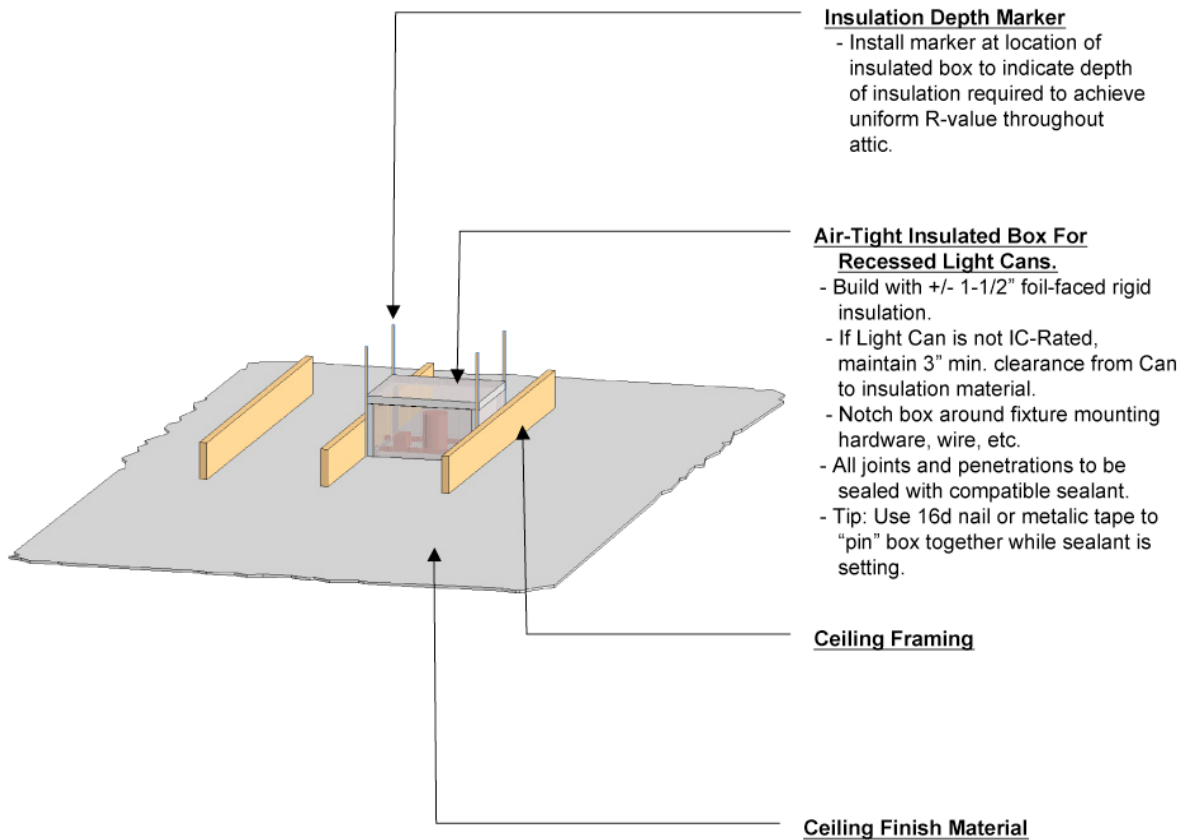

[Thank You Sponsors - Together We Improve Homes & People's Lives](#)

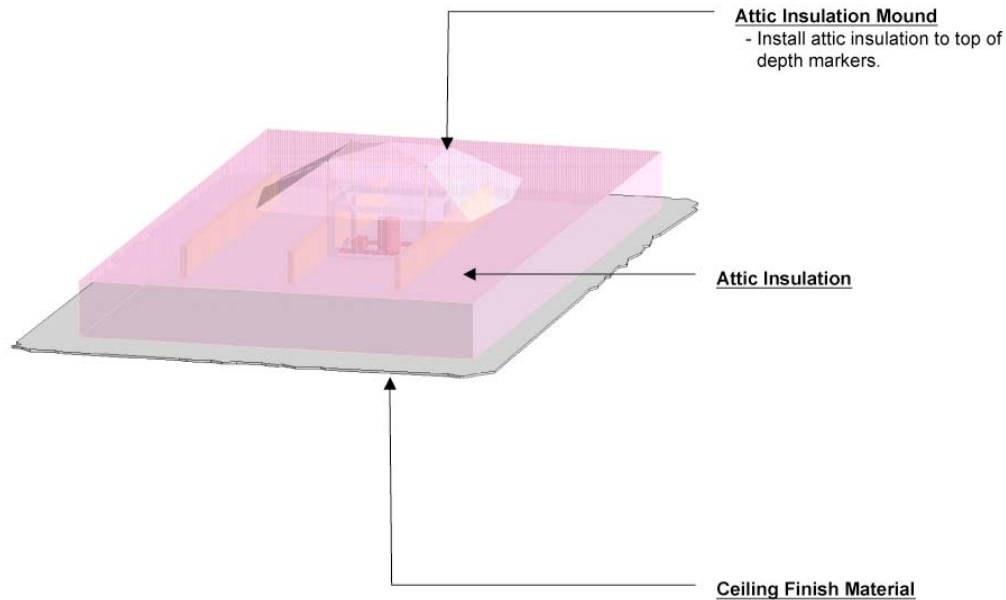

3F-3_ Air barrier on dropped ceiling/soffit is in full contact with insulated framing and any gaps are fully sealed with caulk, foam, or fire-rated sealant

Requirements:

- Notes on drawings and/or specifications indicating work to be done.
- Air barrier (and insulation) should typically be installed before dropped ceilings and soffits are constructed.
- Pre-drywall photo—OR—rater verification

Exceptions:

- None

Rationale:

- Dropped ceilings and soffits are notorious places where the air barrier is interrupted. Alternately, if it does exist, it is often not in contact with the insulation, as it should be.

Considerations:

- None

[Thank You Sponsors - Together We Improve Homes & People's Lives](#)

Resources:

- TBD

3F-4_ Air barrier in staircase framing adjacent to exterior wall/attic is fully aligned with insulated framing and any gaps are fully sealed with caulk or foam

Requirements:

- Notes on drawings and/or specifications indicating work to be done.
- Air barrier (and insulation) should typically be installed before staircases are constructed adjacent to exterior walls.
- Pre-drywall photo—OR—rater verification

Exceptions:

- Sometimes if closed cell spray foam insulation is used, it is possible to obtain good thermal, air, and vapor barriers in place after the staircase framing is in place.

Rationale:

- Dropped ceilings and soffits are notorious places where the air barrier is interrupted. Alternately, if it does exist, it is often not in contact with the insulation, as it should be.

Considerations:

- None

Resources:

- TBD

3F-5_ Air sealing and Insulation improvements to unfinished knee wall areas

Select all that apply:

- 3F-5a_** Knee Walls = R-15 to R-21 & floors behind knee walls = R-38 to R-41 (assumes unconditioned knee wall area) - OR - Sloped ceiling behind knee walls R - 38 to R-41 (for an unvented attic assembly) (assumes risidually conditioned knee wall area)
- 3F-5b_** Knee Walls = R-22 to R-29 & floors behind knee walls = R-42 to R-49 (assumes unconditioned knee wall area) - OR - Sloped ceiling behind knee walls R - 42to R-49 (for an unvented attic assembly) (assumes risidually conditioned knee wall area)
- 3F-5c_** Knee Walls = R-30 & floors behind knee walls = R-50 (assumes unconditioned knee wall area) - OR - Sloped ceiling behind knee walls R -

[Thank You Sponsors - Together We Improve Homes & People's Lives](#)

- 50 (for an unvented attic assembly) (assumes residually conditioned knee wall area)
- 3F-5d_** Use spray-foam to air seal and insulate knee walls and floor—OR—sloped ceiling

Requirements:

- Document existing insulation levels.
- Notes on drawings and/or specifications indicating work to be done.
- If insulating involves open walls or ceilings, then pre-drywall photo of areas insulated—OR—rater verification
- Post-construction photo of areas insulated—OR—rater verification

Exceptions:

- None

Rationale 3F-5a - 3F-5c:

- Important for energy efficiency, durability and comfort.
- Two main approaches exist for air sealing and insulating the knee wall space.
 1. Air seal and insulate the floor and wall of the knee wall area making the knee wall area unconditioned space
 2. Air seal along the sloped ceiling (roof) of the knee wall area, which means it will receive some residual conditioning from the main living area. Sometimes this is preferred to allow the knee wall area to function as a more frequently used storage space. This might also be preferred if the knee wall space is already being used for storage, and already has flooring. It would potentially require more time and effort to remove the flooring, air seal/insulate the floor, and then replace the flooring than it would be to just insulate the ceiling.

Rationale 3F - 5d:

- Spray foam does a better job with air sealing, which improves energy efficiency and indoor environmental quality over other insulation systems.

Considerations:

- None

Resources:

- TBD

3F-5e_ Air seal and insulate critical areas (R30 minimum) (e.g. rim joist at eave, joist cavity under knee wall and cavity at raft cavity at top of knee wall)

Requirements:

[Thank You Sponsors - Together We Improve Homes & People's Lives](#)

- Pre-construction photo of areas needing improvement. Notes on drawings and/or specifications describing improvements to be done
- If insulating involves open walls or ceilings, then pre-drywall photo of areas insulated—OR—rater verification
- The rim joist at the eave and the rafter cavity at the top of the knee wall need to be air sealed and insulated regardless of the approach taken to improve the knee wall area.
- The joist cavity under the knee wall only needs to be addressed if the Floor and Wall approach is chosen.
- Post-construction photo of areas insulated—OR—rater verification

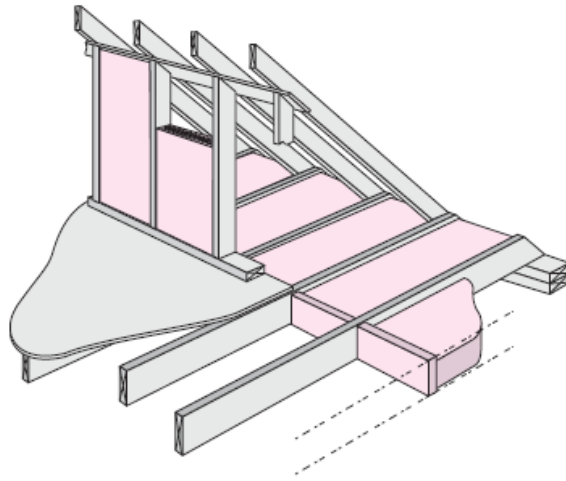

- Sheathing or blocking must extend down between the flat ceiling joists to seal the floor joist cavities. Sheathing on air impermeable insulation is not required unless mandated by fire code.

[Thank You Sponsors - Together We Improve Homes & People's Lives](#)

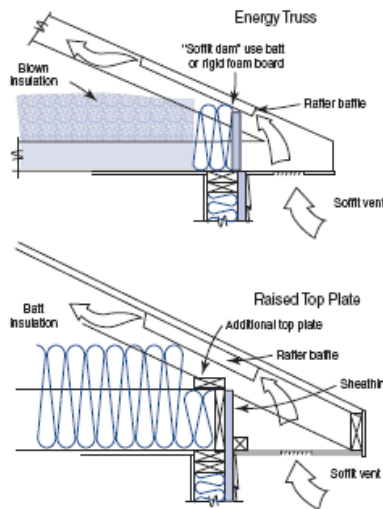
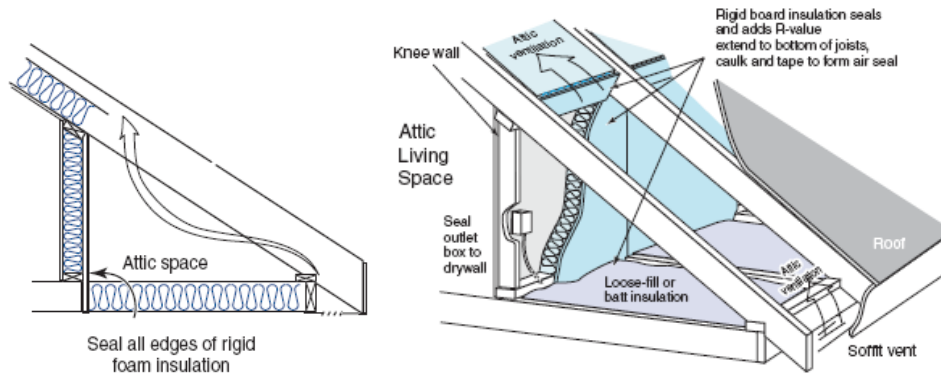

Exceptions:

- None

Rationale:

- Important for energy efficiency, durability, and comfort.

Considerations:

- None

Resources:

- TBD

[Thank You Sponsors - Together We Improve Homes & People's Lives](#)

3F-6_ Improvements to UNFINISHED vaulted and tray ceilings in living area

Select all that apply:

- 3F-6a_ R25 to R37
- 3F-6b_ R38 to R42
- 3F-6c_ R43 or better
- 3F-6d_ Air seal and insulate sloped roof / ceiling with spray foam.
- 3F-6e_ Add 3/4" minimum foil face polyisocyanurate (or equivalent) insulation to existing sloped roof / ceiling for thermal break and vapor retarder (seal all seams with tape or equivalent)
- 3F-6f_ Install radiant barrier with air space when improving existing finished sloped roof / ceiling system where R38 insulation is not achievable. Radiant barrier on attic floor does NOT qualify.

Requirements:

- Notes on plans or specifications indicating material to be used and/or work to be done.
- Pre-drywall photo—OR—rater verification

Exceptions:

- None

Rationale 3F-4 (general):

- Existing homes frequently have low amounts of insulation at vaulted or tray ceilings. This credit gives incentive to improve the R-value in those areas.

Rationale 3F-6a:

- R25 assumes 3.5" rafter with R6 per inch closed cell spray foam plus R5 rigid (frequently allowed for remodels using hot roof application when finishing attic space. Typically homeowner must sign-off.
- Other combinations of insulation to achieve specified R-Values can also qualify.

Rationale 3F-6b:

- R38 assumes 5.5" rafter with R6 per inch closed cell spray foam plus R5 rigid—Minnesota code minimum for new construction.
- Other combinations of insulation to achieve specified R-Values can also qualify.

Rationale 3F-6c:

- R43 assumes 11-1/8" I-joist rafter with 7/8" air space + 1" (-R6) foil faced rigid, + 2" closed cell spray foam -R12), + 8" high density fiberglass (R25)
- Other combinations of insulation to achieve specified R-Values can also qualify.

[Thank You Sponsors - Together We Improve Homes & People's Lives](#)

Rationale 3F-6d:

- Spray foam does a better job with air sealing, which improves energy efficiency and indoor environmental quality over other insulation systems.

Rationale 3f-6e:

- Foil faced insulation is a Class 1 Vapor Retarder and applying rigid insulation over the face of the rafters helps prevent thermal bridging through the rafters. Foil must face heated surface of the room.
- Equivalent insulations should have a minimum Class 2 Vapor Retarder rating and similar R-value.

Rationale 3F-6f:

- Where R38 is not achievable, a properly installed radiant barrier on either the topline and/or the bottom side of the insulation can be beneficial.
- If planning to install a radiant barrier on both top and bottom sides of the insulation, special care must be taken to avoid a vapor trap between them. In this situation, the topline radiant barrier should be vapor permeable and the air space above it should be vented.
- Some of the best radiant barriers, such as aluminum foil are also Class 1 Vapor Retarders unless they are perforated (vapor impermeable).

Considerations:

- Included in Rationale paragraphs above.

Resources:

- TBD

3F-7_ Improve weather-stripping and insulation at EXISTING attic and knee wall access openings (Horizontal Attic Access = R38 min and Vertical Knee Wall Access = R23 minimum) Also applies to new access openings being installed in existing attics or knee walls.

Requirements:

- Notes on drawings and/or specifications indicating work to be done.
- Attic hatch, cover, or door is fully gasketed for an airtight fit.
- Insulation fits snugly and is located to create a continuous thermal barrier in the knee wall or attic ceiling when in place.
- Post-construction photo of access opening—OR—rater verification

[Thank You Sponsors - Together We Improve Homes & People's Lives](#)

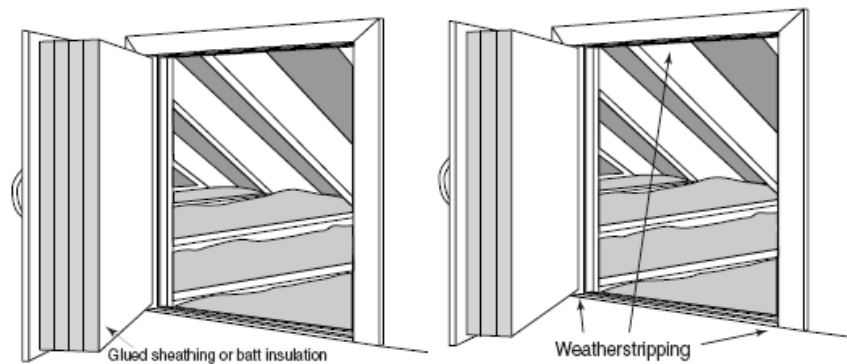

Drawings of vertical knee wall access openings

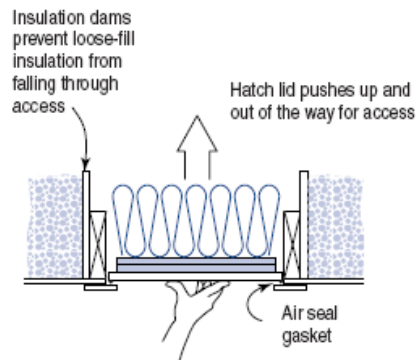

Drawing of horizontal ceiling access opening

Exceptions:

- None

Rationale:

- Air sealing and insulating is extremely important for energy efficiency, durability, and comfort.

Considerations:

- Using fiberglass batts to insulate attic access openings can be problematic. The act of opening and closing the opening can cause small glass fibers to become airborne; these can be irritating and unhealthy.

Resources:

[Thank You Sponsors - Together We Improve Homes & People's Lives](#)

- TBD

3F-8_ 1) Inspect and document existing roof ventilation system (possibly already done if measure 1B-1 was performed). 2) Design and specify venting improvements or conversion to non-vented system. (Projects not needing changes or improvements also qualify.)

Requirements:

- Do documentation and design work as described in credit description above.
- Provide notes on drawings and/or specifications describing work to be done.
- Post-construction photo—OR—rater verification

Exceptions:

- None

Rationale:

- If a vented roof is part of the overall design of the house, then it must be balanced and working properly.
- Most houses are designed to have a vented roof. Usually it is a passive system, but occasionally there is one that is mechanically vented. Regardless of the type, it is very common to find them not operating as they should. Many times the proper vent holes were not installed from the beginning. If they do exist, they have often become blocked over time from dust and dirt, or carelessly installed insulation.
- If roof ventilation is not working properly, the effects include the following.
 - Damage to the building structure
 - Water leaking through the ceiling of upper rooms
 - Wet attic insulation, which has very little R-value, and keeps the structure wet, which makes structural decay progress more rapidly.

Considerations:

- See Rationale above.

Resources:

- TBD - See calculator spreadsheet for balanced roof attic ventilation in checklist.

3F-9_ Implement design from 3F-8. Install-new and/or improve-existing eave vents, vent chutes, roof vents—OR—Convert to non-vented. (Non-vented designs must be pre-approved by building code official.) (Projects not needing changes or improvements also qualify.)

Requirements:

- Perform work described in design/specification portion of credit 3F-8.
- Post-construction photo—OR—rater verification

[Thank You Sponsors - Together We Improve Homes & People's Lives](#)

Exceptions:

- None

Rationale:

- See 3E-8

Considerations:

- See 3E-8

Resources:

- TBD

3G - Improvements To Finished Attics and Roofs

The strategies for finishing an unfinished attic and for making improvements to an already finished attic are basically the same, and therefore the credits are repeated.

Finished attics that have not been finished using best practices can be huge sources of heat loss and durability problems associated with ice dams, mold, etc. Therefore, it is highly recommended that improvements be made to finished attics when it is determined that they were not initially finished using best practices. By separating these two subsections, there is more incentive and more points available to do so.

It is important that any existing ducts running through an insulated attic space be thoroughly sealed to reduce any potential contaminants from being carried throughout the home. It is equally important to consider alternate strategies for new ductwork not to run through the attic space.

3G-PR1_ No recessed light fixtures may be installed unless they fully comply with recessed lighting requirements in credit 3PR-7

-
- It is extremely difficult to properly air seal and insulate around a recessed light fixture

Requirements:

- See 3PR-7

Exceptions:

- See 3PR-7

Rationale:

[Thank You Sponsors - Together We Improve Homes & People's Lives](#)

- See 3PR-7

Considerations:

- See 3PR-7

Resources:

- See 3PR-7

3G-1_ Air seal all attic penetrations (at all plumbing, electrical and HVAC penetrations plus any chases, open wall cavities, dropped ceilings and soffits)

Requirements:

Pre-construction photo of existing conditions to be improved.

- Notes on drawings and/or specifications indicating work to be done.
- Pre-drywall photo—OR—rater verification

Exceptions:

- None

Rationale:

- Air leaks negatively affect energy efficiency, comfort, and building durability.

Considerations:

- None

Resources:

- TBD

3G-2_ Seal existing recessed light fixtures to drywall with gasket, caulk or foam and add air sealed foam box or dome at all locations where they penetrate into the unconditioned area of the attic

Requirements:

- Document existing recessed can lights that are in the insulated envelope. (Note: This may already be happening as a part of measure 1B-1, if that was selected)
- Cans must be inspected and documented as to whether they are Washington State Energy Code (WSEC) compliant, and if they are Insulation Contact (IC) rated.
- Must perform before and after Blower Door Test and infrared thermal imaging of recessed cans that are in an insulated ceiling and document the results.
- Must inspect the cans from the attic side (if possible) and document the results.

[Thank You Sponsors - Together We Improve Homes & People's Lives](#)

- Follow the instructions on the drawings below to air seal and insulate the recessed cans.
- Perform Blower Door Test and infrared thermal imaging after improvements are made to demonstrate the air sealing and insulating was done well.
- Post-construction photo—OR—rater verification

Exceptions:

- Cans that are not accessible from the attic side may need to be removed and worked on from the finish side.
- Existing recessed cans that are in a very tight location, which does not allow for adequate insulation, must at least be air sealed with foam box and insulated to greatest amount possible. If these cans can simply be removed, that is an even better solution.

Rationale:

- IC-rated recessed light fixtures penetrating an insulated space are difficult to properly air seal and are not considered a sustainable building strategy.

Considerations:

- None

Resources:

- TBD

[Thank You Sponsors - Together We Improve Homes & People's Lives](#)

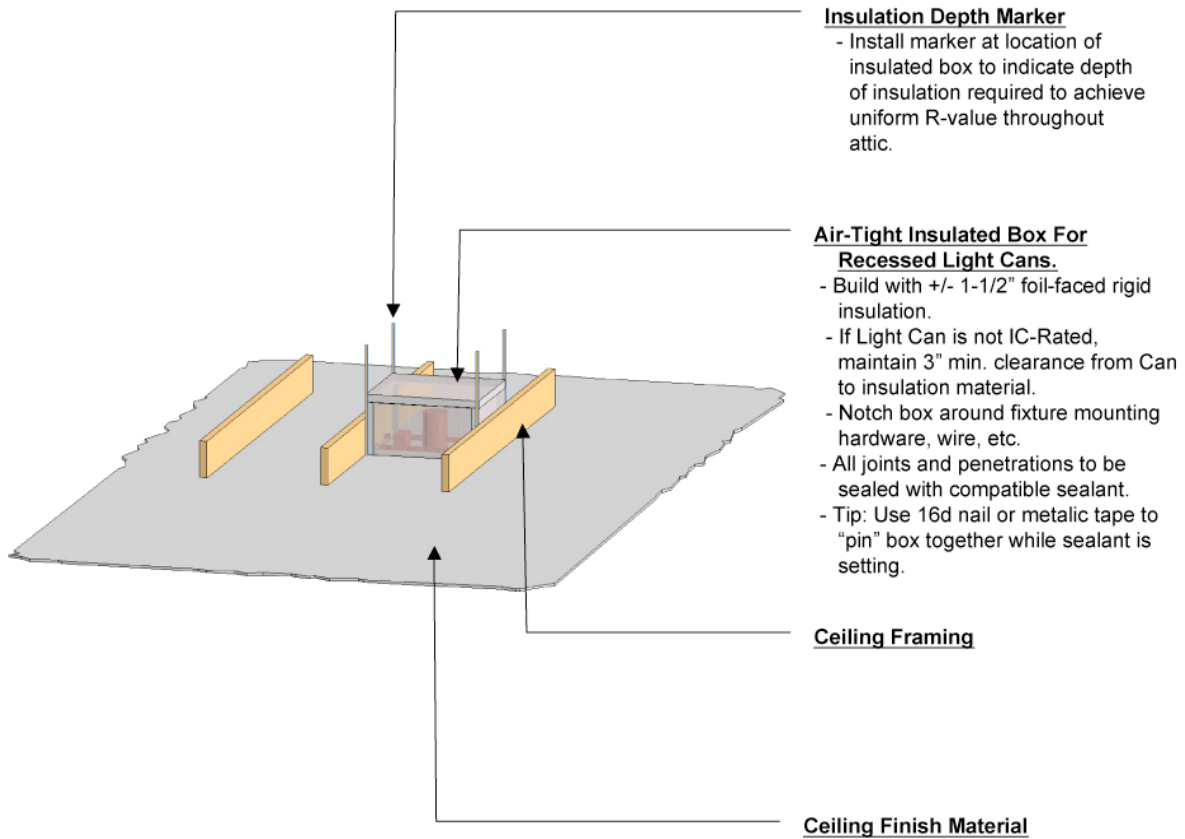

[Thank You Sponsors - Together We Improve Homes & People's Lives](#)

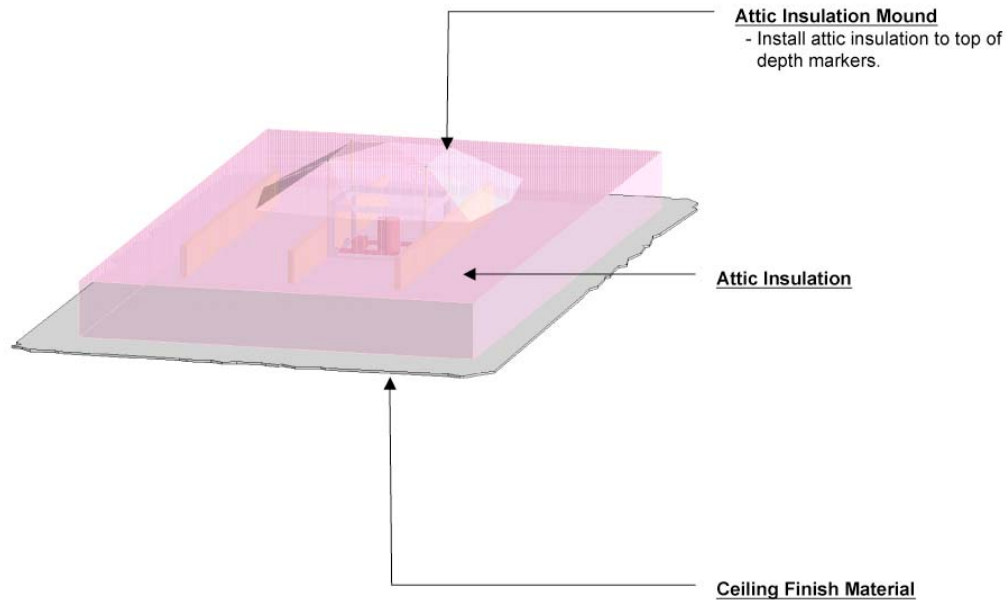

3G-3_ Air barrier on dropped ceiling/soffit is in full contact with insulated framing and any gaps are fully sealed with caulk, foam, or fire-rated sealant

Requirements:

- Notes on drawings and/or specifications indicating work to be done.
- Air barrier (and insulation) should typically be installed before dropped ceilings and soffits are constructed.
- Pre-drywall photo—OR—rater verification

Exceptions:

- None

Rationale:

- Dropped ceilings and soffits are notoriously places where the air barrier is interrupted. Alternately, if it does exist, it is often not in contact with the insulation, as it should be.

Considerations:

- None

Resources:

[Thank You Sponsors - Together We Improve Homes & People's Lives](#)

- TBD

3G-4_ Air barrier in staircase framing adjacent to exterior wall/attic is fully aligned with insulated framing and any gaps are fully sealed with caulk or foam

Requirements:

- Notes on drawings and/or specifications indicating work to be done.
- Air barrier (and insulation) should typically be installed before staircases are constructed adjacent to exterior walls.
- Pre-drywall photo—OR—rater verification

Exceptions:

- Sometimes if closed cell spray foam insulation is used, it is possible to obtain a good thermal, air, and vapor barrier in place after the stair case framing is in place.

Rationale:

- Dropped ceilings and soffits are notoriously places where the air barrier is interrupted. Alternately, if it does exist, it is often not in contact with the insulation, as it should be.

Considerations:

- None

Resources:

- TBD

3G-5_ Air sealing and Insulation improvements to unfinished knee wall areas

Select all that apply:

- 3G-5a_** Walls = R15 to R21 and floors = R38 to R41 (assumes unconditioned knee wall area)—OR—sloped ceiling = R38 to R41 (assumes residually conditioned knee wall area)
- 3G-5b_** Walls = R22 to R29 and floors = R42 to R49 (assumes unconditioned knee wall area)—OR—sloped ceiling = R42 to R49 (assumes residually conditioned knee wall area)
- 3G-5c_** Walls = R30 or more and floors = R50 or more (assumes unconditioned knee wall area)—OR—sloped ceiling = R50 or more (assumes residually conditioned knee wall area)
- 3G-5d_** Use spray-foam to air seal and insulate knee walls and floor—OR—sloped ceiling

[Thank You Sponsors - Together We Improve Homes & People's Lives](#)

Requirements:

- Document existing insulation levels.
- Notes on drawings and/or specifications indicating work to be done.
- If insulating involves open walls or ceilings, then pre-drywall photo of areas insulated—OR—rater verification
- Post-construction photo of areas insulated—OR—rater verification

Exceptions:

- None

Rationale 3G-5a - 3G-5c:

- Important for energy efficiency, durability, and comfort.
- Two main approaches exist for air sealing and insulating the knee wall space.
 1. Air seal and insulate the floor and wall of the knee wall area making the knee wall area unconditioned space
 2. Air seal along the sloped ceiling (roof) of the knee wall area, which means it will receive some residual conditioning from the main living area. Sometimes this is preferred to allow the knee wall area to function as a more frequently used storage space. This might also be preferred if the knee wall space is already being used for storage and already has flooring. It would potentially require more time and effort to remove the flooring, air seal/insulate the floor, and then replace the flooring, than it would be to just insulate the ceiling.

Rationale 3G-5d:

- Spray foam does a better job with air sealing, which improves energy efficiency and indoor environmental quality over other insulation systems.

Considerations:

- None

Resources:

- TBD

3G-5e_ Air seal and insulate critical areas (R30 minimum) (e.g. rim joist at eave, joist cavity under knee wall and cavity at rafter cavity at top of knee wall)

Requirements:

- Pre-construction photo of areas needing improvement. Notes on drawings and/or specifications describing improvements to be done
 - If insulating involves open walls or ceilings, then pre-drywall photo of areas insulated—OR—rater verification
-

[Thank You Sponsors - Together We Improve Homes & People's Lives](#)

- The rim joist at the eave and the rafter cavity at the top of the knee wall need to be air sealed and insulated regardless of the approach taken to improve the knee wall area.
- The joist cavity under the knee wall only needs to be addressed if the Floor and Wall approach is chosen.
- Post-construction photo of areas insulated—OR—rater verification
- Sheathing or blocking must extend down between the flat ceiling joists to seal the floor joist cavities. Sheathing on air impermeable insulation is not required unless mandated by fire code.

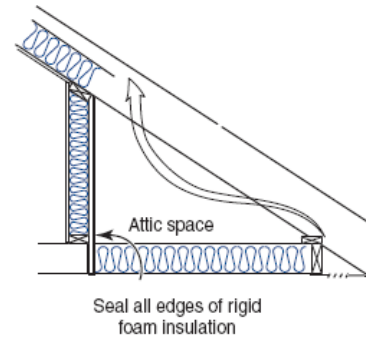
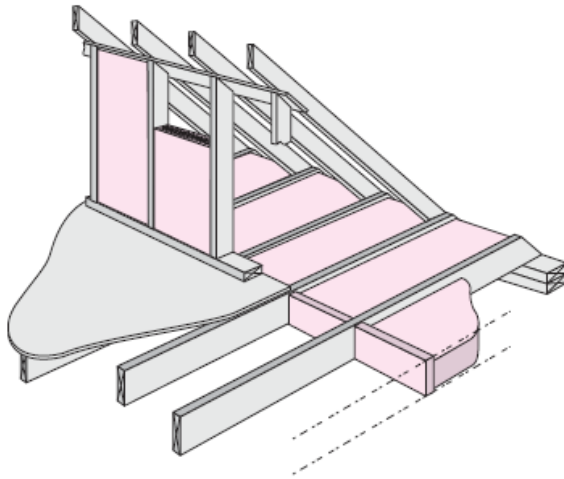

[Thank You Sponsors - Together We Improve Homes & People's Lives](#)

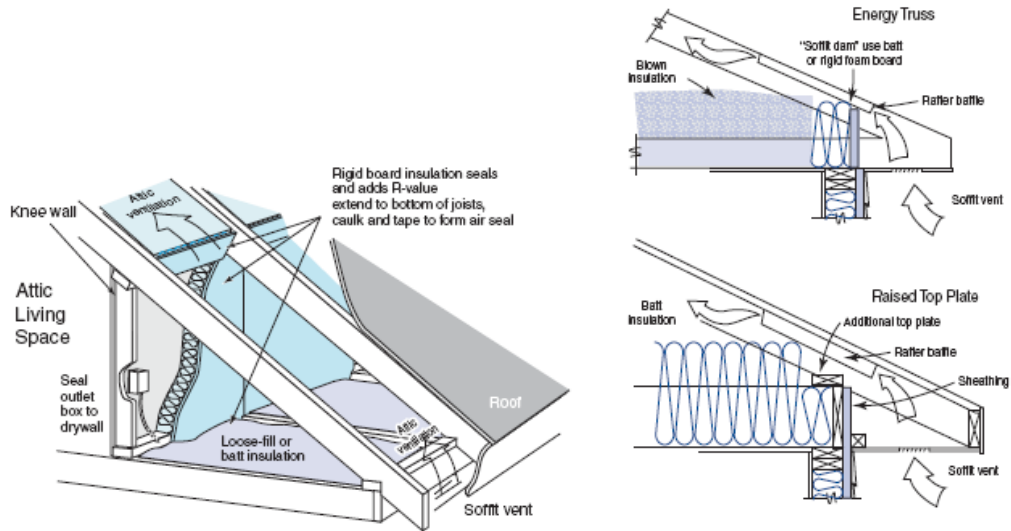

Exceptions:

- None

Rationale:

- Important for energy efficiency, durability, and comfort.

Considerations:

- None

Resources:

- TBD

3G-6_ Improvements to FINISHED vaulted and tray ceilings in living area

Select all that apply:

- 3G-6a_** R25 to R37
- 3G-6b_** R38 to R42
- 3G-6c_** R43 or better
- 3G-6d_** Air seal and insulate sloped roof / ceiling with spray foam.
- 3G-6e_** Add 3/4" minimum foil face polyisocyanurate (or equivalent) insulation to existing sloped roof / ceiling for thermal break and vapor retarder (seal all seams with tape or equivalent)
- 3G-6f_** Install radiant barrier with air space when improving existing finished sloped roof/ceiling system where R38 insulation is not achievable. Radiant barrier on attic floor does NOT qualify.

[Thank You Sponsors - Together We Improve Homes & People's Lives](#)

Requirements:

- Notes on plans or specifications indicating material to be used and/or work to be done.
- Pre-drywall photo—OR—rater verification

Exceptions:

- None

Rationale 3G-4 (general):

- Existing homes frequently have low amounts of insulation at vaulted or tray ceilings. This credit gives incentive to improve the R-value in those areas.

Rationale 3G-6a:

- R25 assumes 3.5” rafter with R6 per inch closed cell spray foam plus R5 rigid (frequently allowed for remodels using hot roof application when finishing attic space. Typically homeowner must sign-off.
- Other combinations of insulation to achieve specified R-Values can also qualify.

Rationale 3G-6b:

- R38 assumes 5.5” rafter with R6 per inch closed cell spray foam plus R5 rigid—Minnesota code minimum for new construction.
- Other combinations of insulation to achieve specified R-Values can also qualify.

Rationale 3G-6c:

- R43 assumes 11-1/8” I-joint rafter with 7/8” air space + 1” (-R6) foil faced rigid, + 2” closed cell spray foam -R12), + 8” high density fiberglass (R25)
- Other combinations of insulation to achieve specified R-Values can also qualify.

Rationale 3G-6d:

- Spray foam does a better job with air sealing, which improves energy efficiency and indoor environmental quality over other insulation systems.

Rationale 3G-6e:

- Foil faced insulation is a Class 1 Vapor Retarder and applying rigid insulation over the face of the rafters helps prevent thermal bridging through the rafters. Foil must face heated side of the room.
- Equivalent insulations should have a minimum Class 2 Vapor Retarder rating and similar R-value.

Rationale 3G-6f:

- Where R38 is not achievable, a properly installed radiant barrier on either the top side and/or the bottom side of the insulation can be beneficial.

[Thank You Sponsors - Together We Improve Homes & People's Lives](#)

- If planning to install a radiant barrier on both top and bottom sides of the insulation, special care must be taken to avoid a vapor trap between them. In this situation, the topside radiant barrier should be vapor permeable and the air space above it should be vented.
- Some of the best radiant barriers, such as aluminum foil are also Class 1 Vapor Retarders unless they are perforated (vapor impermeable).

Considerations:

- Included in Rationale paragraphs above.

Resources:

- TBD

3G-7_ Improve weather-stripping and insulation at EXISTING attic and knee wall access openings (Horizontal Attic Access = R38 min and Vertical Knee Wall Access = R23 minimum). Also applies to new access openings being installed in existing attics or knee walls.

Requirements:

- Notes on drawings and/or specifications indicating work to be done.
- Attic hatch, cover, or door is fully gasketed for an airtight fit.
- Insulation fits snugly and is located to create a continuous thermal barrier in the knee wall or attic ceiling when in place.
- Post-construction photo of access opening—OR—rater verification

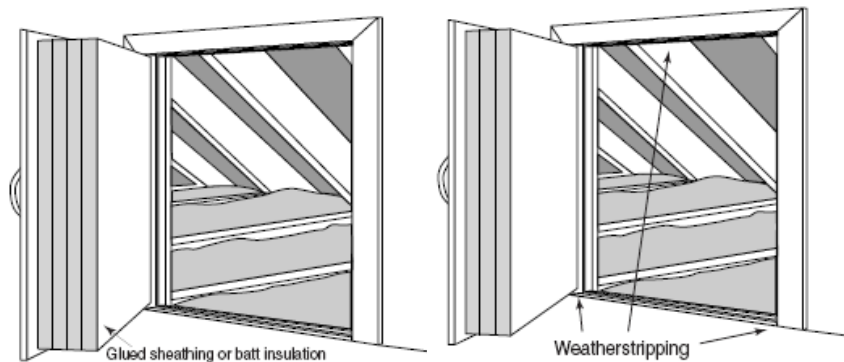

Drawings of vertical knee wall access openings

[Thank You Sponsors - Together We Improve Homes & People's Lives](#)

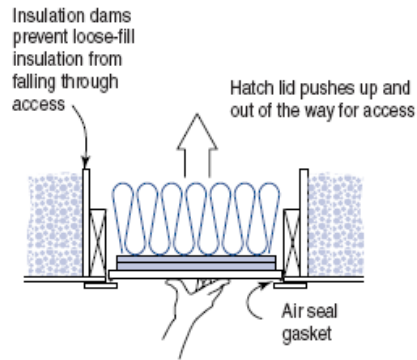

Drawing of horizontal ceiling access opening

Exceptions:

- None

Rationale:

- Air sealing and insulating is extremely important for energy efficiency, durability, and comfort.

Considerations:

- Using fiberglass batts to insulate attic access openings can be problematic. The act of opening and closing the opening can cause small glass fibers to become airborne. These can be irritating and unhealthy.

Resources:

- TBD

3G-8_ 1) Inspect and document existing roof ventilation system (possibly already done if measure 1B-1 was performed). 2) Design and specify venting improvements or conversion to non-vented system. (Projects not needing changes or improvements also qualify.)

Requirements:

- Do documentation and design work as described in credit description above.
- Provide notes on drawings and/or specifications describing work to be done.
- Post-construction photo—OR—rater verification

Exceptions:

- None

[Thank You Sponsors - Together We Improve Homes & People's Lives](#)

Rationale:

- If a vented roof is part of the overall design of the house, then it must be balanced and working properly.
- Most houses are designed to have a vented roof. Usually it is a passive system, but occasionally there is one that is mechanically vented. Regardless of the type, it is very common to find them not operating as they should. Many times the proper vent holes were not installed from the beginning. If they do exist, they have often become blocked over time from dust and dirt or carelessly installed insulation.
- If roof ventilation is not working properly, the effects include the following.
 - Damage to the building structure
 - Water leaking through the ceiling of upper rooms
 - Wet attic insulation, which has very little R-value, and keeps the structure wet, which makes structural decay progress more rapidly.

Considerations:

- See Rationale above.

Resources:

- TBD - See calculator spreadsheet for balanced roof attic ventilation in checklist.

3G-9_ Implement design from 3G-8. Install-new and/or improve-existing eave vents, vent chutes, roof vents—OR—Convert to non-vented. (Non-vented designs must be pre-approved by building code official.) (Projects not needing changes or improvements also qualify.)

Requirements:

- Perform work described in design/specification portion of credit 3G-8.
- Post-construction photo—OR—rater verification

Exceptions:

- None

Rationale:

- See 3E-8

Considerations:

- See 3E-8

Resources:

3G-10_ Existing roof improved w/ Advanced Roofing Materials & Techniques.

[Thank You Sponsors - Together We Improve Homes & People's Lives](#)

Select all that apply:

- 3G-10a_ Self sealing bituminous membrane at valleys and penetrations (code required at eaves)
- 3G-10b_ Self sealing bituminous membrane over entire roof deck
- 3G-10c_ Metal drip edge at all roof edges
- 3G-10d_ Metal "W" shaped valley flashing at valleys
- 3G-10e_ Minimum 40-year roofing material (minimum 90% of roof area)
- 3G-10f_ Minimum 50-year roofing material (minimum 90% of roof area)
- 3G-10g_ Lifetime roofing material (including slate, steel, concrete, clay, etc.) (minimum 90% of roof area)
- 3G-10h_ Roofing material with ENERGY STAR Cool Roof certification (90% minimum of roof area)
- 3G-10i_ Green roof system is installed (see Rainwater Management)

Requirements:

- Notes on drawings and/or specifications indicating work to be done or product to use.
- Post-installation photo—OR—rater verification

Exceptions:

- None

Rationale:

- 3G -10a and 3G -10b. Self-adhesive bituminous membrane is an excellent water barrier, which can seal around fasteners that puncture it. It is an upgrade from the more common 30# building paper. Always assume that water and moisture will get past the primary roofing material as some point, therefore, a good drainage plane is important.
- 3G -10c. Metal drip edge
 - Helps ensure that water drips clear of the roof rather than running down the face of the roof fascia and trim.
 - Drainage plane above shall direct water flow onto and not behind flashing.
- At roof/sidewall locations, the intersecting wall siding shall terminate a minimum of 2" above roof.
- 3G -10d. Metal "W" shaped valley flashing is more durable than just weaving shingles down the valley. Also, the ridge in the middle helps ensure that water from one side of the valley does not cross the valley and go up under the roofing on the opposing side.

[Thank You Sponsors - Together We Improve Homes & People's Lives](#)

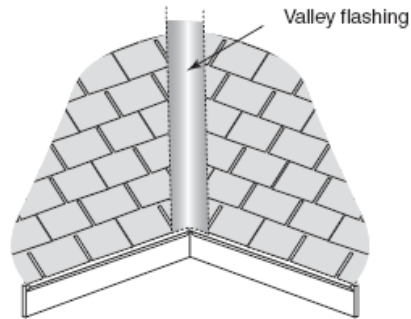

- 3G -10e to 4E - 10g. Longer warranties and longer life expectancy implies greater durability.
- 3G -10h. Roofing that has the ENERGY STAR Cool Roof certification will stay cooler, and therefore contribute less to summer cooling requirements in the house. This effect is more pronounced in climates where lower insulation R-values are common, but it still has a slight benefit in Minnesota.
- 3G-10i. See Rainwater Management section for more information.
 - Must follow manufacturer's specifications for installation.
 - A structural engineer must review vegetated roof design and field verify site conditions prior to, and after installation.
 - A vegetated roof reduces solar heat gain on a roof as the plant material absorbs heat as well as aids in minimizing roof water runoff.

Considerations:

- None

Resources:

- TBD

[Thank You Sponsors - Together We Improve Homes & People's Lives](#)

4 New Floor, Wall, Ceiling & Roof Assemblies

Section 4 covers all NEW floor, wall, ceiling and roof assemblies being added to a house, not just those which make up the Building Envelope. New additions allow for the opportunity to control the whole construction process, whereas modifying existing structures to be better suited to our environment is more difficult. When designing new space (e.g., additions) consider designs that work with actual material size modules or increments, rather than random sizes. For example, work with full sheets of sheathing or drywall and stud lengths, and locate window and door openings within stud bays. This strategic approach will lead to less job site waste, and less time cutting and trimming materials to fit. If the project is designed on this type of a material module, look to the Innovation section to earn additional credits.

4PR - Prerequisites

4PR-1_ Finishing a basement can be risky. If choosing to finish a basement anyway, indicate how bulk water and water vapor will be managed by the proposed design.

Requirements:

1. Document bulk water intrusion risk, indicate any protection being planned.
2. Document proposed drying mechanism for walls and floor.
3. Perform Calcium Chloride Measured Vapor Emission Rate (MVER) test on floor - ASTM F 1869-04. (See also Exceptions Below)
 - Perform a minimum of three (3) tests for the first 1,000 square feet and an additional test for every 1,000 square feet beyond.
 - Test results must be 3 lbs. or less of moisture per 1,000 square feet of area in 24 hours.
 - Install a barrier membrane if more than 3 lbs.
 - Installation specifications for the flooring being installed will have different moisture (MVER) tolerances.

Exceptions:

- Calcium Chloride Test is NOT required for GreenStar when new slab is being installed AND new slab has proper vapor retarder installed below it.
Note: If finish material is being added to a new slab, the Calcium Chloride Test MAY still be required by the manufacturer of the finish material. Verify with manufacturer & installer.

Rationale:

Insulating and/or finishing a basement are heavily debated issues from the Green building perspective.

[Thank You Sponsors - Together We Improve Homes & People's Lives](#)

It is very risky if the intention is to finish the basement as living space, if AT LEAST one of the following systems does NOT exist:

1. Exterior bulk water management system consisting of foundation waterproofing and footing drain tile –OR– exterior drainage plane and drain tile.
2. Interior bulk water management system consisting of drainage plane on wall, which allows drainage into drain tile with filter fabric under slab, sump pump, and sub-slab soil gas ventilation system.

On the positive side, it is very Green to improve the energy efficiency of this area of the house that is typically not very well insulated or airtight. Also, finishing a basement falls into the Green strategy of increasing living space in a house without increasing the footprint or volume of the house.

The potentially negative side of finishing a basement has to do with the potentially harmful indoor environmental situation that can arise if bulk water and water vapor are not managed well with regard to how the floor, wall, and ceiling assemblies are designed, and the properties of the materials used in them.

If these issues seemed challenging on above-grade walls, basements take this challenge to an even a greater level. They should be addressed with great care, and consulting with a knowledgeable professional is highly recommended!

The following are some assumptions about basements in Minnesota that should always be addressed when insulating or finishing a basement.

- Bulk water will make its way through the wall at some point in the life of the foundation. A good exterior bulk water management system can make this less likely, but if the inside is being finished, designing the inside of the wall to accommodate bulk water if and when it ever does is the prudently safe approach to take.
- Moisture levels can fluctuate greatly. The MVER test is a good way to determine if the slab is dry at a particular time, but that could change if a proper bulk water management system is not in place and weather is rainy for a period of time. Also, it may appear as though no bulk water ever comes through the walls, but that could also change if there is a water leak such as a garden hose left running near the foundation and saturates the outside of the foundation in a way that had not happened prior.
- Radon levels can fluctuate over time as well. Cracks in the floor slab or foundation wall that are common over time, can let more radon in. Also radon seepage through the soil under or to the side of the foundation can change as well.

[Thank You Sponsors - Together We Improve Homes & People's Lives](#)

Taking care to understand the risks of finishing a basement cannot be emphasized enough.

Considerations:

- Explained in Rationale paragraphs above.

Resources:

- See Basement Risk Assessment Worksheet in Checklist or from GreenStar.
- Hiring a Rater to perform this assessment may be a good idea if others on the design team are not qualified to perform this assessment.
- TBD (perhaps add some drawings of recommended foundation wall sections as described above.)

4PR-2_ Use Integrated Pest Management (IPM) methods to exclude pest entry

- [See 3PR - 2](#)

4PR-3_ Structural plywood conforming to PS1 and PS2 and oriented strand board (OSB) shall be made with exterior-type adhesives

- [See 3PR - 3](#)

4PR-4_ All new attached garages must be built with breezeway/mudroom and other measures to minimize the potential for garage pollution to enter the house

- [See 3PR - 4](#)

4PR-5_ NOT USED

- [See 3PR - 5](#)

4PR-6_ If recessed light fixtures are being added or replaced where they penetrate into the unconditioned area of the attic, then new fixtures must be installed to prevent air and thermal leakage

- [See 3PR - 6](#)
-

[Thank You Sponsors - Together We Improve Homes & People's Lives](#)

4PR-7_ Any new installation of salvaged doors or windows in an exterior application must be weather-stripped, or air sealed with appropriate gasket

- [See 3PR - 7](#)

4PR-8_ All new connecting doors between living space and attached garage are gasketed or made substantially airtight with weather stripping and an automatic closer

- [See 3PR - 8](#)

4PR-9_ No power roof vents unless adequate air inlets exist

- [See 3PR - 9](#)

4PR-10_ Insulation product info. sheet showing R-Value.

- [See 3PR - 10](#)

4PR-11_ All insulation used must be formaldehyde free

- [See 3PR - 11](#)

4A - Air Tightness

An energy efficient home shall be built as airtight as possible and ventilated properly. An excellent air barrier is one of the most important elements of a high performance envelope assembly. See also Introduction to Sections 3 and 4 - Air Barriers and Vapor Barriers (Retarders). See Subsection 3A

4B - New Foundations, Crawl Spaces, and Slab Floor Assemblies

[Thank You Sponsors - Together We Improve Homes & People's Lives](#)

4B-PR1_ Install soil gas (a.k.a. radon) mitigation system in new basements and new crawl spaces

Requirements:

- Install perforated drain tile under slab or localized pocket filled with granular material.
- Install solid 4" ABS vent pipe from foundation drain tile or localized pocket of granular fill through roof. Do not install vent pipe within exterior walls of the house. Install plumbing penetration boot on roof to prevent water leakage at roof penetration.
- All pipe connections and penetrations through the basement slab to be airtight.
- Test lowest inhabitable area of house for radon at the beginning of occupancy using qualified test kit. Both a 48-hour test and a 90-day test are acceptable. Levels must be below 4 picocuries.
- If dangerous levels of radon are present (more than 4 picocuries per liter), install continuously operating, in-line fan in vent pipe.
- Retest
- If dangerous levels of radon still exist, contact radon mitigation specialist.
- Supply homeowner with a copy of the test results.

Exceptions:

- None

Rationale:

- Opportunities to stop radon gas from entering the living space or future living space must be taken to ensure the health of occupants.
- Installing a soil gas vent system, regardless of radon levels, is inexpensive when working within a new space.
- Radon levels can fluctuate greatly over the life of the home.
- In addition to mitigating radon risks, soil gas vents also help reduce sub-slab moisture levels, which contributes to a healthier basement environment as well

Considerations:

- None

Resources:

- TBD

4B-PR2_ Remember basement risk assessment and Calcium Chloride Test before finishing basement. See 4PR - 1 for more details.

[Thank You Sponsors - Together We Improve Homes & People's Lives](#)

Requirements:

- [See 4PR - 1](#)

Exceptions:

- [See 4PR - 1](#)

Rationale:

- [See 4PR - 1](#)

Considerations:

- [See 4PR - 1](#)

Resources:

- TBD

4B-PR3_ Crawl spaces shall be conditioned (raised pier foundation with no foundation walls is exempt)

Requirements:

- Crawl space is provided with supply air at a rate no less than 0.02 cfm per square foot of horizontal area and equal size exhaust opening to the conditioned space.
- Air seal and insulate crawl space walls, and insulate rim joists to code (minimum requirement - see additional credits for beyond-code insulation and air sealing).

Exceptions:

- Structures supported on raised pier foundations.

Rationale:

A conditioned crawl space has the following benefits.

- Reduced risk of mold since it stays drier
- Allows for air supply and return ducts to be free of insulation.
- Mechanical and electrical systems and the building structure itself are easier to maintain and modify in the future when the crawl space is conditioned.
- It increases the comfort of the room above,
- EEBA Water Management Guide and EEBA Climate Specific Builder's Guide for crawl spaces.

Considerations:

- None

Resources:

[Thank You Sponsors - Together We Improve Homes & People's Lives](#)

- EEBA Water Management Guide and EEBA Climate Specific Builder's Guide for crawl spaces.

4B-PR4_ Properly install Class 1 or 2 Vapor Retarder on top of basement and/or crawl space soil or gravel

Requirements:

- Install vapor barrier and seal to foundation wall and penetrations
- 100% coverage is mandatory.

Exceptions:

- None

Rationale:

- Prevents bulk water, water vapor and other soil gasses from entering living space or interior finish systems.
- Prevents moisture and soil gasses from leaking into basement or crawl space through slab.

Considerations:

- None

Resources:

- TBD

4B-1_ Install 4" bed of 3/4" diameter or greater clean or washed gravel on top of basement and/or crawl space soil before any other flooring work is done

Requirements:

- A minimum 4" deep gravel bed shall be installed beneath all concrete floor slabs. If plastic vapor barrier is installed, plastic must be on top of gravel.
- Notes on drawings and/or specifications indicating work to be done or product to use.
- Post-installation photo—OR—rater verification

Exceptions:

- None

Rationale:

- Provides capillary break and drainage medium for water, water vapor, and other gasses.

[Thank You Sponsors - Together We Improve Homes & People's Lives](#)

Considerations:

- No sand allowed
- Only if existing soil is not free-draining or gravel.

Resources:

- TBD

4B-2_ Recycled concrete, asphalt or glass for base or fill

Requirements:

- Verify the aggregate size is appropriate for the intended use.
- Verify with structural engineer before using any reused materials in poured concrete that has critical structural functions including foundation walls and footings.
- Notes on drawings and/or specifications indicating product to be used.
- Invoice—OR—letter indicating type and source of recycled material

Exceptions:

- None

Rationale:

- Efficient reuse of materials that are commonly put in landfill

Considerations:

- None

Resources:

- TBD

4B-3_ Insulation for new floor slabs

Select one:

- 4B-3a_ R-5 rigid insulation at edge and under entire basement floating floor slab (assumes NO in-floor radiant heat)
- 4B-3b_ R-10 rigid insulation at edge and under entire basement OR on grade floating floor slab (see manual for Exceptions)
- 4B-3c_ R-15 rigid insulation at edge and under entire basement OR on grade floating floor slab (suitable for in-floor radiant heat) (see manual for Exceptions)

Requirements:

[Thank You Sponsors - Together We Improve Homes & People's Lives](#)

- Insulate slab to as indicated with rigid insulation by a code-approved assembly including a minimum continuous 6 mil poly sheeting between insulation and slab.
- Notes on drawings and/or specifications indicating work to be done or product to use.
- Post-installation photo—OR—rater verification

Exceptions:

- If closed cell spray foam is used, 6 mil poly can be omitted.
- For ICF foundations, additional slab edge insulation can be adjusted according to the R-value of the ICF wall insulation for total slab edge R-value. Normal under-slab insulation still applicable as specified in credit language above.

Rationale:

- Insulating the slab conserves energy for heating and gives greater thermal comfort under foot.
- Slabs lose energy primarily as a result of heat conducted outward and through the perimeter of the slab, rather than evenly downward through the slab.
- Insulating the edge and perimeter of the slab is almost always an effective measure and very cost effective strategy.
- Insulating under the middle area of the slab is also helpful, but in some instances it may be better to leave it out.

Examples:

- If the slab is going to be heated continuously throughout the heating season, leaving the insulation out of the center area of the slab allows the ground under the slab to act as greater thermal mass and actually improve the overall system performance.
- If the slab is going to be heated intermittently (e.g., cabin) then full insulation is better, and in fact, at some point, if the heating is very intermittent, a high mass in-floor system is a poor choice all together.
 - The best overall slab insulation strategy that is used is somewhat dependent on the overall house design and heating strategy.

4B-3a No In-floor heat. Minimal rigid insulation being added for moderate energy efficiency and increased comfort.

4B-3b Floor with or without in-floor heat. If high thermal mass floor is beneficial (i.e., floor is to be heated continuously during heating season and fast temperature response time is not necessary) then insulate only 8' width under slab at perimeter.

4B-3c Floor with or without in-floor heat. If high thermal mass floor is beneficial (i.e., floor is to be heated continuously during heating season and fast temperature response time is not necessary) then insulate only 8' width under slab at perimeter.

[Thank You Sponsors - Together We Improve Homes & People's Lives](#)

- Low thermal mass radiant heat applications are best in situations where the heating system needs a fast response time (e.g., cabins or other spaces that are not intended to be heated continuously throughout the heating season). In these situations, installing the heat tubes in something other than concrete may be worth considering.

Considerations:

- Getting the assistance of a knowledgeable HVAC system designer is recommended.

Resources:

- TBD

4B-4_ Exterior foundation insulation

NOTE: MN Rules Chapter 1322 (MN Residential Energy Code as of June 1, 2009) is very specific about foundation insulation, vapor retarders and waterproofing for new foundation walls.

- **Having anything other than R10 for insulation on new foundation walls will most likely require special sign off by a professional engineer.**
- **Installing the proper vapor retarder and/or waterproofing in the proper location is required or sign off by a professional engineer is required.**

Select One:

- 4B-4a_** R-15 continuous exterior foundation insulation. Top of foundation to top of footing or frost depth, which ever is greater).
- 4B-4b_** R-20 continuous exterior foundation insulation. Top of foundation to top of footing or frost depth, which ever is greater).
- 4B-4c_** R-25 continuous exterior foundation insulation. Top of foundation to top of footing or frost depth, which ever is greater).

Requirements:

- Notes on drawings and/or specifications indicating work to be done or product to use.
- Post-installation photo—OR—rater verification

Exceptions:

- If closed cell spray foam is used, 6 mil poly can be omitted.

Rationale:

- Reduces the potential for heat loss, condensation and corresponding growth of mold, and increases the livability of below-grade rooms.
- Helps protect below grade waterproofing.
- Insulating the exterior of the foundation is typically thought to be the best way to insulate a foundation wall.

[Thank You Sponsors - Together We Improve Homes & People's Lives](#)

Considerations:

- See important note above.

Resources:

- TBD

4B-5_ Take measures to minimize and control cracking in interior concrete slabs. Install reinforcing AND provide control joints at proper locations

Requirements:

- Install reinforcing as stated in credit language above. Some acceptable types include Welded Wire Fabric (WWF), rebar, and fiber reinforced concrete.
- Install control joints at proper locations.
- Notes on drawings and/or specifications indicating work to be done or product to use.
- Post-installation photo—OR—rater verification

Exceptions:

- None

Rationale:

- Helps improve durability of other materials installed on top of the concrete.

Considerations:

- None

Resources:

- Control joint layout guide. See also:
- www.concretenetwork.com/concrete/slabs/controljoints.htm
- Be active in deciding where control joints will be placed.
- Control joints are planned for cracks, which allow for movements caused by temperature changes and drying shrinkage. In other words, if the concrete does crack, you'll want to play an active role in deciding where it will crack and that it will crack in a straight line instead of randomly.
- Space joints properly. Space joints (in feet) no more than 2-3 times the slab thickness (in inches). A 4" slab should have joints 8-12' apart.
- Cut joints. Grooving tools cut joints in fresh concrete. Saw cutting cuts joints as soon as the concrete is hard
- enough that the edges abutting the cut do not chip from the saw blade.
- Cut joints deep enough. Cut joints 25% of the depth of the slab. A 4" thick slab should have joints 1" deep.

[Thank You Sponsors - Together We Improve Homes & People's Lives](#)

- Cut joints soon enough. In hot weather, concrete might crack if joints are not cut within 6-12 hours after finishing concrete. In this condition, if you don't want to use a grooving tool to cut joints, there are early-entry dry-cut lightweight saws that can be used almost immediately after finishing. These saws cut 1" to 3" deep, depending on the model.
- Place joints under walls or other areas where they will not be seen.

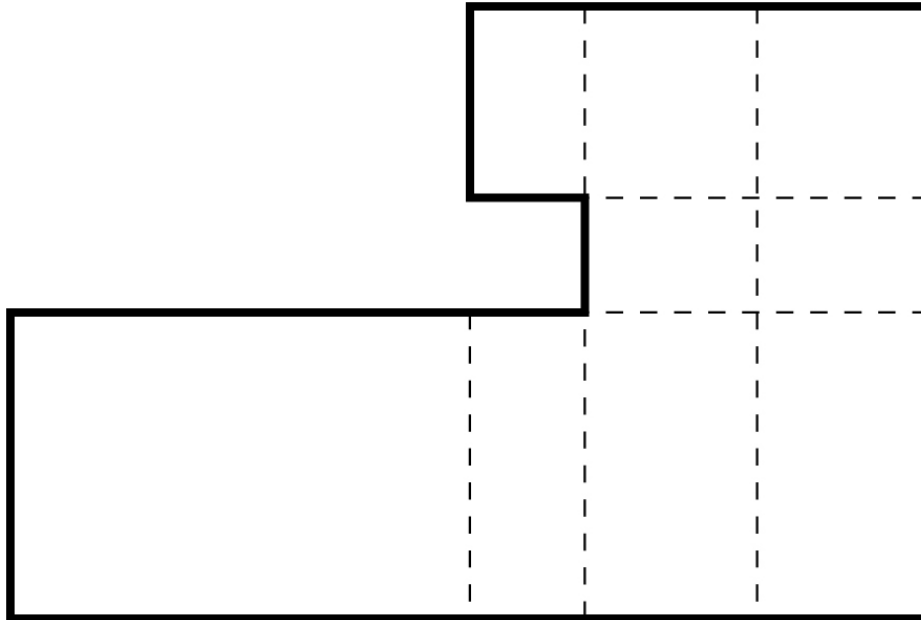

4B-6_ Concrete with fly ash is used (minimum 25% fly ash)

Requirements:

- Replace a minimum of 25% of the Portland cement in all concrete used for footings, foundation and basement walls, and slabs with fly ash or slag.
- CMU manufactured with fly ash may also qualify if percentage is met.
- Verify with structural engineer to determine that the amount of fly ash specified for the concrete is acceptable for the intended use and required strength.
- Notes on drawings and/or specifications indicating fly ash to be used.
- Documentation from concrete manufacturer indicating fly ash content.

Exceptions:

- None

Rationale:

[Thank You Sponsors - Together We Improve Homes & People's Lives](#)

- Efficient use of by-product primarily produced by burning coal.
- Fly ash strengthens concrete
- Fly ash also increases the R-value of concrete.

Considerations:

- Fly ash can prolong the curing time of concrete, but this can be partially offset by the fact that lesser amounts of water can be used since it also improves the workability of the concrete.
- Different classes of fly ash are produced from burning different types of coal. Class C and Class F are common, but Class C is more likely to be available in Minnesota.
- Depending on the type of fly ash used, where concrete will be exposed to freeze-thaw cycles, fly ash concentration may be limited to 56% or less and/or air entrainment chemicals may need to be increased since fly ash partially negates the effectiveness of them.
- In certain applications, Class C fly ash can replace up to 100% of cement in concrete.

Resources:

- Environmental Building News, The Fly Ash Revolution: □ Making Better Concrete with Less Cement

4B-7_ Low toxicity form release agents used on concrete form work

Requirements:

- Notes on drawings and/or specifications indicating product to be used.
- Manufacturer specifications for form release agent

Exceptions:

- None

Rationale:

- Better for workers and less likely to harm indoor environmental quality.

Considerations:

- None

Resources:

- Typically water-based and/or soy-derived formulations qualify.

4B-8_ Reusable foundation forms are used

Requirements:

[Thank You Sponsors - Together We Improve Homes & People's Lives](#)

- Notes on drawings and/or specifications indicating forms to be used.
- Photo of forms being used—OR—rater verification

Exceptions:

- None

Rationale:

- Reusing foundation forms again and again keeps regularly used materials out of the landfills
- Use aluminum, steel, or other durable foundation forms

Considerations:

- None

Resources:

- TBD

4B-9_ Install 4" minimum perforated foundation drain with 3/4" gravel and filter fabric at OUTSIDE perimeter of new footings

Requirements:

- Drain to daylight or interior sump pump.
- Top of tile to be below bottom of basement slab.
- Surround pipe with minimum 6" of 3/4" washed or clean gravel that is fully wrapped with geo-textile fabric. All drain lines shall be connected and exited downhill from the foundation—OR—drain into sealed sump basket with pump
- Notes on drawings and/or specifications indicating work to be done or product to use.
- Post-installation photo—OR—rater verification

Exceptions:

- None

Rationale:

- Removes bulk water and helps remove water vapor and soil gases if attached to soil gas vent pipe.

Considerations:

- Rigid drain systems are preferred over compressible foundation drains, as the long-term quality of the compressible drains is unknown, especially after backfill has been installed.
 - If draining to daylight, a proper screen or cap must be installed at end of pipe to prevent rodents from entering drainpipe.
-

[Thank You Sponsors - Together We Improve Homes & People's Lives](#)

Resources:

- TBD

4B-10_ Install 4" minimum perforated foundation drain with 3/4" gravel and filter fabric at INSIDE perimeter of new footings

Requirements:

- Drain to interior sump pump.
- Top of tile to be below bottom of basement slab. Pipe shall be surrounded with minimum 6" of 3/4" washed or clean gravel that is fully wrapped with geo-textile fabric.
- Notes on drawings and/or specifications indicating work to be done or product to use.
- Post-installation photo—OR—rater verification

Exceptions:

- None

Rationale:

- Removes bulk water and helps remove water vapor and soil gases if attached to vent pipe.

Considerations:

- Rigid drain systems are preferred over compressible foundation drains, as the long-term quality of the compressible drains is unknown, especially after backfill has been installed.

Resources:

- TBD

4B-11_ Frost protected shallow foundation (may not be used in connection with other types of foundations (see also IRC Code) (R403.3)

Requirements:

- Design addition using frost protected shallow foundation system.
- Notes on drawings and/or specifications indicating work to be done or product to use.
- Post-installation photo—OR—rater verification
- Must tie into home with a type of footing.

Exceptions:

- None

[Thank You Sponsors - Together We Improve Homes & People's Lives](#)

Rationale:

- Less excavating and material for foundation

Considerations:

- For connection to structures with pre-existing frost protected shallow foundation only.
- Cannot be connected to any other type of footing.

Resources:

- International Residential Code (IRC)
- Frost Protected Shallow Foundation Design Specifications:
www.buildingfoundation.umn.edu/MHFAfrostFoundation.htm

4B-12_ Provide capillary breaks 1) between top of footings and bottom of foundation wall, 2) below slabs, and 3) where cementitious products connect to framing material (e.g., garage floors, stoops, and porches)

Requirements:

- Install a capillary break between concrete foundation wall and sill plate. Only membranes that are Class 1 or 2 Vapor Retarders are acceptable.
- Sill gaskets (a.k.a. sill sealers) separating wall sill plates from concrete must be the full width of the wall sill plate.
- Notes on drawings and/or specifications indicating work to be done or product to use.
- Post-installation photo—OR—rater verification

Exceptions:

- None

Rationale:

- Cementitious products like concrete and masonry are like a sponge. They will absorb and wick water internally due to capillary action. This means water can move up a concrete structure against the force of gravity.
- Capillary movement of water through footings and up the foundation wall is commonly overlooked.

Considerations:

- None

Resources:

- TBD - perhaps add diagrams or drawings in future.

[Thank You Sponsors - Together We Improve Homes & People's Lives](#)

4B-13_ Install Ufer Ground that does NOT contribute to widespread Electro Magnetic Fields (EMF) in home

Select one:

4B-13a_ Install dedicated steel #4 rebar ground rod embedded in concrete footing and stubbed out for connection to electrical panel ground wire. 20' minimum rebar length and CANNOT touch other rebar.

(See 11B-2 for points and requirements)

4B-13b_ Install dedicated steel #4 rebar grounding rod embedded in separate concrete caisson and stubbed out for connection to electrical panel ground wire. 20' minimum rebar length.

(See 11B-2 for points and requirements)

4B-14_ Insulated concrete forms (ICF) or insulated concrete “T” Wall or equivalent system is used with a minimum of R14

NOTE: MN Rules Chapter 1322 (MN Residential Energy Code as of June 1, 2009) is very specific about foundation insulation, vapor retarders and waterproofing for new foundation walls.

- **Having anything other than R10 for insulation on new foundation walls will most likely require special sign off by a professional engineer.**
- **Installing the proper vapor retarder and/or waterproofing in the proper location is required or sign off by a professional engineer is required.**

Requirements:

- Must provide insulation for a minimum 90% of foundation or exterior walls.
- Walls shall be installed according to manufacturer’s specifications.
- Notes on drawings and/or specifications indicating work to be done or product to use.
- Post-installation photo—OR—rater verification

Exceptions:

- None

Rationale:

- Insulated concrete forms allow for continuous insulation inside as well as outside the building envelope for the excellent insulating effect.
- Considerations:
- If Thermo Mass T-Mass walls are used as the finish surface, Resource Efficiency points may be granted through the Section 11 - Innovation.

Resources:

- TBD

[Thank You Sponsors - Together We Improve Homes & People’s Lives](#)

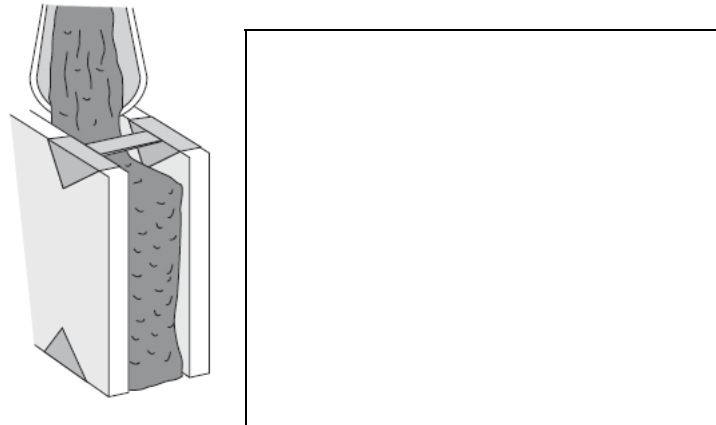

4B-15_ Insulated pre-cast concrete foundation system is used with minimum R10 Insulation

NOTE: MN Rules Chapter 1322 (MN Residential Energy Code as of June 1, 2009) is very specific about foundation insulation, vapor retarders and waterproofing for new foundation walls.

- Having anything other than R10 for insulation on new foundation walls will most likely require special sign off by a professional engineer.
- Installing the proper vapor retarder and/or waterproofing in the proper location is required or sign off by a professional engineer is required.

Requirements:

- Must provide insulation for a minimum 90% of foundation or exterior walls.
- Notes on drawings and/or specifications indicating work to be done or product to use.
- Post-installation photo—OR—rater verification

Exceptions:

- None

Rationale:

- Resource efficient and durable foundation system.
- Often times a gravel-only footing can be used with this system.

Considerations:

- None

Resources:

[Thank Yo](#)

[Improve Homes & People's Lives](#)

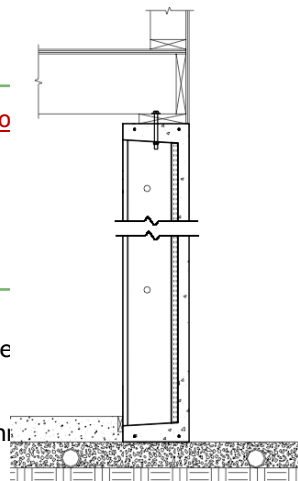

- TBD

Example of pre-cast foundation

4B-16_ Foundation walls are solid concrete—OR—CMU wall with top course of filled cores, solid block or bond beam

Requirements:

- Notes on drawings and/or specifications indicating work to be done or product to use.
- Post-installation photo—OR—rater verification

Exceptions:

- None

Rationale:

- Basically this credit is to give incentive to NOT leave CMU cores open at the top.
- Open CMU cores can contribute to problems with high moisture content in the rim joist assembly above them.

Considerations:

- None

Resources:

- TBD

4B-17_ Use reclaimed material for foundation (e.g., reclaimed CMU)

[Thank You Sponsors - Together We Improve Homes & People's Lives](#)

Select one:

- 4B-17a_ 30% to 49%
- 4B-17b_ 50% to 89%
- 4B-17c_ 90% or more

Requirements:

- Notes on drawings and/or specifications indicating work to be done or product to use.
- Invoice—OR—letter indicating source of reclaimed product.

Exceptions:

- None

Rationale:

- Use of reclaimed materials always contributes to a very efficient use of materials overall.

Considerations:

- Care must be taken to ensure that reclaimed materials are still structurally sound.

Resources:

- TBD

4B-18_ Water based waterproofing system

Requirements:

- Install waterproofing on exterior of foundation continuous from top of grade to bottom of footing.
- Notes on drawings and/or specifications indicating work to be done or product to use.
- Post-installation photo—OR—rater verification

Exceptions:

- None

Rationale:

- Water based products typically have less harmful effects on the environment in their life cycle than asphalt based products.

Considerations:

- None

Resources:

[Thank You Sponsors - Together We Improve Homes & People's Lives](#)

- TBD

4B-19_ Install material which protects waterproof membrane and functions as a hydrostatic pressure release

Requirements:

- Must be used with an exterior perforated footing drain tile.
- Notes on drawings and/or specifications indicating work to be done or product to use.
- Post-installation photo—OR—rater verification

Exceptions:

- None

Rationale:

- Protects waterproof membrane from becoming damaged.
- Allows water to run off the surface of foundation without penetrating the waterproof membrane
- The hydrostatic pressure release material usually has a texture to it which allows gravity to pull bulk water down to foundation drain before it has a chance to build up pressure against the water proof membrane.
- Dimpled sheeting is considered a hydrostatic pressure release.

Considerations:

- None

Resources:

- Dimpled sheeting qualifies.
- Some thick fiberglass boards qualify and are designed to also provide added insulation value.
- Rigid insulation does NOT qualify unless specifically designed for this purpose.

4B-20_ Foundation walls, not covered with masonry veneer cladding, are capped with sun interrupted termite sheet metal, plastic or equivalent termite shield that extends a minimum of 1/2" beyond the interior and exterior sides of the wall, before installation of the sill plate

Requirements:

- Notes on drawings and/or specifications indicating work to be done or product to use.
- Post-installation photo—OR—rater verification

Exceptions:

[Thank You Sponsors - Together We Improve Homes & People's Lives](#)

- None

Rationale:

- Largely due to recent winters being fairly mild, termites appear to be migrating north into the southern areas of Minnesota.

Considerations:

- None

Resources:

- TBD

4B-21_ Install vapor impermeable, dimpled sheeting continuous from under slab to top of foundation wall. Seal all edges.

NOTE: MN Rules Chapter 1322 (MN Residential Energy Code as of June 1, 2009) is very specific about foundation insulation, vapor retarders and waterproofing for new foundation walls.

- **Having anything other than R10 for insulation on new foundation walls will most likely require special sign off by a professional engineer.**
- **Installing the proper vapor retarder and/or waterproofing in the proper location is required or sign off by a professional engineer is required.**

Requirements:

- Notes on drawings and/or specifications indicating work to be done or product to use.
- Post-installation photo—OR—rater verification

Exceptions:

- None

Rationale:

- Extra protection against bulk water leaks in the foundation, in the event that the exterior waterproofing fails.
- Even when exterior waterproofing exists, additional protection on the interior against bulk water leaks can be money well spent.
- Serves as an interior vapor barrier, while maintaining an air space at the surface of the interior of the foundation wall, which allows the foundation wall to dry to the interior when it does get wet.
- Combining this system with an interior foundation drain and a soil gas vent is highly recommended. This combination of systems increases their effectiveness and helps to lower short-term and long-term levels of moisture and other harmful soil gasses.

[Thank You Sponsors - Together We Improve Homes & People's Lives](#)

Considerations:

- None

Resources:

- TBD - possibly add drawing in future.

4B-22_ Air seal and insulate foundation to R-15 or better on interior

NOTE: MN Rules Chapter 1322 (MN Residential Energy Code as of June 1, 2009) is very specific about foundation insulation, vapor retarders and waterproofing for new foundation walls.

- **Having anything other than R10 for insulation on new foundation walls will most likely require special sign off by a professional engineer.**
- **Installing the proper vapor retarder and/or waterproofing in the proper location is required or sign off by a professional engineer is required.**

Requirements:

- Air sealing must include gaps and penetrations in the rim joists, and penetrations through walls.
- Air seal on interior of foundation wall must be made continuous with capillary break at top of foundation wall.
- Notes on drawings and/or specifications indicating work to be done or product to use.
- Post-installation photo—OR—rater verification

Exceptions:

- None

Rationale:

- Contributes to a more energy efficient house.

Considerations:

- Be careful not to design and install an assembly that drives moisture up into the rim joist assembly area.

Resources:

- TBD - possibly add drawing in future.

4B-23_ Use spray foam to air seal and insulate interior foundation walls and rim joists

[Thank You Sponsors - Together We Improve Homes & People's Lives](#)

NOTE: MN Rules Chapter 1322 (MN Residential Energy Code as of June 1, 2009) is very specific about foundation insulation, vapor retarders and waterproofing for new foundation walls.

- **Having anything other than R10 for insulation on new foundation walls will most likely require special sign off by a professional engineer.**
- **Installing the proper vapor retarder and/or waterproofing in the proper location is required or sign off by a professional engineer is required.**

Note: If foundation cannot dry to exterior above grade through minimum of 16" of exposed foundation and/or rim joist area is not separated from foundation by a capillary break, then closed cell foam insulation CANNOT exceed the thickness that would reduce its vapor permeability to 1 perm or less.

Requirements:

- Air seal all seams including the seam between the vapor barrier and the foundation. Mastic is recommended for sealing because tape will fail over time.
- Notes on drawings and/or specifications indicating work to be done or product to use.
- Post-installation photo—OR—rater verification

Exceptions:

- None

Rationale:

- Rim joists are commonly under-insulated, so by properly insulating the rim joists the insulation value of the wall system greatly increases.
- Spray foam helps fill small gaps not normally sealed by fiberglass batt insulation.

Considerations:

- Be careful not to design and install an assembly that drives moisture up into the rim joist assembly area.

Resources:

- TBD - possibly add drawing in future.

4B-24_ Use steel studs to furr out new foundation walls for finishing

Requirements:

- Notes on drawings and/or specifications indicating work to be done or product to use.
- Post-installation photo—OR—rater verification

Exceptions:

[Thank You Sponsors - Together We Improve Homes & People's Lives](#)

- None
- Rationale:
- If moisture and temperature conditions are ever right for mold growth, steel studs will not supply food source that mold needs like wood does.
- Steel studs typically are made from post-consumer recycled steel, and it is nearly infinitely recyclable when it is removed from the house.

Considerations:

- None

Resources:

- TBD - possibly add drawing in future.

4B-25_ Slope garage slab toward main vehicle entry door (minimum 1/8" per foot) (see 2G-7 for points)

Requirements:

- See [2G - 7](#)

Rationale:

- See 2G - 7

Considerations:

- See 2G - 7

Resources:

- See 2G - 7

4C -New Exterior Walls Above Grade, All New Non-Slab (framed) Floors, All New Interior Partition Walls and All New Ceilings

4C-1_ Use of reclaimed (a.k.a. reused) materials

Select all that apply:

- 4C-1a_ Beams and Headers (50% to 89%)
- 4C-1b_ Beams and Headers (90% or more)
- 4C-1c_ Floor Joists (50% to 89%)
- 4C-1d_ Floor Joists (90% or more)

[Thank You Sponsors - Together We Improve Homes & People's Lives](#)

4C-1e_	Subfloor (50% to 89%)
4C-1f_	Subfloor (90% or more)
4C-1g_	Wall Framing (30% to 49%)
4C-1h_	Wall Framing (50% to 89%)
4C-1i_	Wall Framing (90% or more)
4C-1j_	Vaulted Roof/Ceiling Framing (50% to 89%)
4C-1k_	Vaulted Roof/Ceiling Framing (90% or more)

Requirements:

- Notes on drawings and/or specifications indicating work to be done or product to use.
- Invoice—OR—letter indicating source and/or purchase of product.

Exceptions:

- None

Rationale:

- Use of reclaimed materials contributes to a very efficient use of materials overall.

Considerations:

- Care must be taken to ensure that reclaimed materials are still structurally sound.

Resources:

- TBD

4C-2_ Engineered wood, steel or trusses used (steel required to have minimum 30% recycled content to qualify)

Select all that apply:

4C-2a_	Beams and Headers in walls and floors (eng./steel/truss) (60% to 89%)
4C-2b_	Beams and Headers in walls and floors (eng./steel/truss) (90% or more)
4C-2c_	Floor Joists (eng./steel/truss) (60% to 89%)
4C-2d_	Floor Joists (eng./steel/truss) (90% or more)
4C-2e_	Wall Framing (eng./steel/truss) (30% to 49%)
4C-2f_	Wall Framing (eng./steel/truss) (50% to 89%)
4C-2g_	Wall Framing (eng./steel/truss) (90% or more)

Requirements:

- Qualifying materials generally included anything that is not solid sawn wood, such as LVL, I-Joist, PSL, Timber Strand, finger jointed, floor truss, steel studs with minimum 25% recycled content, and others to be determined.
 - If steel studs are used in the heated envelope, continuous R10 rigid insulation must be installed to the outside of them to prevent thermal bridging.
-

[Thank You Sponsors - Together We Improve Homes & People's Lives](#)

- Notes on drawings and/or specifications indicating work to be done or product to use.
- Post-Installation photo—OR—rater verification

Exceptions:

- None

Rationale:

- Engineer products use wood more efficiently.
- Given the limited availability of large, old growth trees today, it is also difficult to get solid sawn structural members that are as dimensionally stable and resist warping as much as engineered products.
- Steel studs typically are made from 25% post-consumer recycled steel, and it is nearly infinitely recyclable when it is removed from the house.
- Considerations:
- Steel joists and heavy structural components have less recycled content, but are more stable than other building materials

Resources:

- TBD

4C-3_ Advanced FLOOR SHEATHING and EXTERIOR WALL SHEATHING

Select all that apply:

Select all that apply:

- 4C-3a_ Subfloor with no added urea-formaldehyde
- 4C-3b_ Exterior wall sheathing with no added urea-formaldehyde

Requirements:

- Notes on drawings and/or specifications indicating work to be done or product to use.
- Manufacturer Documentation of product specifications.

Exceptions:

- None

Rationale:

- Urea-formaldehyde is a known carcinogen, and has been a common ingredient in the glues used in engineered building materials.
- Phenyl-formaldehyde is a component naturally found in wood products and is different from urea-formaldehyde.

Considerations:

- None
-

[Thank You Sponsors - Together We Improve Homes & People's Lives](#)

Resources:

- TBD

4C-3c_ Install Fiberglass coated gypsum board for exterior wall sheathing. (min. 90% of sheathing)

4C-3d_ Install Magnesium board for exterior wall sheathing (a.k.a. MgO)
(min. 90% of all new wall sheathing)

4C-4_ Certification of structural wood products

Select all that apply:

- 4C-4a_ Plywood, OSB or other sheathing is Forest Stewardship Council certified (50% to 89%)
- 4C-4b_ Plywood, OSB or other sheathing is Forest Stewardship Council certified (90% or more)
- 4C-4c_ Framing Lumber is Forest Stewardship Council certified (50% to 89%)
- 4C-4d_ Framing Lumber is Forest Stewardship Council certified (90% or more)

Requirements:

- Notes on drawings and/or specifications indicating work to be done or product to use.
- Post-installation photo—OR—rater verification
- Invoice and Forest Stewardship Council Certification documentation

Exceptions:

- None

Rationale:

- Forest Stewardship Council certification ensures that the lumber is coming from a well-managed forest.
- FSC has paved the way for Forest Stewardship Council certification of wood products and other certification programs are moving toward equally good standards.

Considerations:

- None

Resources:

- TBD

4C-5_ Local sourcing of structural products (manufactured within 500 miles)

[Thank You Sponsors - Together We Improve Homes & People's Lives](#)

Select all that apply:

- 4C-5a_ Plywood, OSB or other sheathing is local (50% to 89%)
- 4C-5b_ Plywood, OSB or other sheathing is local (90% or more)
- 4C-5c_ Framing lumber is local (50% to 89%)
- 4C-5d_ Framing lumber is local (90% or more)

Requirements:

- LOCALLY SOURCED materials are those that are extracted, harvested, or salvaged/recovered AND produced within 500 miles of the project.
- In this program, 90% of the material(s) in a product must be locally sourced to receive credit. If the product has multiple materials, the source for all of the materials must be documented.
- Notes on drawings and/or specifications indicating work to be done or product to use.
- Post-installation photo—OR—rater verification
- Invoice and/or other documentation indicating source

Exceptions:

- None

Rationale:

- The goal in returning to locally sourced and produced products is to reduce energy used in transportation as well as to stimulate local economies and jobs.
- Local materials may have the added advantage of being exclusive to a region thus providing the opportunity for unique or one of a kind design.

Considerations:

- None

Resources:

- TBD

4C-6_ Panelized construction systems are used

Select all that apply:

- 4C-6a_ Wood framed panels (minimum 80% of interior walls)
- 4C-6b_ Wood framed panels (minimum 80% of exterior walls)
- 4C-6c_ Structural Insulated Panels (SIP) (minimum 80% exterior walls)
- 4C-6d_ Structural Insulated Panels (SIP) (minimum 80% roofs)

Requirements:

- Must be installed according to manufacturer's specifications.
-

[Thank You Sponsors - Together We Improve Homes & People's Lives](#)

- Panel plan from panel manufacturer
- Post-installation photo—OR—rater verification

Exceptions:

- None

Rationale:

- Panelized construction eliminates waste not only on the construction site but in the factory as well, where walls can be carefully planned.
- SIPs are even more resource efficient and energy efficient than wood framed panel systems.

Considerations:

- None

Resources:

- Structural Insulated Panel Association, www.sips.org

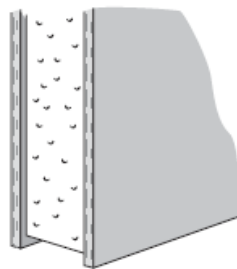

Drawing of a SIP panel

4C-7_ Insulated concrete forms (ICF) or insulated concrete T-Mass or equivalent system is used with a minimum of R14

Requirements:

- Must provide insulation for a minimum 90% of foundation or exterior walls.
- Walls shall be installed according to manufacturer's specifications.
- Notes on drawings and/or specifications indicating work to be done or product to use.
- Post-installation photo—OR—rater verification

Exceptions:

- None
-

[Thank You Sponsors - Together We Improve Homes & People's Lives](#)

Rationale:

- Insulated concrete forms allow for continuous insulation inside as well as outside the building envelope for the excellent insulating effect.
- T-Mass walls are similar, but have the insulation sandwiched between two layers of concrete, which gives the possibility of the concrete serving as the exterior and interior finish. Concrete interior wall finish could be used as thermal mass to help maintain interior temperature and humidity.

Considerations:

- None

Resources:

- TBD

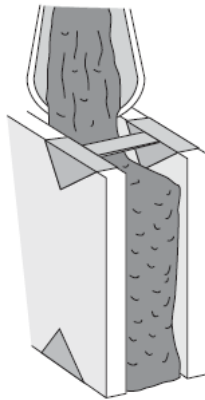

4C-8_ Use Advanced Framing Techniques (a.k.a. Optimum Value Engineering) for wall construction

Select all that apply:

- 4C-8a_ 19.2" or 24" o.c. framing
- 4C-8b_ Two-stud corners with drywall clips
- 4C-8c_ Single top plate
- 4C-8d_ Door and window headers sized for load
- 4C-8e_ Jack studs eliminated (header hanger used)
- 4C-8f_ Insulated T-Wall framing used at intersection of interior and exterior walls

Requirements:

[Thank You Sponsors - Together We Improve Homes & People's Lives](#)

- Window framing shall be laid out to eliminate jack studs as it helps eliminate extra framing required. Header hangers or other support as required by code shall be used.
- The intersecting corner of two insulated walls shall be framed such that insulation is continuous in the external wall (corners with unnecessary 2x4s are not permitted). A “California corner” and two-stud corner with drywall clips are methods of achieving this.
- Notes on drawings and/or specifications indicating work to be done or product to use.
- Post-installation photo—OR—rater verification

Exceptions:

- None

Rationale:

- Advanced Framing Techniques help reduce material usage, construction waste and help increase energy efficiency by reducing the number of studs in a wall
- Sizing and centering windows and doors within a stud bay whenever possible.
- Frame rough openings WITHOUT extra jack studs.
- By aligning upper floor joists or roof trusses on the studs below, only a single top plate is needed. Review construction techniques and have structural engineer approve method and framing layout prior to construction.
- Two-stud corners. Allows for extra insulation in the corners, and also increases the R-value of the wall construction.
- This credit is designed to reward significant changes in the methods used to frame. While developing a baseline for how much framing is required to obtain this credit is difficult, the expectation is that the technique is applied to all framing components and framing comprises a more than token portion of the project. (Framing a 2’x3’ closet would not qualify for OVE if framing is 24” o.c.)

Considerations:

- None

Resources:

- See drawings below

Framing of window or door opening showing header hanger and NO Jack stud

[Thank You Sponsors - Together We Improve Homes & People’s Lives](#)

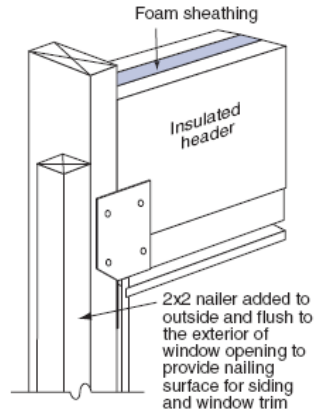

Two-stud corner

Insulated "T" Wall intersection

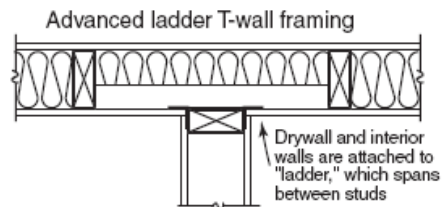
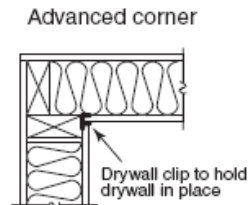
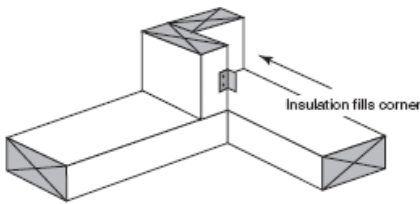

4C-9_ Advanced insulation materials and techniques used

Select all that apply:

- 4C-9a_** Insulation with minimum 20% recycled content is used for at least 50% of applications (based on R-value x sq. ft.)

[Thank You Sponsors - Together We Improve Homes & People's Lives](#)

- 4C-9b_ All-natural insulation, such as cotton batt, is used for at least 50% of applications. (Soy based foam insulation is not considered "all natural" and is not eligible for credit in this category)
- 4C-9c_ Spray foam insulation applied in new studs
- 4C-9d_ Spray applied wet cellulose insulation (proper drying required before installing wall finish and/or vapor barrier)
- 4C-9e_ Cavity insulation between studs in exterior walls is greater than R19
- 4C-9f_ Rim joist connecting two conditioned floors are insulated to greater than R-23
- 4C-9g_ Floor over unheated space air sealed and insulated to minimum R38
- 4C-9h_ Insulated headers (minimum of 80% of new headers)

Requirements:

- 4C-9a. Recycled content must be certified by Scientific Certification Systems (SCS) or the manufacturer. SCS is on the web at www.scs1.com
- Notes on drawings and/or specifications indicating work to be done or product to use.
- Post-installation photo—OR—rater verification
- Manufacturer documentation

Exceptions:

- None

Rationale:

- Improves energy efficiency

Considerations:

- None

Resources:

- See drawings below
- Examples of insulated headers (other configurations are also acceptable)

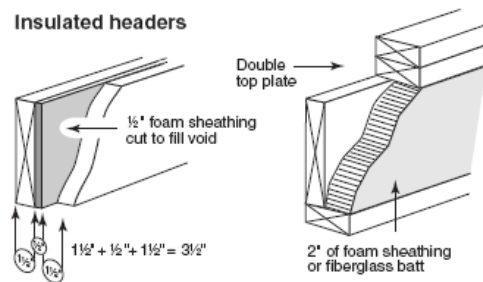

Cantilevered floor insulated to R38

[Thank You Sponsors - Together We Improve Homes & People's Lives](#)

4C-10_ Advanced air sealing techniques used.

Select all that apply:

- 4C-10a_ Bottom plates of exterior walls sealed to floor or foundation with a proper sealant.

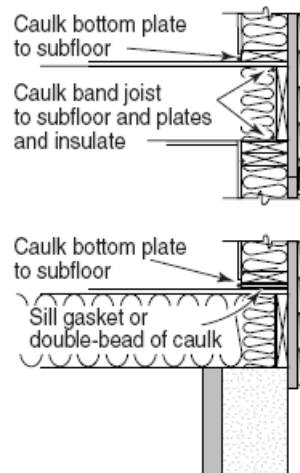

- 4C-10b_ Seams and penetrations in rim joist between conditioned floors are sealed

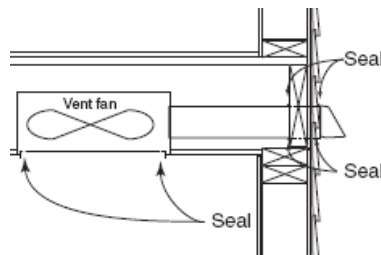

- 4C-10c_ Seal rim joists at all locations and connection with attic at exterior walls
Need Picture or graphic.

- 4C-10d_ Air seal penetrations and joints in fireplace framing.

[Thank You Sponsors - Together We Improve Homes & People's Lives](#)

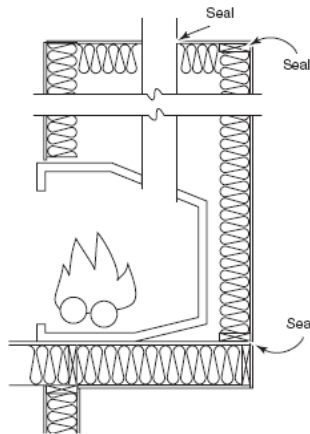

4C-10e_ Cantilevered floor sealed above supporting wall.

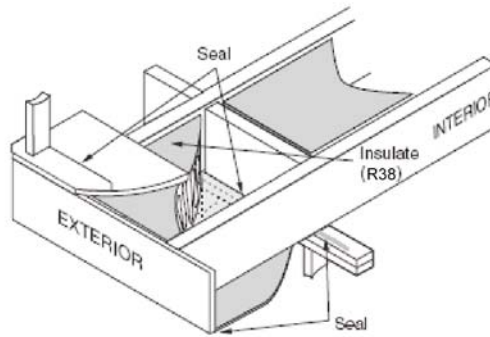

Air seal and insulate cantilevered floors.

4C-10f_ Stud cavities shall be blocked at locations of varying ceiling height, such as in common walls between adjacent rooms.

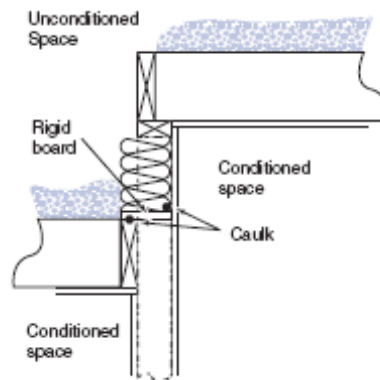

[Thank You Sponsors - Together We Improve Homes & People's Lives](#)

4C-10g_ Seal all gypsum or magnesium board penetrations in exterior walls using caulk, gaskets or appropriate connection with gypsum board.
Need Picture or graphic.

4C-10h_ Seal drywall at top plate, bottom plate and penetrations with gasket, sealant or glue.

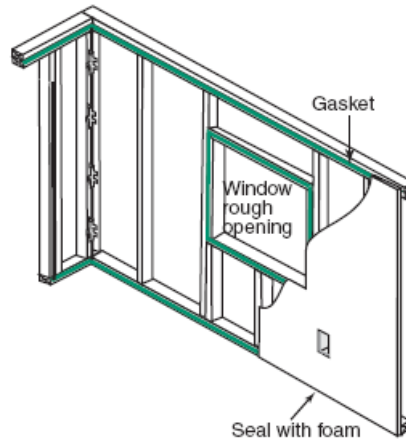

4C-10i_ Exterior sheathing with no gaps larger than 0.25 inches.
Need Picture or graphic.

Requirements:

- Notes on drawings and/or specifications indicating work to be done or product to use.
- Post-installation photo—OR—rater verification.

Exceptions:

- None

Rationale:

- Improves energy efficiency and durability

Considerations:

- None

Resources:

- See drawings below

4C-11_ Advanced siding materials and techniques used on new walls.

[Thank You Sponsors - Together We Improve Homes & People's Lives](#)

- [See 3C-11.](#)

4C-12_ Advanced interior finish material used on new walls

4C-12a_ Fiberglass coated gypsum board installed for interior wall material. (min. 90% of all new walls and ceilings)

Requirements:

- Notes on plans or specifications indicating material to be used and/or work to be done.
- Manufacturer documentation of product specifications.
- Pre-painting (or other surface coating)—OR—rater verification

Exceptions:

- None

Rationale:

- Fiberglass-faced gypsum board does not support mold growth like paper-faced gypsum board does.
- The paper that is used on most gypsum board is an excellent food source for mold when moisture and temperature considerations are right. Eliminating that food source is one way to reduce the risk of mold growth in the home.

Considerations:

- Users should become familiar with fiberglass-faced gypsum board and use personal safety protection when working with it.
- The texture is different from paper-faced gypsum board, which makes the finishing process different. Also, when cutting and installing, small pieces of the coating can become airborne; this can irritate the eyes, skin and respiratory system if personal safety protection is not used.

Resources:

- TBD

4C-12b_ Magnesium Oxide (a.k.a. MgO) board installed for interior wall and/or ceiling material.

(min. 90% of all new walls & ceilings)

Requirements:

[Thank You Sponsors - Together We Improve Homes & People's Lives](#)

- Notes on plans or specifications indicating material to be used and/or work to be done.
- Manufacturer documentation of product specifications.
- Photo before painting or other surface coating is applied

Exceptions:

- None

Rationale:

- Magnesium is a mold inhibitor, and therefore magnesium board does not support mold growth like traditional paper-faced gypsum does.
- MgO is a type of sheathing board-sort of like drywall or cement board-but with much-improved characteristics such as fire resistance, weather-ability, strength, resistance to mold and mildew
- The surface is smooth so traditional finishing methods are mostly the same.
- Concerns about delamination or small fibers becoming air borne do not exist as they do with some other fiber-cement and fiberglass gypsum products respectively.
- When and if MgO board is mined and produced locally, it may qualify for Resource Efficiency points.

Considerations:

- Currently most MgO board is manufactured in Asia and is imported to the U.S.

Resources:

- TBD

**4C-12c_ Install plaster and lathe for interior wall and/or ceiling material.
(min. 90% of all new walls & ceilings)**

Requirements:

- Create detailed specifications that identify preferred wall/ceiling treatment by area.
- Review with installers prior to installation.

Exceptions:

- None

Rationale:

- Natural plaster is made of naturally occurring minerals. Because it is a naturally occurring material, it uses less energy to produce.

[Thank You Sponsors - Together We Improve Homes & People's Lives](#)

- Plaster is both the structure and the topcoat thereby saving Resources. When it is mixed on-site it saves on waste.

Considerations:

- Synthetic materials are often added to plaster, so be sure to specify natural plaster.

Resources:

- TBD

4C-13_ Gypsum wallboard (GWB) is held a minimum 1/2" from concrete slabs (applies to existing GWB or newly installed GWB)

Requirements:

- Notes on plans or specifications indicating material to be used and/or work to be done.
- Pre-base board installation photo—OR—rater verification
- The absence of GWB or smaller material in this condition does not allow access to this credit.

Exceptions:

- None

Rationale:

- Preventing GWB from being in contact with concrete helps eliminate any chance that it will wick up moisture from the concrete.

Considerations:

- None

Resources:

- TBD

4D - New Windows, Skylights and Doors

ENERGY STAR and National Fenestration Rating Council are excellent Resources for finding new windows, skylights, and doors that are energy efficient and rated by a third party.

[Thank You Sponsors - Together We Improve Homes & People's Lives](#)

A new window, skylight, or door consists of a new frame, sill (none if a skylight), and flashing. Install new components to manufacturer and code requirements. An example of a new window is a window going into a new location, or in an existing rough opening where the existing unit has been completely removed and the rough opening is exposed. Follow manufacturer specifications for integrating exterior air/vapor barrier at new windows and doors, as well as follow installation instructions for flashing and sealing.

Skylights are a good strategy to bring light and ventilation into a finished attic space, or to bring light to a first floor such as with a light shaft. Skylights can also be a significant source of heat gain and loss if improperly located on a home. For this reason, skylights are not rewarded points in this category. East and north sides of the home are better suited for skylights, where west and south sides can receive significant amounts of direct sunlight. If used, keep skylight use to a minimum and for daylighting and ventilation. Consider solar orientation and shading strategies carefully. ENERGY STAR-rated solar light tubes are an effective and efficient alternative to the problems skylights can create. ENERGY STAR-rated solar light tubes can provide daylight illumination without direct solar gain.

Different window and door materials have different energy efficiency ratings, as well as have embodied energy values. Some windows and doors have been chosen either because they match existing windows, or they represent lower long-term maintenance.

4D-PR1_ New and replacement units must meet energy code (existing windows are exempt)

Requirements:

- Notes on drawings and/or specifications indicating work to be done or product to use.
- Manufacturer documentation

Exceptions:

- Existing windows are exempt.

Rationale:

- Energy code is often overlooked in remodeling. Even though this measure is already required by the Minnesota State Energy Code, it is worth reminding program participants.

Considerations:

- None

Resources:

- Existing Minnesota Residential Energy Code, see Minnesota Rules Chapter 7672

[Thank You Sponsors - Together We Improve Homes & People's Lives](#)

(www.state.mn.us/portal/mn/jsp/content.do?subchannel=-536881494andprogramid=536894293andsc3=nullandsc2=-536882175andid=-536881350andagency=Commerce)

4D-PR2_ Windows must be ENERGY STAR and National Fenestration Rating Council (NFRC) labeled (existing window sash are exempt)

Requirements:

- Notes on drawings and/or specifications indicating work to be done or product to use.
- Provide window manufacturer documentation. See examples below.

	World's Best Window Co. Millennium 2000+ Clad Wood Frame Double Glazing + Argon Fill + LowE Product Type: Vertical Slider
ENERGY PERFORMANCE RATINGS	
U-Factor (U.S./1-F) 0.35	Solar Heat Gain Coefficient 0.32
ADDITIONAL PERFORMANCE RATINGS	
Visible Transmittance 0.51	Air Leakage (U.S./1-F) 0.2
Condensation Resistance 51	—
<small>Manufacturer certifies that these ratings conform to applicable NFRC procedures for determining whole product energy performance. NFRC ratings are determined for a fixed set of environmental conditions and specific product sizes. www.nfrc.org</small>	



www.energystar.gov

Exceptions:

- Existing windows are exempt.

Rationale:

- These are product quality assurance programs that set a good standard for factory-built windows.

Considerations:

- None

Resources:

- TBD

4D-PR3_ Flash windows and exterior doors with pan, side and head flashing

Requirements:

- All windows and exterior doors are to have a water resistant flashing (metal, plastic, or window manufacturer approved alternative material) installed on the side and base
-

[Thank You Sponsors - Together We Improve Homes & People's Lives](#)

of window and door rough openings a maximum of 6” above the top of the window or door to direct water leaks out of the framing.

- Notes on drawings and/or specifications indicating work to be done or product to use.
- Post-installation photo—OR—rater verification

Exceptions:

- None

Rationale:

- Extremely important strategy to keep bulk water from leaking into the walls.

Considerations:

- Careful attention must be paid to getting all of this flashing installed properly, or leaks will occur.

Resources:

- Example of plastic sill flashing

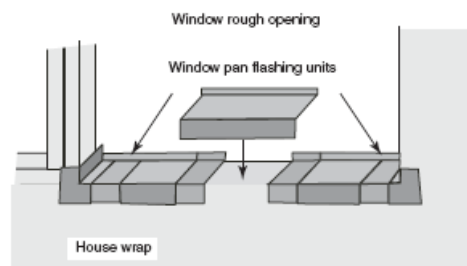

4D-PR5_ Air seal around outside of window and door units with low expansion foam insulation

Requirements:

- Seal the space between the framing for window or door (including attic access) Rough openings and the installed units with low-expanding spray foam sealant, closed cell foam backer rod, spray applied insulation, or other suitable sealant.
 - Cellulose, fiberglass, or rock wool batt insulation is not acceptable as a sealant but can be used as a backing for a sealant (such as caulk). Thresholds for exterior doors shall be sealed to the subfloor.
 - Notes on drawings and/or specifications indicating work to be done or product to use.
 - Post-installation photo—OR—rater verification
-

[Thank You Sponsors - Together We Improve Homes & People's Lives](#)

Exceptions:

- None

Rationale:

- Traditionally this has been a difficult area to air seal and insulate, but low-expansion foam sealants have made it much easier.

Considerations:

- None

Resources:

- TBD

4D-PR6_ New connecting doors between living space and garage are self closing and ≤ 0.30 cfm/sq. ft. air leakage rating.

Requirements:

- Specifications of door for leakage rating.
- Photograph of self-closing mechanism on door before project completion.
- Photograph showing tight-fitting weather stripping & threshold of door when in closed position.

Exceptions:

- None

Rationale:

- Garages have a lot of pollutants that are best kept out of the house.
- The door between the garage and the house plays an important role in this and should be kept closed and airtight as much as possible.

Considerations:

- None

Resources:

- TBD

4D-1_ Install new windows and/or skylights (minimum 90% of units)

Select all that apply:

4D-1a_ Windows and/or skylights have a U-factor of 0.32

[Thank You Sponsors - Together We Improve Homes & People's Lives](#)

- 4D-1b_ Windows and/or skylights have a U-factor of 0.29 to 0.31
- 4D-1c_ Windows and/or skylights have a U-factor of 0.25 to 0.29
- 4D-1d_ Windows and/or skylights have a U-factor of 0.24 or less

Requirements (4D - 1a, 1b, 1c, 1d):

- Provide manufacturer documentation

Exceptions:

- None

Rationale:

- 4D - 1a → 4D - 1d are for energy performance characteristics of new windows. A low U-factor indicates better energy performance.

Considerations:

- None

Resources:

- TBD

4D-1e_ Windows are wood

4D-1f_ Windows and/or skylights are fiberglass

4D-1g_ Windows and/or skylights are wood-with metal clad exterior

Requirements (4D - 1e, 1f, 1g):

- Provide manufacturer documentation

Exceptions:

- None

Rationale:

- 4D - 1e_ → 4D - 1g_ are for durability characteristics of new windows. Wood exterior windows require more maintenance over time, but have low embodied energy, and are valued by society over the other types of windows.

Considerations:

- None

Resources:

- TBD

4D-1h_ Window and/or skylight air leakage rating < 0.30 cfm/sq. ft.

Requirements:

- Provide manufacturer documentation

Exceptions:

- None

[Thank You Sponsors - Together We Improve Homes & People's Lives](#)

Rationale:

- Windows that leak less air are more energy efficient and more durable.

Considerations:

- None

Resources:

- TBD

4D-1i_ East/west facing windows and/or skylights have SHGC \leq 0.35

4D-1j_ Install Northern Glass on Southern exposures

Requirements (4D - 1i, 1j):

- Provide manufacturer documentation

Exceptions:

- None

Rationale:

- A high SHGC is desirable for southern windows in Minnesota during the day to capture heat from the sun. Northern glass is like a one way mirror in that it has a high SHGC (.60 or more) on one side, allowing heat to enter, and a low SHGC (.30) on the other side keeping heat in at night
- A solar path diagram for Minnesota would show that there are a lot of times during the day during the summer months when the sun is low in the eastern or western sky, and cannot be blocked by overhangs or other horizontal shading devices.
- A low SHGC on east and west facing windows helps to prevent overheating during these times.
- During the winter months when we would want to allow the sun to penetrate into the building, the sun never gets to a position that is low in the eastern or western sky, Thus east and west windows are of little value for solar gain during these months. On the other hand, in the summer, when we want to prevent heat gain, the sun does get low in the eastern and western sky. Therefore the low SHGC of eastern and western windows help keep the house cool in the summer, and is NOT a liability in the winter.

Considerations:

- None

Resources:

- TBD

[Thank You Sponsors - Together We Improve Homes & People's Lives](#)

4D-1k_ Add exterior shading to new windows on south and west side of home, such as awnings on south or west, vertical fins on west, etc.

Requirements:

- Documentation required showing projection size including depth of overhang, height of window and a diagram of sun angles for winter and summer
- Roof overhangs also qualify if properly sized and documented
- Proper sizing ensures effective use of materials and that strategies have been well considered
- Notes on drawings and/or specifications indicating work to be done or product to use
- Provide manufacturer documentation

Exceptions:

- None

Rationale:

- Properly sized exterior shading helps reduce heat gain during the months when it is not desired.

Considerations:

- None

Resources:

- Pilkington Sun Angle Calculator at www.sbse.org/resources/sac/PSAC_Manual.pdf

4D-1L_ Install storm windows on double hung or fixed windows

Requirements:

- Notes on plan and/or specifications stating addition of storm windows
- Post-construction photo-OR-rater sign off

Exceptions:

- None

Rationale:

- Storm windows help improve energy efficiency by creating a dead air space between them and the main window; this reduces heat loss or gain, and they reduced infiltration.
- They improve durability by protecting the inner main window from rain, ice and snow.
- Some storm windows also have Low E (or other) coatings on the glass, which also help improve energy efficiency.

[Thank You Sponsors - Together We Improve Homes & People's Lives](#)

Considerations:

- None

Resources:

- TBD

4D-1m_ Wood used in window construction (if any) has full FSC Certification

Requirements:

- Provide manufacturer documentation

Exceptions:

- None

Rationale:

- Forest Stewardship Council certification ensures that the wood is coming from a well-managed forest.

Considerations:

- None

Resources:

- TBD

4D-1n_ 20-year warranty on windows with wood frame (warranty must apply to glazing, sash and frame) (minimum 90% of new units)

Requirements:

- Provide manufacturer documentation

Exceptions:

- None

Rationale:

- Most window and door manufacturers currently only offer a 10-year warranty for the frame, and a 20-year warranty for the glazing and seals. Some companies have started to increase this to 20 years for the whole unit. These longer warranties are encouraged.

Considerations:

- None

Resources:

- TBD

[Thank You Sponsors - Together We Improve Homes & People's Lives](#)

4D-2_ West facing glazing less than 2% of floor area

Requirements:

- Provide calculations

Exceptions:

- None

Rationale:

- West facing windows have high solar gain

Considerations:

- None

Resources:

- TBD

4D-3_ East facing glazing less than 3% of floor area

Requirements:

- Provide calculations

Exceptions:

- None

Rationale:

- East facing windows have lower solar gain than west windows, but contribute to significant solar heat gain in the summer months

Considerations:

- None

Resources:

- TBD

4D-4_ Install ENERGY STAR light tubes to bring light to interior areas that receive limited daylight

Requirements:

- Notes on drawings and/or specifications indicating work to be done or product to use.

[Thank You Sponsors - Together We Improve Homes & People's Lives](#)

- Post-construction photo—OR—rater verification

Exceptions:

- None

Rationale:

- Install them in areas such as hallways or interior bathrooms with no windows
- Reduces the need for electric lighting, and are more energy efficient skylights

Considerations:

- None

Resources:

- TBD

4D-5_ Install, adjustable interior solar shades, or reflective blinds to minimum 80% of all (existing and new) east, west, and south windows/skylights, which have no exterior shading to block summer sun (see 3D-8 for points)

4D-6_ New cover on a new entry. Must extend three feet out from new entry. (See Subsection 3D for covers on existing entries.)

Select Only One:

- | | |
|----------------|-----------------------|
| 4D-6a_ | 1 new entry |
| 4D-6b _ | 2 or more new entries |

Requirements:

- Notes on drawings and/or specifications indicating work to be done or product to use.
- Post-construction photo—OR—rater verification

Exceptions:

- None

Rationale:

- Covers at entries improve durability of the entry door assemblies by protecting them from the weather.

Considerations:

- None
-

[Thank You Sponsors - Together We Improve Homes & People's Lives](#)

Resources:

- TBD

4D-7_ Doors at entry between conditioned and unconditioned space and/or between interior and exterior

Select all that apply:

- 4D-7a_ Door(s) with 1/2 glass or less (minimum 90% of all doors of this type) U-factor is 0.18 to 0.20
- 4D-7b_ Door(s) with 1/2 glass or less (minimum 90% of all doors of this type) U-factor is ≤ 0.17 .
- 4D-7c_ Door(s) with 1/2 glass or more (minimum 90% of all doors of this type) U-factor is 0.31 to 0.47.
- 4D-7d_ Door(s) with 1/2 glass or more (minimum 90% of all doors of this type) U-factor is ≤ 0.30 .

Requirements:

- Notes on drawings and/or specifications indicating work to be done or product to use
- Provide manufacturer documentation

Exceptions:

- None

Rationale:

- 4D-7a → 4D-7d are for energy performance characteristics of new doors.
- A low U-factor indicates better energy performance.

Considerations:

- None

Resources:

- TBD

4D-7e_ Door(s) are wood

4D-7f_ Door(s) have metal outer skin (e.g., aluminum or steel)

4D-7g_ Door(s) have fiberglass outer skin

[Thank You Sponsors - Together We Improve Homes & People's Lives](#)

Requirements:

- Notes on drawings and/or specifications indicating work to be done or product to use
- Provide manufacturer documentation

Exceptions:

- None

Rationale:

- 4D-1e → 4D-1g are for durability characteristics of new doors.
- Wood has low embodied energy, a long life span and a respectable energy rating.
- Steel doors have an overall durability similar to wood. On one hand, steel typically needs less repainting or staining, but on the other hand it dents easily, which can result in an increased need for repainting or complete door replacement. Steel has a higher embodied energy than other doors.
- Fiberglass is very durable, holds paint and stain well, and is not prone to denting like metal. Other benefits of fiberglass include its similar dimensional stability as the glazing itself, which means the glazing seals should last longer. The downside of fiberglass is its high-embodied energy.

Considerations:

- None

Resources:

- TBD

4D-7h_ Wood used in door(s) (if any) has Forest Stewardship Council Certification (90% of doors containing wood)

Requirements:

- Notes on drawings and/or specifications indicating work to be done or product to use
- Provide manufacturer documentation

Exceptions:

- None

Rationale:

- Forest Stewardship Council certification ensures that the wood is coming from a well-managed forest.

Considerations:

- None
-

[Thank You Sponsors - Together We Improve Homes & People's Lives](#)

Resources:

- TBD

4D-7i_ Install storm door at all entries (sliding doors exempt)

Requirements:

- Notes on plan and/or specifications stating addition of storm doors Post-construction photo-OR-rater sign off

Exceptions:

- None

Rationale:

- Storm doors help improve energy efficiency by creating a dead air space between them and the main door. This decreases heat loss or gain through the doorway, and decreases air infiltration.
- They improve durability by protecting the inner main door from rain, ice, and snow.

Considerations:

- None

Resources:

- TBD

4D-7j_ 20-year warranty on all doors with wood frame (warranty must apply to glazing, sash and frame)

Requirements:

- Notes on drawings and/or specifications indicating work to be done or product to use Provide manufacturer documentation

Exceptions:

- None

Rationale:

- Most window and door manufacturers currently only offer a 10-year warranty for the frame, and a 20-year warranty for the glazing and seals. Some companies have started to increase this to 20 years for the whole unit. These longer warranties are encouraged.

Considerations:

[Thank You Sponsors - Together We Improve Homes & People's Lives](#)

- None

Resources:

- TBD

4E - New attics and roof additions recommendation

Roofing completion and penetration plan posted and enforced to prevent bulk water intrusion prior to the installation of any insulation material, including HVAC ductwork. Shall be implemented by the homeowner or their contractor. Protocols for the immediate repair of any roof penetrations during the course of construction shall be posted, coordinated, and enforced to prevent bulk water intrusion after “dried-in” considerations have been achieved in the building (EC, 40.2).

Proper installation of the roof and its related components is critical to maximize the life of the roof. Review the manufacturer’s warranty and specifications. Hot Roofs, where spray insulation is applied to underside of roof sheathing between roof joists or trusses are currently not approved in all municipalities. Review this construction technique with building code officials. For this reason, it is not included in this section.

4E-PR1_ No recessed light fixtures in finished attic space, or recessed light fixture housing from a conditioned space protruding into an unconditioned attic space, unless installations can be met based on diagram 3PR-7

Requirements:

- See 3PR-7

Exceptions:

- None

Rationale:

- It is extremely difficult to properly air seal and insulate around a recessed light fixture
- Keep installation of any recessed light fixtures to a minimum, and use them only where necessary (not just for effect), such as low ceiling areas, areas with low clearances, or where the installation of a more effective light fixture is not possible.
- Look for recessed light fixtures that are compact fluorescent-compatible.

Considerations:

- See 3PR-7

[Thank You Sponsors - Together We Improve Homes & People’s Lives](#)

Resources:

- See 3PR-7

4E-PR2_ Provide attic insulation thickness markers

Requirements:

- The thickness of blown-in or sprayed roof and ceiling insulation (fiberglass or cellulose) shall be written in inches (mm) on markers that are installed at least one for every 100 square feet throughout the attic space.
- The markers shall be affixed to the trusses or joists and marked with the minimum initial installed thickness with numbers a minimum of 1” high.
- Each marker shall face the attic access opening.
- Spray polyurethane foam thickness and installed R-value shall be listed on the certificate provided by the insulation installer.

Exceptions:

- None

Rationale:

- Necessary for installers, inspectors, and homeowners to know for sure that the designated amounts of insulation were installed.
- Makes it possible to observe insulation over time to see if settling has occurred.

Considerations:

- None

Resources:

- TBD

4E-PR3_ Provide attic information card

Requirements:

- A signed and dated insulation receipt attic card must be attached to the framing near the access opening, and clearly visible.
- The attic card must identify the type of insulation installed, the manufacturer, the installer, the R-value per inch, the designed settled thickness, the square footage of attic coverage area, and the number of bags installed.
- Include a copy of FTC Fact Sheet stating R-value.

Exceptions:

[Thank You Sponsors - Together We Improve Homes & People's Lives](#)

- None

Rationale:

- Ensures accurate information is used regarding performance of insulation products.

Considerations:

- None

Resources:

- The correct R-value for reflective insulation or any other type of insulation can be found on the manufacturer's FTC Fact Sheet, which is required to be available to all customers by the Federal Trade Commission R-Value Rule. The Minnesota Department of Commerce maintains a list of residential insulation products that comply with the Minnesota Residential Thermal Insulation Standards program. Call the Energy Information Center at (651) 926-5120 or 1 (800) 657-3710.

4E-PR4_ If batt insulation is used to insulate knee walls, an attic-side air barrier is required

Requirements:

- Notes on drawings and/or specifications indicating work to be done or product to use.
- Vapor permeable air barriers such as a wind-wash barrier or sheetrock qualify. Craft-faced batts also qualify if craft-face installed to the attic side.
- Post-Installation photo—OR—rater verification

Exceptions:

- None

Rationale:

- Improves energy efficiency
- In knee wall locations, batt insulation is commonly installed with its attic side exposed. This allows attic air to circulate freely in and out of the batt insulation, which significantly reduces its insulating value.

Considerations:

- Care must be taken to not create a double vapor barrier when attempting to install the attic-side air barrier.

Resources:

- TBD

4E-PR5_ Step flashing and kick-out flashing required at all roof/sidewall locations

[Thank You Sponsors - Together We Improve Homes & People's Lives](#)

Requirements:

- Notes on drawings and/or specifications indicating work to be done or product to use.
- Post-Installation photo—OR—rater verification

Exceptions:

- None

Rationale:

- Prevents water intrusion problems

Considerations:

- None

Resources:

- Kick-out flashing location

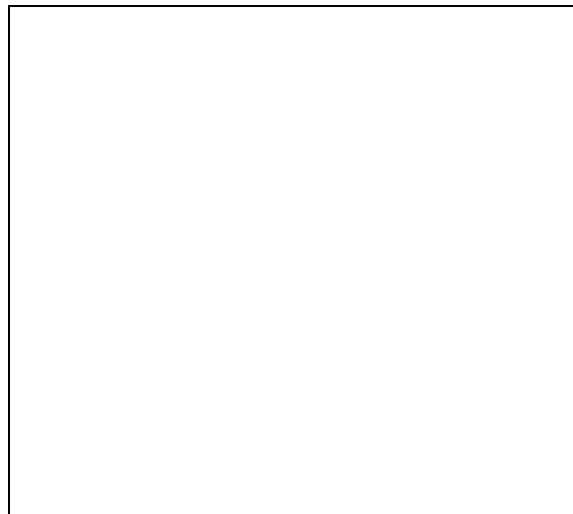

4E-1_ Use of reclaimed (a.k.a. reused) and recycled roof materials

Select all that apply:

- 4E-1a_ Roof Beams and Headers reclaimed (50% to 69%)
 - 4E-1b_ Roof Beams and Headers reclaimed (70% to 89%)
 - 4E-1c_ Roof Beams and Headers reclaimed (90% or more)
 - 4E-1d_ Rafters or Trusses reclaimed (50% to 69%)
 - 4E-1e_ Rafters or Trusses reclaimed (70% to 89%)
-

[Thank You Sponsors - Together We Improve Homes & People's Lives](#)

- 4E-1f_ Rafters of Trusses reclaimed (90% or more)
- 4E-1g_ Roof Sheathing reclaimed (50% to 69%)
- 4E-1h_ Roof Sheathing reclaimed (70% to 89%)
- 4E-1i_ Roof Sheathing reclaimed (90% or more)
- 4E-1j_ Install recycled content roofing material (minimum 25% recycled content)

Requirements:

- Notes on drawings and/or specifications indicating work to be done or product to use.
- Invoice—OR—letter indicating source and/or purchase of product.

Exceptions:

- None

Rationale:

- Use of reclaimed materials contributes to a very efficient use of materials overall.

Considerations:

- Care must be taken to ensure that reclaimed materials are still structurally sound.

Resources:

- TBD

4E-2_ Engineered wood, steel or trusses used (steel required to have minimum 30% recycled content to qualify)

Select all that apply:

- 4E-2a_ Roof Beams and Headers (50% to 89%)
- 4E-2b_ Roof Beams and Headers (90% or more)
- 4E-2c_ Roof Framing (50% to 89%) (roof trusses qualify)
- 4E-2d_ Roof Framing (90% or more) (roof trusses qualify)

Requirements:

- Qualifying materials generally included anything that is not solid sawn wood, such as: LVL, I-Joist, PSL, Timber Strand, finger jointed, floor truss, steel with minimum 30% recycled content, and others to be determined.
- If steel rafters are used in the heated envelope, continuous R10 rigid insulation must be installed to the outside of them to prevent thermal bridging.
- Notes on drawings and/or specifications indicating work to be done or product to use.
- Post-Installation photo—OR—rater verification

Exceptions:

[Thank You Sponsors - Together We Improve Homes & People's Lives](#)



- None

Rationale:

- Engineer products use wood more efficiently.
- Given the limited availability of large, old growth trees today, it is also difficult to get solid sawn structural members that are as dimensionally stable and resist warping as much as engineered products.
- Steel studs typically are made from post-consumer recycled steel, and it is nearly infinitely recyclable when it is removed from the house.

Considerations:

- If installing continuous rigid insulation on the exterior of steel rafters, care must be taken in designing the rest of the roof assembly to not create a double vapor barrier situation.

Resources:

- TBD

4E-3_ No added urea-formaldehyde in roofing materials

Select all that apply:

4E-3a_ Roof Sheathing with no added urea-formaldehyde

Requirements:

- Notes on drawings and/or specifications indicating work to be done or product to use.
- Manufacturer documentation of product specifications.

Exceptions:

- None

Rationale:

- Urea-formaldehyde is a known carcinogen, and has been a common ingredient in the glues used in engineered building materials.
- Phenol-formaldehyde is a component found naturally in wood products and is different from urea-formaldehyde.

Considerations:

- None

Resources:

- TBD

[Thank You Sponsors - Together We Improve Homes & People's Lives](#)

4E-4_Certification of structural wood products

Select all that apply:

- 4E-4a_ Roof sheathing is Forest Stewardship Council certified (50% to 89%)
- 4E-4b_ Roof sheathing is Forest Stewardship Council certified (90% or more)
- 4E-4c_ Roof Framing Lumber is Forest Stewardship Council certified (50% to 89%)
- 4E-4d_ Roof Framing Lumber is Forest Stewardship Council certified (90% or more)

Requirements:

- Notes on drawings and/or specifications indicating work to be done or product to use.
- Post-installation photo—OR—rater verification
- Invoice and Forest Stewardship Council documentation

Exceptions:

- None

Rationale:

- Forest Stewardship Council certification ensures that the lumber is coming from a well-managed forest.
- FSC has paved the way for Forest Stewardship Council certification for wood products, and other forest certification programs are moving toward equally good standards.

Considerations:

- None

Resources:

- TBD

4E-5_ Local sourcing of structural wood products

Select all that apply:

- 4E-5a_ Plywood, OSB or other sheathing is local (50% to 89%)
- 4E-5b_ Plywood, OSB or other sheathing is local (90% or more)
- 4E-5c_ Framing Lumber is local. (50% to 89%)
- 4E-5d_ Framing Lumber is local. (90% or more)

Requirements:

[Thank You Sponsors - Together We Improve Homes & People's Lives](#)

- LOCALLY SOURCED materials are those that are extracted, harvested, or salvaged/recovered AND produced within 500 miles of the project.
- In this program, 90% of the material(s) in a product must be locally sourced to receive credit. If the product has multiple materials, the source for all the materials must be documented.
- Notes on drawings and/or specifications indicating work to be done or product to use.
- Post-installation photo—OR—rater verification
- Invoice and/or other documentation indicating source

Exceptions:

- None

Rationale:

- The goal in returning to locally sourced and produced products is to reduce energy used in transportation as well as to stimulate local economies and jobs.
- Local materials may have the added advantage of being exclusive to a region thus providing the opportunity for unique or one of a kind design.

Considerations:

- None

Resources:

- TBD

4E-6_ Panelized construction systems are used

Select all that apply:

- 4E-6a_ Wood framed panels (minimum 80% of sq. ft. of roofs)(see 4E-2 for trusses)
- 4E-6b_ Structural Insulated Panels (SIP) (minimum R38)(minimum 80% of sq. ft. of roofs)

Requirements:

- Must be installed according to manufacturer's specifications.
- Panel plan from panel manufacturer
- Post-installation photo—OR—rater verification

Exceptions:

- None

Rationale:

[Thank You Sponsors - Together We Improve Homes & People's Lives](#)

- Panelized construction eliminates waste not only on the construction site, but in the factory as well, where framing layouts can be carefully planned.
- SIPs are even more resource efficient and energy efficient than wood framed panel systems.

Considerations:

- None

Resources:

- Structural Insulated Panel Association, www.sips.org

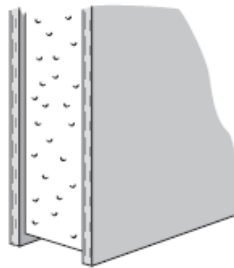

Drawing of a SIP panel

4E-7_ Use Advanced Framing Techniques (a.k.a. Optimum Value Engineering - OVE) for roof construction

Select all that apply:

- 4E-7a_ 19.2" or 24" o.c. roof framing
 4E-7b_ Rafters align with wall framing below

Requirements:

- Notes on drawings and/or specifications indicating work to be done or product to use.
- Post-installation photo—OR—rater verification

Exceptions:

- None

Rationale:

- Advanced Framing Techniques help reduce material usage, construction waste, and help increase energy efficiency by reducing the amount of framing in a roof.

[Thank You Sponsors - Together We Improve Homes & People's Lives](#)

- Size and center skylights in rafter bays whenever possible.
- Frame rough openings WITHOUT extra jack studs.
- By aligning roof framing on the studs below, only a single top plate is needed. Review construction techniques and have structural engineer approve method and framing layout prior to construction.
- This credit is designed to reward significant changes in the methods used to frame. While developing a baseline for how much framing is required to obtain this credit is difficult, the expectation is that the technique is applied to all framing components and framing comprises a more than token portion of the project (i.e., framing a 2'x3' closet would not qualify for OVE if framing is 24" o.c).

Considerations:

- None

Resources:

- TBD

4E-8_ New attic built using Advanced Insulation materials & techniques.

General Considerations:

- When R-value gets above R60, there is typically very little increase in performance without significant cost and space requirements.

Select all that apply:

4E-8a_ Insulation with minimum 20% recycled content is used for at least 50% of applications (based on R-value x sq. ft.)

Requirements:

- 4E-8a. Recycled content must be certified by Scientific Certification Systems (SCS) or the manufacturer. SCS is on the web at www.scs1.com
- Manufacturer Specifications

4E-8b_ All-natural insulation, such as cotton batt, is used for at least 50% of applications. (Soy based foam insulation is not considered "all natural" and is not eligible for credit in this category)

Requirements:

- Rater Sign Off

4E-8c_ Attic insulation total R44 to R49 (flat or vaulted)

Requirements:

- Rater Sign Off

4E-8d_ Attic insulation total R50 or more (flat or vaulted)

[Thank You Sponsors - Together We Improve Homes & People's Lives](#)

Requirements:

- Rater Sign Off

4E-8e_ Add 1" minimum foil face polyisocyanurate insulation to sloped roof / ceiling for thermal break and vapor barrier

4E-8f_ Add 2" rigid insulation to interior of sloped roof / ceiling for thermal break and vapor barrier

Requirements:

- Manufacturer documentation to demonstrate insulation qualifies as Class 1 or Class 2 Vapor Retarder (1 perm or less).
- Insulation must be taped with the proper tape for the insulation type and sealed at edges to achieve vapor retarder rating.
- Rater Sign Off

4E-8g_ Energy Heel: minimum R38 to outside face of exterior walls

Requirements:

- Rater Sign Off

4E-8h_ Access openings to new attics and new knee wall areas are well insulated Horizontal Attic Access = R38 min and Vertical Knee Wall Access = R23 minimum

Requirements:

- Rater Sign Off

4E-9_ Advanced air sealing techniques used

Select all that apply:

4E-9a_ Seal all attic by-passes (spot seal or spray foam entire attic floor)

4E-9b_ Access openings to new attics and new knee wall areas are weather-stripped

4E-9c_ Provide insulation wind baffle or other air barrier to block wind washing at all attic eave bays in roof assemblies with soffit vents

Requirements:

- Notes on drawings and/or specifications indicating work to be done or product to use.
- Rater Sign Off

Exceptions:

- None

Rationale:

[Thank You Sponsors - Together We Improve Homes & People's Lives](#)

- Improves energy efficiency and durability

Considerations:

- None

Resources:

- TBD

Drawing of attic access door

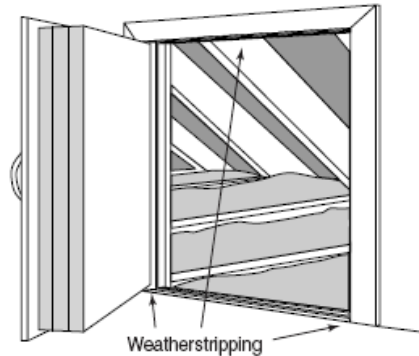

4E-10_ New Roof Built w/ Advanced Roofing Materials & Techniques.

Select all that apply:

4E-10a_ Self sealing bituminous membrane at valleys and penetrations (code required at eaves)

4E-10b_ Self sealing bituminous membrane over entire roof deck

Requirements:

- Post-installation photo

Rationale:

- 4E - 10a & 10b. Self-adhesive bituminous membrane is an excellent water barrier, which can seal around fasteners that puncture it. It is an upgrade from the more common 30# building paper. Always assume that water and moisture will get past the primary roofing material as some point, therefore, a good drainage plane is important.

4E-10c_ Metal drip edge at all roof edges

Requirements:

- Post-installation photo

[Thank You Sponsors - Together We Improve Homes & People's Lives](#)

Rationale:

- 4E - 10c. Metal drip edge
 - o Helps ensure that water drips clear of the roof rather than running down the face of the roof fascia and trim.
 - o Drainage plane above shall direct water flow onto and not behind flashing.
 - o At roof/sidewall locations, the intersecting wall siding shall terminate a minimum of 2" above roof.

4E-10d_ Metal "W" shaped valley flashing at valleys

Requirements:

- Post-installation photo

Rationale:

- 4E-10d. Metal "W" shaped valley flashing is more durable than just weaving shingles down the valley. Also, the ridge in the middle helps ensure that water from one side of the valley does not cross the valley and go up under the roofing on the opposing side.

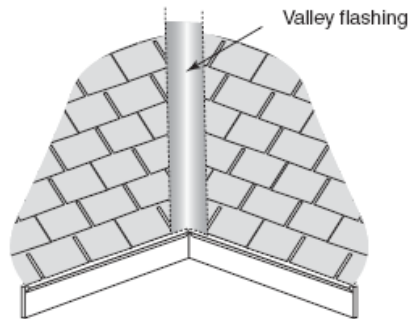

4E-10e_ Minimum 40-year roofing material (minimum 90% of roof area)

4E-10f_ Minimum 50-year roofing material (minimum 90% of roof area)

4E-10g_ Lifetime roofing material (including slate, steel, concrete, clay, etc.) (minimum 90% of roof area)

Requirements:

- Post-installation photo

Rationale:

- 4E - 10e, 10f, 10g. Longer warranties and longer life expectancy implies greater durability.

[Thank You Sponsors - Together We Improve Homes & People's Lives](#)

4E-10h_ Roofing material with ENERGY STAR Cool Roof certification (90% minimum of roof area)

Requirements:

- Post-installation photo

Rationale:

- 4E - 10h. Roofing that has the ENERGY STAR Cool Roof certification will stay cooler, and therefore contribute less to summer cooling requirements in the house. This effect is more pronounced in climates where lower insulation R-values are common, but it still has a slight benefit in Minnesota.

4E-10i_ Green roof system is installed (see Rainwater Management)

Requirements:

- Post-installation photo

Rationale:

- 4E - 10i. See Rainwater Management section for more information.
- Must follow manufacturer's specifications for installation.
- It is recommended that a structural engineer review vegetated roof design and field verify site conditions prior to, and after installation.
- A vegetated roof reduces solar heat gain on a roof as the plant material absorbs heat as well as aids in minimizing roof water runoff.

Requirements:

- Post-installation photo

4E-11_ Roof overhang

Select one:

4E-11a_ 16" to 23"4E-11b24" to 31"4E-11c32" or more

Requirements:

- Notes on drawings and/or specifications indicating work to be done or product to use.
- Post-installation photo—OR—rater verification

Exceptions:

- None

Rationale:

[Thank You Sponsors - Together We Improve Homes & People's Lives](#)

- This passive solar strategy in cold climates, if designed properly, can help shield south facing windows from direct sunlight in summer months, and will allow sunlight to enter the home when sun angles are lowest in the winter.
- Large overhangs bring water farther away from the foundation.

Considerations:

- None

Resources:

- TBD

4E-12_ Install roof gutters to discharge water 5' away from any foundation or, in limited spaces, deposit into underground pipe that carries water minimum 10' from foundation

Requirements:

- Notes on drawings and/or specifications indicating work to be done or product to use.
- Post-installation photo—OR—rater verification

Exceptions:

- None

Rationale:

- Water intrusion is a major durability concern.
- Getting water away from the foundation in the first place is a good strategy.
- In many instances, neighboring homes are close together. In this situation, provide a drainage swail (low area) to collect water and bring it beyond the front or back of any house

Considerations:

- See Section 2 - Site and Landscape for Green strategies that help ensure the water is captured for irrigation or allowed to re-absorb into the ground to recharge the aquifer.

Resources:

- TBD

4E-13_ Design and specify balanced roof ventilation system (non-vented "Hot" roofs also qualify if drawings are included to show critical details, e.g., at roof/wall intersections). (Non-vented designs must be pre-approved by building code official.)

Requirements:

[Thank You Sponsors - Together We Improve Homes & People's Lives](#)

- Do design work as described in credit description above.
- Provide notes on drawings and/or specifications describing work to be done.
- Post-construction photo—OR—rater verification

Exceptions:

- None

Rationale:

- If a vented roof is part of the overall design of the house, then it must be balanced and working properly.
- Most houses are designed to have a vented roof. Usually it is a passive system, but occasionally mechanically venting them can be an effective strategy. Regardless of the type, it is very common to find them not operating as they should. Many times the proper vent holes were not installed from the beginning. If they do exist, they have often become blocked over time from dust and dirt or carelessly installed insulation, etc.
- If roof ventilation is not working properly, the effects, include:
 - o Damage to the building structure
 - o Water leaking through the ceiling of upper rooms
 - o Wet attic insulation, which has very little R-value, and keeps the structure wet, making structural decay progress more rapidly.

Considerations:

- See Rationale above.

Resources:

- TBD - See calculator spreadsheet for balanced roof attic ventilation in checklist.

4E-14_ Implement design from 4E-13. Install-new eave vents, vent chutes, roof vents—OR—implement non-vented strategy. (Non-vented designs must be pre-approved by building code official.)

Requirements:

- Perform work described in design/specification portion of credit 4E-13.
- Post-construction photo—OR—rater verification

Exceptions:

- None

Rationale:

- See 4E-13
-

[Thank You Sponsors - Together We Improve Homes & People's Lives](#)

Considerations:

- See 4E-3

Resources:

- TBD

[Thank You Sponsors - Together We Improve Homes & People's Lives](#)

5 MECHANICALS

5PR -Prerequisites

5PR-1_ No unvented combustion units, with the exception of kitchen-type cooking devices with exhaust ventilation

Requirements:

- Combustion units including dryers, furnaces, and water heaters must vent directly from the unit through sealed and continuous ducting to the exterior of the home.
- The ducting must be rigid type, not flexible ducting
- The ducting must not have kinks or angles greater than 90 degrees
- A Worst Case Combustion Spillage Test is recommended if atmospheric combustion equipment exists in the home (see OPR-11 for details)

Exceptions:

- Gas cook tops or ranges that have ventilation (vent hood or downdraft) to the exterior are exempt
- Propane heaters which are properly connected and checked for leakage are exempt

Rationale:

- Combustion equipment can emit moisture, carbon dioxide, carbon monoxide, and toxins into the air. It is unhealthy, at best and dangerous at worst to contain these elements within the house.

Considerations:

- Flexible ducting on dryers should not be used. Lint can accumulate along the length of the ducting and can be a fire hazard.
- If the furnace and water heater vent through a chimney flue, make sure there are proper dampers and screening at the exit point.
- Check regularly the condition of the chimney to make sure animal nests are not blocking the exhaust, and that the chimney is not crushed.
- Adequate make-up air may not be present to make operation of a gas dryer, gas range, water heater, and furnace safe. Whenever air leaves the home, new air must be brought in to replace it. If this volume of air is not adequate, it can cause these appliances and equipment to backdraft carbon monoxide (see OPR-11 for further details)

[Thank You Sponsors - Together We Improve Homes & People's Lives](#)

- Operating a propane heater in a home can be dangerous. Improper operation, leaks, and faulty valves can have fatal consequences. Make sure carbon monoxide detectors are operating properly, and consider having a mechanical contractor test for leaks and overall operation.

Resources:

- See OPR-11 for details, or contact a local energy rater for performing a Worst Case Combustion Spillage Test.

5PR-2_ No equipment is permitted that intentionally produces ozone as a product rather than as an incidental by-product

Requirements:

- Equipment labels or other, which describe the equipment as ozone generators in the form of air cleaners and other ozone generating devices

Exceptions:

- Normal equipment use such as air conditioners and aerosols, which do not use CFC (chlorofluorocarbons), are allowed. CFC use has been phased out and replaced with HCFCs. HCFCs are also ozone depleting, and are discouraged. Look for new equipment that does not use CFCs or HCFCs. There are alternates such as hydrocarbon-based coolants.

Rationale:

- When ozone is breathed, it can damage the lungs and is a known asthma trigger.
- Incidental by-product is the greater effect on the environment of using these products

Considerations:

- Be aware of terminology like "energized oxygen" or "pure air" as they are indicators that the product may produce ozone

Resources:

- For more information about ozone producing equipment, visit www.epa.gov/iaq/pubs/ozonegen.html

5PR-3_ All clothes dryers must vent to the outside. Any new venting being added must be smooth, rigid duct, and must terminate at least 10' from any air intakes and any air conditioning compressor

Requirements:

[Thank You Sponsors - Together We Improve Homes & People's Lives](#)

- Dryers must vent directly from the unit through sealed and continuous ducting to the exterior of the home
- The ducting must be rigid type, not flexible ducting
- The ducting must not have kinks or angles greater than 90 degrees
- A Worst Case Combustion Spillage Test is recommended if atmospheric combustion equipment exists in the home (see oPR-12 for details)

Exceptions:

- None

Rationale:

- Venting dryer exhaust inside the house can be very harmful. It is not a healthy way to add humidity to the house if the occupants determine they need added humidity. Dryer exhaust air contains too much moisture and pollutants such as fabric lint, carbon monoxide (gas dryers), and detergent chemicals that were not fully rinsed off of the clothes.
- Minimize the number of turns a duct must take before exiting the home. Every turn a duct makes reduces airflow, which would cause the dryer to work inefficiently.
- If the dryer exhaust is too close to another air intake there is a risk that the hot moist air from the dryer will go into those intakes which are intended to be pulling in clean ambient outside air. Also, hot, moist dryer exhaust air will cause air conditioning compressors to work inefficiently.
- Note: All dryer vents should be cleaned bi-annually to prevent lint build-up.

Considerations:

- All dryer ducts collect lint. Ducts must be cleaned bi-annually to prevent fires. Non-rigid ducts including flexible metal and expandable plastic ducts can collect more lint, and can be punctured when cleaning.
- Air is drawn out of the house through the dryer when running. Have a mechanical contractor or home energy rater verify with a Worst Case Combustion Spillage Test that adequate make-up air is provided elsewhere in the home (see OPR-12 for details)
- Make sure the exhaust end of the duct, where it exits the home, is properly screened and protected from animal nests, rodent intrusion, and water infiltration

Resources:

- The Appliance411 website has helpful information about maintenance as well as diagrams for proper ducting of dryers, www.appliance411.com/faq/dryer-vent-length.shtml

5PR-4_ No air handlers or conditioning equipment shall be placed in unconditioned spaces (e.g., garage) (does not include condensers)

[Thank You Sponsors - Together We Improve Homes & People's Lives](#)

Requirements:

- Equipment must be placed in a room within the insulated building envelope
- Air handlers and other conditioning equipment must be in a location which is readily accessible for maintenance and cleaning

Exceptions:

- Un-insulated basements where heating ducts and pipes are contained are acceptable.
- If air handlers and conditioning equipment are to be located in an attic space, the attic envelope must be insulated, creating a conditioned space
- A crawl space must be treated as conditioned (insulation and air must be exchanged between the basement and crawl space, or home and crawl space) in order for equipment to be located in this area.

Rationale:

- Air handlers or conditioning equipment that is placed in unconditioned space is far less energy efficient
- Air handlers and conditioning equipment must work harder to heat or cool the air and will reduce the lifespan of the equipment

Considerations:

- Garages and unconditioned attics are especially problematic for air handlers and conditioning equipment because they can pick up dirt, dust, and pollution from car exhaust and carry it through the home.

Resources:

- The following document has extensive information about air handling equipment and ideal locations for this equipment throughout the home, www.eere.energy.gov/buildings/info/documents/pdfs/air_dist_sys_design-0782.pdf

5PR-5_ Ducts must be protected until construction (including floor finishing) is complete (protect returns and intakes)

Requirements:

- Supply and return duct outlets and inlets shall be covered to stop construction trash and dust from contaminating new duct system.
- Open ductwork must be sealed and protected with a continuous plastic covering and sealed with duct tape strong enough to keep openings sealed during construction.
- Avoid operating equipment during construction, as this draws contaminants into the system. Use a temporary source of heat during construction

Exceptions:

- None
-

[Thank You Sponsors - Together We Improve Homes & People's Lives](#)

Rationale:

- Contaminants can enter the air through ducts and cause respiratory illnesses and diseases. Once ducts are full of contaminants, it is difficult to remove airborne pollutants, and dust and particles lining the ducts.
- Some ducts, such as flexible ducting, are difficult, if not impossible to clean. It is far easier to prevent contaminants from entering a system than it is to remove them once they are in the ductwork

Considerations:

- Some ducts, such as flexible ducts, or ducts with long runs, are difficult to clean once contaminants are present. Flexible ducts are easily punctured and must be cleaned with extreme caution.
- Be careful how duct tape is affixed to walls and floors as it may make removal difficult, and damage surfaces.

Resources:

- Visit the U.S. Environmental Protection Agency website at www.epa.gov/iaq/pubs/airduct.html

5PR-6_ No power roof vents unless adequate air inlets exist

Requirements:

- No power roof vents are to be used unless adequate air inlets exist.
- Sign off from rater or HVAC contractor showing calculations meet the requirements and no other solution is practical.

Exceptions:

- If power roof vents exist, and/or if the roof form is complex, it is recommended that a professional knowledgeable in residential roof venting be consulted.
- If they are the last, best option, power roof vents can be used to augment the exhaust. They are mounted in the attic in a gable vent or through the roof deck. If they are to be used:
 - They must be installed properly as a part of a system, which includes proper air sealing of the attic floor, and adequate attic air inlets.
 - They must be inspected every four (4) months to ensure that they are working.
 - The passive inlets should be inspected every two (2) years to ensure they have not become plugged.

Rationale:

- The best method to achieve adequate ventilation is to use passive air inlets and outlets. In most situations adequate ventilation can be achieved using passive

[Thank You Sponsors - Together We Improve Homes & People's Lives](#)

strategies. When passive vents are used, they should be inspected every two (2) years to ensure they have not become plugged.

- Houses that have attics need attic ventilation to keep both sides of the roof deck the same temperature, and to prevent excessive heat build-up on the attic, which can penetrate the house, causing air cooling systems to become over burdened. Attic vents also allow moisture to escape, to prevent it from condensing within the attic, which can degrade building components and insulation.
- Power Attic Ventilators are rated in CFM. This number represents the cubic feet of air moved per minute. The higher the CFM, the more powerful the ventilator. According to the Home Ventilating Institute, to determine the correct CFM rating needed, multiply attic square footage by 0.7 (e.g., square footage (attic) x 0.7 = 1050 cfm). Look for a power ventilator rated 1050 CFM or higher.
- Adequate inlet ventilation must be sized and located properly.
- For sizing, divide the CFM rating on the power ventilator by 300 for the number of square feet of intake needed. Because most vents are rated in inches instead of feet, simply multiply the number of square feet by 144 to calculate the net free area of intake needed.
- For location, inlets should be evenly distributed in the eaves to allow air to circulate up along the bottom surface of the roof deck. On hip roofs, ridge vents should be installed along the ridge of the hip or and/or notches should be installed in the top of the common rafters where they meet the hip rafter.

Considerations:

- Power roof vents may not be installed properly and as a part of a system and can pull conditioned air from the house making the heating system or air conditioner work harder which wastes energy in the long run. With the conditioned air, there is also the risk of moisture being pulled into the attic from inside the living space of the house, which can cause degradation of building components.
- Actively drawing too much air out of the home through the use of power roof vents, can cause a negative pressure effect in the home and potentially cause combustion equipment pilot lights to extinguish, or draw carbon monoxide into the home

Resources:

- Home Ventilating Institute, www.hvi.org
- ENERGY STAR, www.energystar.gov

5PR-7_ All new ductwork must be sealed

Requirements:

- Use water-based mastic or metal tape, which is specifically intended for duct sealing. Duct Tape is NOT acceptable, as it is not long lasting.
 - Seal all connections between ducts and connections at vents and registers.
-

[Thank You Sponsors - Together We Improve Homes & People's Lives](#)

- New cold air returns are also required to be sealed

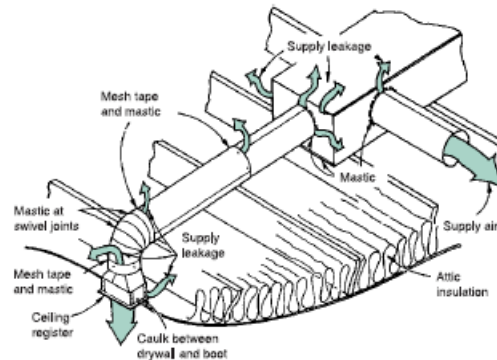

Exceptions:

- None

Rationale:

- Sealing ductwork is important for the following reasons:
- **Comfort:** Sealing and insulating ducts can help with common comfort problems, such as rooms that are too hot in the summer or too cold in the winter.
- **Health:** Sealing ducts can help improve indoor air quality by reducing the risks of pollutants entering ducts and circulating through your home. Fumes from household and garden chemicals, insulation particles, and dust can enter your duct system through leaks and can aggravate existing asthma and allergy problems.
- **Safety:** During normal operation, gas appliances such as water heaters, clothes dryers, and furnaces release combustion gases, like carbon monoxide, through their ventilation systems. Leaking ductwork in your heating and cooling system may cause backdrafting, where these gases are drawn into the living space, rather than expelled to the outdoors. Sealing leaks can minimize this risk.
- **Save money:** Leaky ducts can reduce heating and cooling system efficiency by as much as 20 percent. Duct sealing and insulating increases efficiency, lowers your energy bills, and can often pay for itself in energy savings. Plus, if you're planning to install new heating and cooling equipment, know that a well designed and sealed duct system may allow you to downsize to a smaller, less costly heating and cooling system.
- **Protect the environment:** Energy generation is one of the largest contributors to greenhouse gases. By sealing your ducts and reducing the amount of energy necessary to comfortably heat or cool your home, you can reduce the amount of air pollution generated.

Considerations:

[Thank You Sponsors - Together We Improve Homes & People's Lives](#)

- A poorly functioning, or poorly sized furnace for new duct runs can lead to inefficient operation, or worse, health issues. Have a mechanical contractor review the size of the furnace to verify that it is adequate for the number of duct runs (new and existing), and that it is functioning properly.

Resources:

- www.energystar.gov
- www.energystar.gov/index.cfm?c=home_improvement.hm_improvement_ducts

5PR-8_ New ducting MAY NOT use building cavities as part of air supply or return system

Requirements:

- New ducts are not to utilize the building envelope in lieu of sheet metal or flexible ducts. This includes NOT “panning” joists and wall cavity spaces between studs (see OPR-7 for requirements, rationale and resources)
- All new cold air returns must be ducted

Exceptions:

- None

Rationale:

- It may seem desirable at first to avoid the time and expense of installing rigid ducting, especially if the home already uses the wall and floor cavities as ductwork, however, it should never be considered because of the greater risks. Building cavities are never sealed well enough to serve as a ducting. If existing joist and wall spaces are used as air distribution supplies and returns, strongly consider installing rigid ducting.
- Kitchen and bath exhaust fans should never use wall and floor cavities as ducting without the use of sheet metal or pre-formed ducts.

Considerations:

- When return air moves through building cavities, it can pick up impurities and redistribute them throughout the house.
- There is a high risk of introducing moisture into building cavities when they are used as ducts.

Resources:

- www.homeenergy.com/archive/hem.dis.anl.gov/eehem/93/930920.html

5PR-9_ All bath fan ducting that is in unheated space shall be insulated to minimum R8

[Thank You Sponsors - Together We Improve Homes & People's Lives](#)

Requirements:

- Bath fan ducting must be insulated using either formaldehyde-free batt insulation or two-part spray applied insulation to achieve R-8. Also, the building cavity carrying the ductwork can also be insulated using rigid insulation to R-8 at all exterior walls and seams taped or sealed closed.

Exceptions:

- None

Rationale:

- Insulating ductwork that carries very moist air helps prevent condensation from occurring inside the duct during cold times of the year.
- Energy loss through ductwork can occur when passing through unconditioned space. Insulating all ductwork in unconditioned spaces is very important, especially ductwork that may not be sealed as well, like bath fan ductwork.

Considerations:

- Condensation that freezes on un-insulated ducts eventually melts and becomes moisture or water inside the joist space or wall cavity leading to mold problems.
- Oftentimes, water leaking through a bath fan is not a roof leak, but rather condensation leaking through the fan. It can diminish the lifespan of the fan, as well as present a fire hazard.

Resources:

- Visit www.energytrust.org/TA/hes/weatherization/attic.html

5PR-10_ All new cooling and heating equipment must be installed with a programmable thermostat AND it must be programmed

Requirements:

- A receipt, specification page, or photograph of the programmable thermostat
- Educate homeowner on how to properly set the thermostat—most homeowners do not know how to properly set a programmable thermostat, rendering the energy saving potential useless.
- Make sure the thermostat has an ENERGY STAR label.

Exceptions:

- None

Rationale:

- A programmable thermostat saves energy when programmed properly to set back temperatures during sleeping and while away during the day.

[Thank You Sponsors - Together We Improve Homes & People's Lives](#)

- In winter months, set away or sleeping temperatures cooler than desired when present. In summer months set the away temperatures warmer than desired when present.

Considerations:

- Most homeowners do not know how to properly set a programmable thermostat, rendering the energy saving potential useless.

Resources:

- <http://www.energystar.gov>

5PR-11_ No new air handling equipment shall be installed in a garage. If existing, it must be in a room sealed off from automobile emissions.

Requirements:

- A visual inspection is required to verify that no air handling equipment, or return air is provided in the garage.

Exceptions:

- If existing equipment HVAC equipment is in the garage, an insulated sealed room with a sealed door must be built around it to overcome the below risks.

Rationale:

- Since the garage is outside of the conditioned envelope of the house, HVAC systems that are in the garage run less efficiently.
- Equipment and return air provided in the garage can pick up contaminants and distribute them throughout the home

Considerations:

- When air handling equipment is in the garage there is great risk of garage toxins getting into the air distribution system and spreading throughout the house.

Resources:

- Home Ventilating Institute, www.hvi.org

5PR-12_ Remember to address Worst Case Combustion Spillage (WCCS) and Fresh Air Supply (FAS) when designing and installing any HVAC related equipment (see OPR-12)

Requirements:

- Notes on drawings and/or specifications indicating work to be done or product to use.
- Post-installation photo—OR—rater verification

[Thank You Sponsors - Together We Improve Homes & People's Lives](#)

Exceptions:

- None

Rationale:

- Prevents creation of back drafting conditions
- Prevents interior conditioned air from being used for combustion air.

Considerations:

- None

Resources:

- TBD

5A -Ventilation and Fresh Air for Occupants

Proper ventilation is extremely important in homes. Without the help of mechanical ventilation it is not possible to achieve the level of indoor air quality throughout the year that is considered healthy for the occupants or the home itself. This becomes even more relevant when we build to today's standards, which require that homes are built more airtight, and energy efficient than ever before. The strategies described below help ensure optimal indoor air quality is maintained and long-term performance and durability of building components is not compromised.

5A-1_ Design and install a whole house ventilation system in accordance with SECTION N1104 MECHANICAL VENTILATION SYSTEMS of the 2009 Minnesota Residential Energy Code

Requirements:

- Total ventilation rate (CFM) = (0.02 x square feet of conditioned space) + [15 x (number of bedrooms +1)]
- Continuous ventilation rate shall be a minimum of 50% of the total ventilation rate, but not less than 40 cfm.
- See Minnesota Rules, Chapter 1322 Residential Energy Code for additional requirements and exceptions.

Rationale:

- Note: Under this (2007 proposed) Minnesota Residential Energy Code, remodels on some homes will require a whole house mechanical system, and remodels on others will not. Also, in recent years, proper whole house ventilation has come to be understood as a very important element in a systems approach to Green building. Hence, regardless of whether the whole house ventilation system is required by code, to be fair to all remodel projects, GreenStar will award points equally for such a system in any remodel project.

[Thank You Sponsors - Together We Improve Homes & People's Lives](#)

- Whole house ventilation systems include balanced systems, energy recovery ventilation, and heat recovery ventilation. All have their pros and cons, therefore consult with a mechanical contractor or engineer on the best system for a home.

Considerations:

- Balanced systems, unlike ERVs or HRVs, do not temper the air before it enters the home requiring more energy to heat and cool the new air.

Resources:

- Minnesota Rules, Chapter 1322 Residential Energy Code, visit www.eere.gov for more information about whole house ventilation systems

5A-2_ If no air exhaust already exists, install air exhaust system in any bathroom, kitchen, or laundry room. Must install ENERGY STAR equipment, ≤ 1 sone, proper CFM, and smooth rigid duct (if kitchen > 1 sone is acceptable)

Select one:

- 5A-2a_ 1 room
- 5A-2b_ 2 rooms
- 5A-2c_ 3 or more rooms

Requirements:

- Every bathroom and kitchen must be equipped with an air exhaust system. Other rooms that have the potential for high moisture levels or VOC levels, based on how they are used, should also have an air exhaust system.
- Typical air exhaust systems include the following.
 - Exhaust fan, which exhausts to the exterior.
 - System in which the exhaust duct is incorporated into a central heat recovery ventilator and fresh air supply.
- Any exhaust system that is installed must exhaust air to the outdoors with a smooth rigid duct for optimal efficiency. Non-smooth ducts restrict airflow.
- For kitchens:
 - 100 cfm minimum is recommended.
 - Range hoods are most common and typically most effective, however standard bathroom exhaust fans can also be used effectively when a range hood may be difficult to install.
 - Kitchen fans 75 cfm or smaller can be no louder than 2.0 sones and move a minimum of 1.4 cfm/watt. Fans 76 cfm or larger must be no louder than 1.5 sones and move a minimum of 2.8 cfm/watt. (EC, 41.1)
- Intentional make-up air system is required for any kitchen exhaust fan that exceeds 150 cfm.

[Thank You Sponsors - Together We Improve Homes & People's Lives](#)

- Check the fan specifications to be sure it is wired properly and rated for installation in the location you intend to put it.
- Look for a fan with the highest CFM/watt rating.

Exceptions:

- None

Rationale:

- When moisture levels in the home are too high it degrades finishes and building materials. It also creates a condition that is conducive to mold growth, which can be a serious health hazard.

Considerations:

- A Worst Case Combustion Spillage Test is recommended if there are atmospherically venting appliances or appliances with a constant pilot such as an antique stove in the home. This test ensures that any combustion equipment or appliances are not backdrafting into the home when bath and kitchen vents are turned on. Combustion spillage can leak contaminants into the home, including carbon monoxide.

Resources:

- ENERGY STAR, www.ENERGY STAR.gov/index.cfm?c=vent_fans.pr_vent_fans
- Toolbase, www.toolbase.org

5A-3_ If any non-ENERGY STAR-rated fan already exists in any bathroom, kitchen or laundry room, replace it with ENERGY STAR fan, ≤ 1 sone. Proper CFM and smooth rigid duct required (if kitchen, > 1 sone is acceptable).

Select one:

- 5A-3a_ 1 room
- 5A-3b_ 2 rooms
- 5A-3c_ 3 or more rooms

Requirements:

- Provide a fan with the highest CFM/watt rating.
- Rationale:
- Non-ENERGY STAR-rated fans typically use a lot of electricity relative to how much air they move. Replacing them with an ENERGY STAR-rated fan will save energy, and will have a net cost savings and a net benefit to the environment in the long run.

Considerations:

- Even though a fan may be operating properly, a noisy fan may not be used as much as a low noise (low sone) fan.
-

[Thank You Sponsors - Together We Improve Homes & People's Lives](#)

- The embodied energy of replacing an operable bath fan is far outweighed by the energy savings of a new ENERGY STAR fan.
- Resources:
- ENERGY STAR, www.ENERGY STAR.gov/index.cfm?c=vent_fans.pr_vent_fans
- Energy Federation Incorporated, www.efi.org

5A-4_ Install automatic controls on any exhaust fan in any bathroom or laundry room

Select one:

- 5A-4a_ 1 room
- 5A-4b_ 2 rooms
- 5A-4c_ 3 rooms
- 5A-4d_ 4 or more rooms

Requirements:

- Various automatic controls, including consolidating the fan and light switch, manual timers, programmable timers, motion sensors, and dehumidistats are all available to help ensure exhaust fans are run optimally.

Exceptions:

- None

Rationale:

- Typically, if the fan is on its own switch it is not convenient for the occupants of the house to turn the fan on and off at times that contribute to optimal indoor air quality. A good rule of thumb is for fans to at least be run when the room is occupied, and typically they should run for an extended period of time after the occupant has left the room.
- To choose the best controls to work in concert with the other ventilation systems in your house it may be advisable to consult with a knowledgeable professional.

Considerations:

- Make sure the most appropriate automatic control is added to the fan and light switch. Different types may be frustrating based on the occupant's use of the space.
- Consult with an electrician as to the most appropriate controls for the home and occupant

Resources:

- ENERGY STAR: www.ENERGY STAR.gov/index.cfm?c=vent_fans.pr_vent_fans
- Energy Federation Incorporated: www.efi.org

[Thank You Sponsors - Together We Improve Homes & People's Lives](#)

5A-5_ Install garage exhaust fan that is ENERGY STAR-rated and runs continuously at minimum 25 CFM OR If it has intermittent operation (e.g., controlled by a motion sensor or programmable timer). 100 CFM is required (attached garage only).

Requirements:

- A Minimum of 100 sq. in. of net free vent area is required for every 100 sq. ft. of floor area in the storage room. No combustion or HVAC equipment shall be in the garage.
- Exceptions:
- An optional, but recommended practice is to store products that are highly poisonous and/or high VOC and/or combustible in a locked storage room, which is adequately vented directly to the outdoors.

Rationale:

- Providing continuous fresh air to an attached garage can minimize the amount of contaminants entering the home. Instead of drawing air from the garage into the home through leaks, cracks, or doors, the air is instead drawn out

5A-6_ Check air filter hardware for tightness and correct if leaks are detected

Requirements:

- Any and all air filters in the air distribution system need to be seated tightly so that no air leaks past them or out of the system at that location.

Exceptions:

- None

Rationale:

- Air filter locations on air handlers are notorious for leakage.
- If the air filter hardware is not airtight, the air filter will not be able to clean the air effectively, and the whole system will not run as efficiently as it should.

Considerations:

- No air filter assembly can be entirely airtight, but improving the airtightness can help a system run more efficiently as well as keep particulates out of the filtering system.
- Anytime changes are made to the mechanical system (except for changing a filter), a mechanical contractor should be consulted to make sure no hazards are being introduced.

Resources:

- www.ashrae.org
- www.epa.gov/iaq/schooldesign/hvac.html

[Thank You Sponsors - Together We Improve Homes & People's Lives](#)

5A-7_ High efficiency whole house fan installed with R-42 minimum insulated cover (open windows and/or doors to prevent backdrafting)

Requirements:

- Attic ventilation must provide at least one square foot of net free vent area per 750 cfm of fan airflow ($CFM = \text{Whole House Fan ACM Capacity} \times \text{Volume of House}$).
- Whole house fan shall be installed with an insulated cover. A cover shall be constructed to air seal and insulate whole house fan.
- Homeowner shall be instructed to remove cover before operating the fan and replace cover during seasons when not in use.
- Instructions for whole house fan must be included in the Homeowner User's Manual.

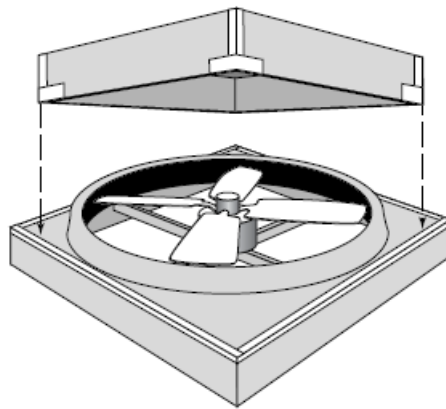

A low-cost insulated whole house fan cover should be used during the off season.

Exceptions:

- None

Rationale:

- A high efficiency whole house fan can be used to draw a lot of air through the house using the windows and doors as air inlets.
- During the cooling season, it can often be used at night to bring in cool air and cool the house down for less cost than running the air conditioner.

Considerations:

- Whole house fans can potentially cause dangerous backdrafting of atmospherically vented combustion appliances. It is very important for windows and/or doors to be

[Thank You Sponsors - Together We Improve Homes & People's Lives](#)

open when running such a fan to prevent this (see OPR-12 for Resources for a Worst Case Combustion Spillage Test).

- Insulation that is loose, such as cellulose or blown fiberglass can become disturbed during generation of fan or in removal of fan cover. Care should be taken in instructing the owner of the need to restore insulation as needed.

Resources:

- Energy Federation Incorporated: www.efi.org

5A-8_ Heat recovery ventilator (HRV) installed

Requirements:

- An HRV uses the air that is being exhausted to either pre-heat or pre-cool the incoming fresh air.

Rationale:

- A heat recovery ventilator (HRV) can save energy and heating costs by pre-heating or pre-cooling incoming fresh air with warm or cool air, which is being exhausted.
- An HRV can help lower humidity in the home during the winter months.

Considerations:

- An HRV does not transfer any of the humidity back into or out of the home.
- An HRV can dry a house more than may be comfortable, possibly requiring the addition of a humidification system.

Resources:

- Energy Federation Incorporated, www.efi.org

5A-9_ Energy recovery ventilator (ERV) installed

Requirements:

- An ERV is very similar to an HRV, however, in addition to the transfer of some of the heated or cooled air from the outgoing air to the incoming air, some of the humidity is also transferred.

Exceptions:

- None

Rationale:

[Thank You Sponsors - Together We Improve Homes & People's Lives](#)

- An energy recovery ventilator (ERV) can save energy and heating costs by pre-heating or pre-cooling incoming fresh air with warm or cool air, which is being exhausted. An ERV can also help balance humidification to the home in the winter.

Considerations:

- Not all ERVs are rated for the extremely cold weather that occurs in Minnesota, so special attention should be given to this issue.
- Resources:
- Energy Federation Incorporated, www.efi.org

5A-10_ All outdoor air intakes for ventilation located at least 10' away from air exhaust outlets and areas where vehicles may be idling

Requirements:

- Field verification is required.

Exceptions:

- None

Rationale:

- Drawing air into the home from a location near where air is exhausted from the home can bring unwanted moisture, odors, and fumes along with it. Placing intakes a minimum of 10' from exhaust air (including potential car exhaust) helps keep incoming air cleaner.

Considerations:

- Carbon monoxide could be one of the most harmful of all possible contaminants drawn into the home if air intakes are located too close to exhaust or locations where cars may be idling.

Resources:

- www.carbonmonoxidekills.com

5A-11_ Install large media filter

Requirements:

- Install a clean filter, with the direction of the airflow clearly noted, a minimum of every three (3) months.

Exceptions:

- None

[Thank You Sponsors - Together We Improve Homes & People's Lives](#)

Rationale:

- A large media filter is useful if a furnace is older or not an efficient model. It will capture dust, dust mites, and other large particulate matter.

Considerations:

- Have furnace maintained on an annual basis. Verify with the HVAC contractor performing the maintenance to make sure a large media filter is appropriate for the particular furnace, and for its proper installation.
- Older furnaces can lose significant efficiency and airflow if a HEPA or better performing air filter (with an MERV of 8 or higher) is used.

Resources:

- www.ashrae.org

5A-12_ Install high performance air filter

Select One:

5A-12a_ Use HEPA or better-performing air filter with MERV rating of 12 to 15 (greater than 1" thick pleated filters preferred)

5A-12b_ Use HEPA or better-performing air filter with MERV rating of 16 or higher (greater than 1" thick pleated filters preferred)

Requirements:

- Air filters/air cleaner with minimum of 30% dust spot efficiency (e.g., pleated filters, MERV rating of 12 or higher).
- Ozone generators are not permissible as air cleaners.
- Filter, 2" pleated or better.
- Install a clean filter, with the direction of the airflow clearly noted, a minimum of every three (3) months.

Exceptions:

- None

Rationale:

- A HEPA or better performing air filter removes significant amounts of pollutants from the air. A HEPA filter can improve indoor air quality especially if the home's occupants have allergies—especially to dust.
- A separate room air purifier may be needed to add additional air filtration.

Considerations:

[Thank You Sponsors - Together We Improve Homes & People's Lives](#)

- Older furnaces can lose significant efficiency and airflow if a HEPA or better performing air filter (with an MERV of 8 or higher) is used. Verify if the furnace can operate efficiently with a high efficiency filter.

Resources:

- www.ashrae.org

5A-13_ Install UV light filter in return air duct and at the air conditioning “A” coil

Requirements:

- The UV light filter must be installed on a furnace that can accommodate this modification.

Exceptions:

- None

Rationale:

- A UV light filter can kill bacteria and mold spores before they have the opportunity to re-enter the duct system and become airborne
- A UV light filter is particularly beneficial to occupants who suffer allergies.

Considerations:

- Make sure the furnace can be equipped with a UV light filter.
- UV light can damage vision if the light is exposed directly to the naked eye. Make sure the light is off before installation or any maintenance occurs.

Resources:

- See Energy Federation Incorporation: www.efi.org

5A-14_ Install sub-slab soil gas/moisture vent system, passive or active

Requirements:

- If test indicates greater than 4 picocuries per liter radon concentration, remodeler must follow EPA guidelines to reduce radon levels.
- If radon levels are less than 4 picocuries, this type of a system is recommended because a) radon levels often change over time, and b) the vent helps keep basements dry, which is usually one of the largest problems with utilizing basement space.

Exceptions:

- None

[Thank You Sponsors - Together We Improve Homes & People's Lives](#)

Rationale:

- Minnesota GreenStar steps:
 - Determine U.S. EPA radon area by consulting U.S. EPA Radon Zone Maps (<http://www.epa.gov/radon/zonemap/minnesota.html>)
 - Install Radon-resisted features (active or passive sub-slab depressurization system) in all homes in U.S. EPA radon Zone 1 and 2 radon areas*

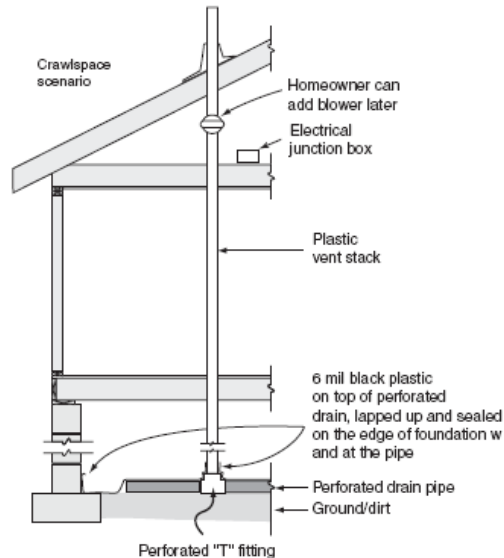

* Provide owners of homes in U.S. EPA Zone 1 and Zone 2 radon areas with two (2) radon test kits designed for 49-hour exposures, including instructions for use and guidance for follow-up actions to testing results

Considerations:

- None

Resources:

- www.epa.gov/radon/pubs/citguide.html

5B -Moisture and Relative Humidity

[Thank You Sponsors - Together We Improve Homes & People's Lives](#)

Overall Moisture and Relative Humidity Requirements

Indoor moisture and relative humidity is complex and extremely important to a home's occupant health. There are many variables to consider and it is VERY important to consider the house as a whole system when addressing moisture and relative humidity. This point cannot be emphasized enough when remodeling existing homes as there are such a wide variety of building assemblies, heating and cooling systems, air supply and air circulation systems, etc. When designing and/or installing any type of indoor humidification control system, it is highly recommended that a knowledgeable professional is consulted.

There is a certain amount of general information that is worth including here to help the users of Minnesota GreenStar approach this issue. While some amount of moisture in the air is necessary for occupant comfort and health, too much contributes to the growth of mold and dust mites, which can pose serious health risks. Key scientific concepts related to this issue include the following.

- Relative Humidity (RH) is the amount of water vapor in the air relative to the maximum that the air could hold at that given temperature. Any body of air could be cooled in order to cause the water vapor it contains to condense (become liquid). The temperature at which this happens is called the dew point.
- It is important to avoid situations in buildings where the conditions are right for air to reach its dew point and for water to condense anywhere on interior surfaces or within the building assembly.

The optimum relative humidity level for personal comfort and ideal building durability are often at odds with one another. People typically feel comfortable between 30% and 60%. RH levels of 60% or above are considered to be in the risk zone for mold and dust mite growth.

For the building, an optimal RH varies depending on the outside temperature and ultimately the dew point. It also varies from building to building depending on the quality of construction and the materials used. Condensation will typically occur on the coldest surface in the home first, and given current technology, this is almost always the windows. Therefore, the windows are usually a good indicator of acceptable RH levels in any given house at any given time. If condensation is occurring, the RH level is getting outside of the acceptable range for the building, regardless of occupant comfort.

The following table gives some fairly safe rule of thumb guidance on recommended indoor RH levels for various outside temperatures.

Outside temperature (0° F)	Recommended Indoor RH
+20° and above	35% to 40%
+10°	30%
0°	25%
-10°	20%
-20°	15%

[Thank You Sponsors - Together We Improve Homes & People's Lives](#)

It is a common misconception of homeowners that they can just add a humidifier to increase the humidity of their home in the coldest, driest months to meet their comfort needs. Usually extremely low RH levels are intermittent and cycle with the outside temperature. Often the best approach is to try to just tolerate the extremely low RH levels that occur on occasion rather than risk building durability and mold issues that are associated with RH levels that exceed what is safe for your house.

As stated previously, adding humidity in the home should only be done with extreme caution. Homeowners that find it is not possible to raise the RH level of their home to a comfortable level without condensation occurring on the coldest surfaces (their windows), should work with a knowledgeable building professional to design and implement improvements to their home, which will allow their house to accommodate RH levels that are more comfortable to them. Usually there are enough improvements that can be made to the home itself that will both raise the natural RH level of the home as well as allow the home to operate safely at that level without adding a humidifier. Typical home improvements that fall into this category include the following.

- Window upgrades. Addition of storm windows, upgrading to insulated glazing, etc. See also Sections 3 and 4 of the GreenStar Remodeling Program.
- Sealing air leaks. Attic bypasses, wall penetrations, leaks through and around windows and doors, etc. See also Sections 3 and 4 of the GreenStar Remodeling Program.
- Installation of ERV. In Minnesota winters, these help retain indoor RH and temperature while bringing in fresh air. See also Section 5 of the GreenStar Remodeling Program.

Overall Moisture and Relative Humidity Resources

- www.humidifierinformation.com
- Mechanical and Electrical Equipment for Buildings, Eighth Edition
Benjamin Stein and John S. Reynolds
©1992 Wiley and Sons, Inc.

5B-1_ Install temperature and humidity sensors and record indoor/outdoor data for two weeks prior to project beginning and one year after project completion

Requirements:

- Indoor and outdoor RH and temperature levels measured on all levels of the home, every 12 hours for two (2) weeks to establish a pattern of humidity levels.

Exceptions:

- None

Rationale:

[Thank You Sponsors - Together We Improve Homes & People's Lives](#)

- Individual humidity level measurements do not give an adequate indication of the humidity situation in a home. Much more data is necessary to gain an understanding of how the levels may change over time. This data is essential to remain aware of humidity levels throughout the occupancy of the house and to know if corrective action is necessary at any given time.
- People that are more aware of the RH levels of their home tend to be better at managing the indoor environmental quality.

Considerations:

- None

Resources:

- Contact the mechanical contractor involved with the project

5B-2_ Installation of new (or replacement of old) dehumidifier with ENERGY STAR-rated dehumidifier equipped with humidity sensor

Requirements:

- Install stand-alone dehumidifier with humidity sensor in areas of the house that are most susceptible to high humidity levels—AND/OR—install system integrated dehumidification system into forced air system.
- Homeowner must sign-off to indicate that they have received education for dehumidification system.

Exceptions:

- None

Rationale:

- Given the risks associated with high humidity levels in the home, installing a dehumidifier in the most susceptible areas of the house (e.g., basement) typically adds extra protection against unsafe high humidity levels.

Considerations:

- The risks associated with dehumidifying the air TOO much are minimal and typically adding a de-humidification system that is ready to run if and when the need arises, is encouraged.

Resources:

- www.ENERGY STAR.org

[Thank You Sponsors - Together We Improve Homes & People's Lives](#)

5C- HVAC DISTRIBUTION STRATEGIES

5C-PR1_ All new flex duct pulled tight (no pinches)

Requirements:

- Any flexible ducting must have smooth, even lines, angles must not exceed 90 degrees (no “U” shapes) and must minimize duct runs. There must be no pinching or bunching (extra material), or areas where the airflow is restricted.
- Provide photographs showing flexible ducting

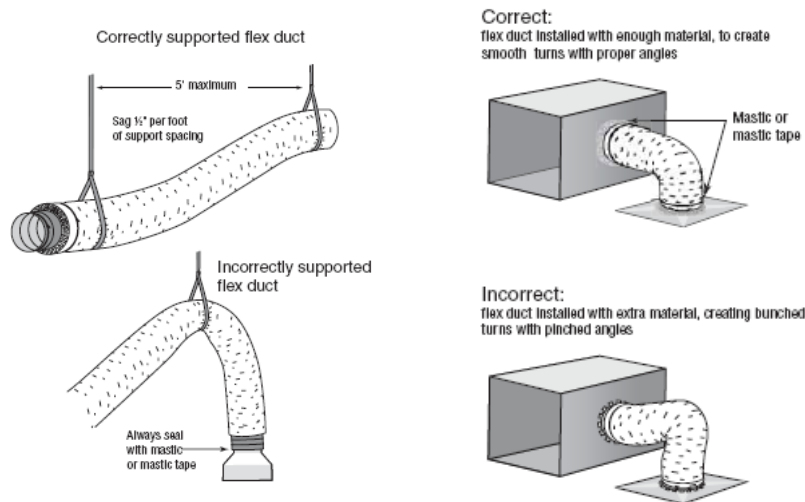

Exceptions:

- None

Rationale:

- Flexible duct that is pulled tight permits maximum airflow.
- Pinched ducts restrict airflow and reduce the efficiency of mechanical equipment.

Considerations:

- Restricted airflow can reduce the efficiency of equipment.
- Pinched or excessive duct runs can collect dust and particulates, blocking airflow.
- Dryer vents with flexible ducting are NOT recommended - they can be a fire hazard.

Resources:

- TBD

[Thank You Sponsors - Together We Improve Homes & People's Lives](#)

5C-PR2_ All ductwork in unconditioned space insulated (Attics = R-30 minimum) (Walls = R10 minimum)

Requirements:

- Ducting in unconditioned space must be insulated using either formaldehyde-free batt insulation or two-part spray applied insulation to achieve R-values indicated above. Also, the building cavity carrying the ductwork can be insulated to qualify.

Exceptions:

- None

Rationale:

- Cold and hot air from the unconditioned space can enter the home through the ductwork. The closer in temperature the ductwork is to the conditioned part of the house, the less likely it is to transfer heat or cold to the space.

Considerations:

- None

Resources:

- TBD

5C-PR3_ No building cavities can be used as ductwork (i.e., no panning of joist or wall cavities for duct supply or return)

Requirements:

- See 5-PR8

Exceptions:

- See 5-PR8

Rationale:

- See 5-PR8

Considerations:

- See 5-PR8

Resources:

- See 5-PR8

[Thank You Sponsors - Together We Improve Homes & People's Lives](#)

5C-1_ Perform duct blaster test for AIR LEAKAGE TO THE OUTSIDE.

Select one:

- 5C-1a_ Air leakage < 8% of air handler flow.
- 5C-1b_ Air leakage < 5% of air handler flow.
- 5C-1c_ Air leakage < 3% of air handler flow.

Requirements:

- Refer to the Residential Energy Services Network (RESNET) “2006 Mortgage Industry National Home Energy Rating Systems Standards” and the “RESNET Formal Interpretation 2006-002” for testing procedures.”
- A duct blaster test must be performed by energy rater and energy rater document must be provided. Note exceptions below.
- This test can be performed at the end of construction, however it is recommended that it be performed before wall finishes are installed. Results are typically better since it is easier to seal off the ducts where they terminate at this stage of construction.

Exceptions:

- Companies that perform aerosol duct sealing should contact GreenStar if they wish to become qualified to provide duct leakage testing and documentation.
- They will need to demonstrate that their testing equipment meets GreenStar Quality Standards and that they fully understand the testing procedures adopted by GreenStar.
- Periodic spot checking of their testing results may be done by GreenStar to verify the quality of their testing.

Rationale:

- Leaky ducts reduce the efficiency of mechanical equipment. Sealing leaky ducts with butyl tape (not Duct Tape) can increase efficiency. Acceptable Tape is UL 181 listed.
- Sealing leaky ducts can reduce airborne contaminants from infiltrating the ductwork and into the air.

Considerations:

- None

Resources:

- www.natresnet.org/standards/mortgage/RESNET_Mortgage_Industry_National_HERS_Standards.pdf
- www.natresnet.org/standards/mortgage/interpretations/duct_test.pdf

[Thank You Sponsors - Together We Improve Homes & People's Lives](#)

- www.southface.org/web/Resourcesandservices/publications/factsheets/22blowdoor.pdf

5C-2_ Perform duct blaster test for TOTAL DUCT LEAKAGE.

Select one:

- 5C-2a_ Air leakage < 35% of air handler flow.
- 5C-2b_ Air leakage < 25% of air handler flow.
- 5C-2c_ Air leakage < 15% of air handler flow.

Requirements:

- Refer to the Residential Energy Services Network (RESNET) “2006 Mortgage Industry National Home Energy Rating Systems Standards” and the “RESNET Formal Interpretation 2006-002” for testing procedures.”
- A duct blaster test must be performed by energy rater and energy rater document must be provided. Note exception below.
- This test can be performed at the end of construction, however it is recommended that it be performed before wall finishes are installed. Results are typically better since it is easier to seal off the ducts where they terminate at this stage of construction.

Exceptions:

- Companies that perform aerosol duct sealing should contact GreenStar if they wish to become qualified to provide duct leakage testing and documentation.
- They will need to demonstrate that their testing equipment meets GreenStar Quality Standards and that they fully understand the testing procedures adopted by GreenStar.
- Periodic spot checking of their testing results may be done by GreenStar to verify the quality of their testing.

Rationale:

- Leaky ducts reduce the efficiency of mechanical equipment. Sealing leaky ducts with butyl tape (not Duct Tape) can increase efficiency. Acceptable Tape is UL 181 listed.
- Sealing leaky ducts can reduce airborne contaminants from infiltrating the ductwork and into the air.

Considerations:

- None

[Thank You Sponsors - Together We Improve Homes & People's Lives](#)

Resources:

- www.natresnet.org/standards/mortgage/RESNET_Mortgage_Industry_National_HERS_Standards.pdf
- www.natresnet.org/standards/mortgage/interpretations/duct_test.pdf
- www.southface.org/web/Resourcesandservices/publications/factsheets/22blowdoor.pdf

5C-3_ Ductwork

Select all that apply:

5C-3a_ All newly added ductwork kept in conditioned space and interior walls. Ductwork allowed in vaulted ceiling provided it stays on the conditioned side and the minimum R-values are still met.

Requirements:

- No new ducts are allowed in exterior walls. If perimeter ventilation is desired, terminate ducts at the floor or ceiling before reaching the wall.
- Create a conditioned wall, ceiling, or floor chaise so ductwork is in insulated cavity.

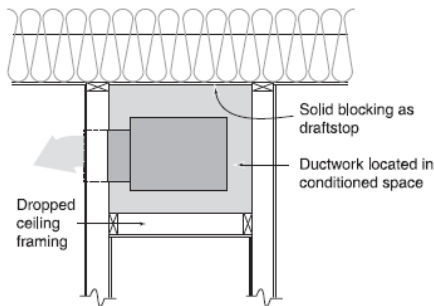

Exceptions:

- None

Rationale:

- When ductwork is kept inside the insulated envelope, the HVAC system operates much more efficiently since there is less lost during heating and cooling. Furthermore, what is lost from the mechanical system is still captured within the house.

[Thank You Sponsors - Together We Improve Homes & People's Lives](#)

Considerations:

- None

Resources:

- TBD

5C-3b_ Design appropriate duct and mechanical system using ACCA Manual D

Requirements:

- Airflow for each duct measured and balanced to within 15 cfm of design value.
- Multiple return ducts or transfer grills.
- Each bedroom shall have a dedicated return duct, or for homes with no return ducts located in bedrooms, all supply air shall have a direct path back to a return grille even when doors are closed. This path shall be through transfer grills.
- Houses with undercut doors to bedrooms do not qualify for these points.
- Provide manual D to Minnesota GreenStar at plan review.

Exceptions:

- None

Rationale:

- When ducts are sized appropriately for a home, the mechanical systems operate at their optimum performance standards.
- When Manual D calculations are combined with additional ACCA calculations such as Manual J and Manual S, the mechanical systems work together to their ideal specifications
- Appropriately sized ducts reduce energy consumption as right amounts of air (whether heating or cooling) are moved through them.

Considerations:

- None

Resources:

- www.energy.ca.gov/efficiency/qualityhomes/procedures.html

5C-3c_ All supply duct take-offs spaced 6" apart minimum

Requirements:

- All supply duct take-offs shall be spaced at least 6" apart from each other with no duct take-offs originating from the cap of the supply plenum.

[Thank You Sponsors - Together We Improve Homes & People's Lives](#)

- No duct take-offs within 6” of supply plenum cap
- Notes on drawings and/or specifications indicating work to be done or product to use.
- Post-installation photo—OR—rater verification

Exceptions:

- Junction boxes with 4 take-offs or less are excluded.

Rationale:

- Improves system efficiency.
- When duct take-offs are closer less than 6” apart, there is typically inadequate air flow into each of them.

Considerations:

- None

Resources:

- None

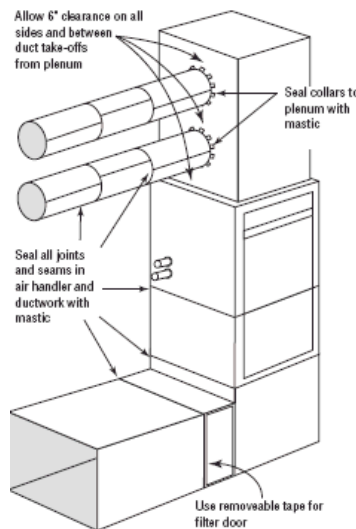

5C-3d_ All ductwork is rigid (no flex duct used anywhere)

Requirements

- For this elective credit, all new ductwork shall be made of rigid duct materials (i.e. sheet metal, duct board, etc.).
- Rater sign off at pre-drywall inspection

[Thank You Sponsors - Together We Improve Homes & People's Lives](#)

Exceptions:

- None

Rationale:

- Rigid ductwork allows better air flow.

Considerations:

- Restricted airflow can reduce the efficiency of equipment.
- Pinched or excessively long duct runs can collect dust and particulates, blocking airflow.
- Dryer vents with flexible ducting are NOT recommended - they can be a fire hazard.

Resources:

- TBD

5C-3e_ Upgrade existing duct system by replacing with rigid ductwork and sealing with mastic, aerosol duct sealant, or equivalent

Requirements:

- No Duct Tape or similar to be used as a sealant.
- New ducts must be rigid, no flex, with all connections and joints sealed with mastic or aerosol duct sealant.

Exceptions:

- None

Rationale:

- Rigid, sealed ducts perform better and are easier to maintain long-term compared to flexible ducts or “panned” joists.
- Rigid ducts hold up better to cleaning methods
- Sealing rigid ducts prevents air leakage and heightens efficiency of mechanical units.

Considerations:

- If installing new rigid ducts requires the demolition of nearly all interior wall surfaces, and demolition was not anticipated, the benefits of new ducts needs to be weighed against the drawbacks of demolition waste, repair, and finishing of the home.

Resources:

- TBD

[Thank You Sponsors - Together We Improve Homes & People's Lives](#)

5C-3f_ & 5C-3g_ Existing duct trunk lines in unconditioned space insulated to R10 or R30

Requirements:

- Existing ducting in unconditioned space must be insulated using either formaldehyde-free batt insulation or two-part spray applied insulation to achieve R-10. Also, the building cavity carrying the ductwork can also be insulated using rigid insulation to R-10 at all walls and seams taped or sealed closed.

Exceptions:

- None

Rationale:

- Energy loss through ductwork can occur when passing through unconditioned space. Insulating all ductwork in unconditioned space is very important.
- If existing ductwork is uninsulated and unsealed in unconditioned space, significant energy, moisture and particulate transfer may occur.

Considerations:

- None

Resources:

- TBD

5C-3h_ & 5C-3i_ Furnace or boiler located to minimize length of duct runs or waterlines

Requirements:

- Home plan with diagram and measurements showing furnace location and its optimal location for minimizing duct runs.

Exceptions:

- None

Rationale:

- A centralized furnace to minimize duct runs can save energy as the ideal temperature can be reached evenly throughout the house.
- Paired with a zoned heating system, a centralized location can reduce heating bills.

Considerations:

- Locating a new furnace or relocating an existing furnace can be a considerable expense depending on the amount of ductwork, wiring, make-up air, and other air handling equipment that is connected to the furnace.

[Thank You Sponsors - Together We Improve Homes & People's Lives](#)

- If a furnace is located on the main living level, a central location may not be feasible.
- If a finished basement is desired in the future, homeowner education may be needed to explain the importance of a centrally located mechanical room.

Resources:

- None

5C-3j_ Seal all new ductwork with mastic

5C-4_ Properly designed ductless system installed in home other than bath fan, kitchen hood, and make-up air

Requirements:

- Ductless mini-split heat pump systems also qualify for these points.

Exceptions:

- Bath fans, kitchen hoods, and make-up air always require ducts.

Rationale:

- In some situations with small homes it is possible to have a centrally located furnace that requires no ducts.
- Ductless systems allow for easier zoning of areas, floors, or rooms of home, so better energy efficiency is achieved.

Considerations:

- This credit is not meant to encourage the installation of fireplaces or space heaters.

Resources:

- www.efi.org

5C-5_ Seal existing HVAC cabinet seams, and all seams of plenums and ductwork with mastic. Cabinet doors should be gasketed.

Requirements:

- Provide evidence that the HVAC cabinet seams have been sealed
- Provide evidence that the HVAC cabinet seams warranted sealing, and that they were not pre-sealed by the manufacturer

Exceptions:

[Thank You Sponsors - Together We Improve Homes & People's Lives](#)

- Some cabinet doors cannot be gasketed

Rationale:

- Sealing HVAC cabinets reduces air and contaminant infiltration or ex-filtration
- Sealing HVAC cabinets with new gaskets can improve efficiency

Considerations:

- Make sure the furnace is evaluated beforehand and qualifies to be sealed. A Worst Case Combustion Spillage Test should be performed to make sure no potential issues are involved with gasketing the cabinet seams

Resources:

- www.energystar.gov

5C-6_ Rooms and zones have balanced airflow. +/- 3 pascals relative to the outdoors or adjacent rooms caused by any single or combination of fans or blowers.

Requirements:

- Any closed room, except those listed, without a return air duct must have the door undercut 1”
- Net free opening size must be a minimum of 1 square inch per CFM of supply (include free area undercut below door as part of the area).

Exceptions:

- Bathrooms, kitchens, closets, pantries, and laundry rooms.
- Rooms with louvered doors, or without doors, are exempt

Rationale:

- The lack of appropriate return air to a furnace diminishes the efficiency and effectiveness of a furnace.

Considerations:

- Future homeowners and future remodelers must be alerted that the doors have been undercut. Any remodeling where doors are replaced can affect the efficiency of the HVAC system.
- Consider marking the underside of the door indicating that there was an intentional undercut for ventilation efficiency.

Resources:

- TBD

5C-7_ Install fresh air intake (with or without damper) in home with no air intake

[Thank You Sponsors - Together We Improve Homes & People's Lives](#)

Requirements:

- Provide fresh air intake near gas furnace and gas water heater sized appropriately for the amount of fresh air required for equipment without depressurizing home. Fresh air intake must return upward in a “J” shape a minimum of 6” to prevent cold air from spilling into basement.
- Fresh air intake may or may not have damper



Exceptions:

- None

Rationale:

- This passive air intake is often called a “make-up” air supply. It helps prevent backdrafting by preventing depressurization and by allowing fresh air to enter the house when the house starts to undergo a negative pressure due to atmospherically venting appliances, the running of exhaust fans, or both.
- By preventing the possibility of serious depressurization in the house, make-up air systems also help reduce the chances of soil gases like radon from being pulled into the home.
- A properly wired electronically controlled damper can improve overall energy efficiency of the house by not allowing excessive air into the house when it is not needed, preventing backdrafting (e.g., damper closed when atmospherically venting appliances AND exhaust fans of 125 cfm or more are not running).

Considerations:

- It is recommended that this credit be combined with a Worst Case Combustion Spillage Test conducted by a Minnesota GreenStar approved rater or mechanical contractor. In some cases, even a fresh air intake may not keep atmospherically

[Thank You Sponsors - Together We Improve Homes & People's Lives](#)

appliances from backdrafting into home. Sometimes a larger air intake is required, and in some cases an active (motorized) make-up air is required.

Resources:

- TBD

5C-8_ Replace OLD passive combustion air intake with NEW intake and electronically controlled damper

Requirements:

- A new intake with an electronically controlled damper must be installed.

Exceptions:

- None

Rationale:

- A properly wired electronically controlled damper can improve overall energy efficiency of the house by not allowing excessive air into the house when it is not needed, preventing backdrafting (e.g., damper closed when atmospherically venting appliances AND exhaust fans of 125 cfm or more are not running)

Considerations:

- Verify that the duct and electronic damper are operating properly by having a mechanical contractor run diagnostics to verify the amount of airflow entering the home when the furnace is activated. Failure for the electronic damper to activate can draw air from non-fresh air sources and pose a health risk.

Resources:

- TBD

Resources:

- TBD

5C-9_ Insulate a minimum of 3' of piping exiting the boiler

Requirements:

- Use tubular style insulation (tape insulation also allowed), including elbows and turns
- All seams must be taped with a length of duct tape, no gaps.

Exceptions:

- Insulate using tubular style insulation to the wall if less than 3'

[Thank You Sponsors - Together We Improve Homes & People's Lives](#)

Rationale:

- Heat losses from the boiler can be as much as 35% of the energy for output of the boiler when pipes are un-insulated.
- Install insulation on supply lines, cutting notches in insulation at elbows for a tight fit.

Considerations:

- None

Resources:

- TBD

5C-10_ No radiator pipes located through an unconditioned space (e.g., unconditioned crawlspace, attic, or garage)

Requirements:

- Use tubular style insulation (tape insulation also allowed), including elbows and turns
- All seams must be taped with a length of duct tape, no gaps.

Exceptions:

- Insulate using tubular style insulation to the wall if less than 3'

Rationale:

- Heat losses from the boiler can be as much as 35% of the energy for output of the boiler when pipes are un-insulated.
- Install insulation on supply lines, cutting notches in insulation at elbows for a tight fit.

Considerations:

- None

Resources:

- TBD

5D- Heating and cooling equipment

5D-PR1_ No direct expansion systems allowed

Requirements:

- TBD
-

[Thank You Sponsors - Together We Improve Homes & People's Lives](#)

Exceptions:

- None

Rationale:

- Excessive uses of copper piping
- Concerns about long-term durability and ground water contamination.

Considerations:

- None

Resources:

- TBD

5D-PR2_ Drain pans connect to drainage system (not into slab)

Requirements:

- Drain pans shall be sloped, corrosion resistant (e.g., stainless or plastic) with drains at the low point. Condensate lines shall be drained to drainage system, not just deposited under slab.

Exceptions:

- None

Rationale:

- Almost all A/C equipment will have condensation emitting from them (as well as water heaters). Providing a reasonable way for the water to be moved away from the equipment eliminates corrosion possibilities, deterioration of the equipment, and keeps the possibility of stagnant water at bay.

Considerations:

- Draining equipment under the slab, or not providing a disaster pan at all, can both add moisture to the slab, floor, or be a potential flooding issue.

Resources:

- TBD

5D-1_ Design and install heating and cooling equipment according to ACCA Manual J calculations

Requirements:

- Provide ACCA Manual J calculations from by the HVAC contractor or Minnesota GreenStar rater with checklist.

[Thank You Sponsors - Together We Improve Homes & People's Lives](#)

Exceptions:

- None

Rationale:

- The ACCA Manual J appropriately sizes heating and cooling equipment based on a home's heating and cooling need, or load.
- The Manual J takes into account the following items.
- The local climate
- Size, shape, and orientation of the house
- Insulation levels
- Window area, location, and type
- Air infiltration rates
- The number and ages of occupants
- Occupant comfort preferences
- The types and efficiencies of lights and major home appliances (which give off heat). (www.eere.energy.gov)

Considerations:

- Most heating and cooling contractors do not size equipment properly, often oversizing equipment "to be safe". Instead, oversized equipment does not run efficiently, cost more money, and can over heat or cool a home.
- Oversized air conditioners may not cool a home properly because they do not sense the need to run long enough due to their size.

Resources:

- TBD

5D-2_ Heating and Cooling Equipment Efficiency. At the end of the project ALL heating and cooling equipment must meet or exceed one of the categories below to get credit.

Select one or two:

- 5D-2a_** Heating meets ENERGY STAR
(≥ 8.2 HSPF, ≥ 90 AFUE Furnace, ≥ 85 AFUE Boiler) (see manual for heat pump values)
 - 5D-2b_** Heating is better than ENERGY STAR
(≥ 8.6 HSPF, ≥ 92 AFUE Furnace, ≥ 87 AFUE Boiler) (see manual for heat pump values)
 - 5D-2c_** Substantially better than ENERGY STAR
(9.0 HSPF, ≥ 94 AFUE Furnace, ≥ 90 AFUE Boiler. See manual for heat pump values.)
 - 5D-2d_** Cooling meets ENERGY STAR
-

[Thank You Sponsors - Together We Improve Homes & People's Lives](#)

- 5D-2e_ (≥ 15 SEER,) (see manual for heat pump values_ Cooling is better than ENERGY STAR (≥ 16 SEER) (see manual for heat pump values)
- 5D-2f_ Cooling is substantially better than ENERGY STAR (≥ 17 SEER). See manual for heat pump values.)

Requirements:

- If an air source heat pump is installed, it shall have an outdoor thermostat installed according to manufacturer’s specifications that restricts electric resistance heating when outdoor air temperatures are above 40° F (EC, 21.3).
- All new heating and cooling equipment must be installed with a programmable thermostat equipped with “fan on” override capability.
- Heating and cooling systems must be designed using ACCA Manual J.
- All new heating and cooling equipment must have an efficiency rating as determined by the Air Conditioning and Refrigeration Institute (ARI), www.ari.org.
- Replacement of power vented mechanical equipment at 85% efficiency or greater for alternate systems must be reviewed by GreenStar administration to determine if credit will be awarded. There must be enough of an increase in performance to warrant changing out existing equipment.
- Use the following table to determine your efficiency category.

List of HVAC Credits	End-Use	Requirements for HVAC Equipment					
		Central AC & Air Source Heat Pumps	Furnaces	Boilers (Gas or Oil)	Open Loop	Geothermal Heat Pumps Closed Loop	Direct Expansion
ENERGY STAR	Cooling Heating	≥ 13 SEER ≥ 8.2 HSPF	≥ 90 AFUE	≥ 85 AFUE	≥ 16.2 EER ≥ 3.6 COP	≥ 14.1 EER ≥ 3.3 COP	≥ 15 EER ≥ 3.5 COP
Better than ENERGY STAR	Cooling Heating	≥ 14 SEER ≥ 8.6 HSPF	≥ 92 AFUE	≥ 87 AFUE	≥ 17.8 EER ≥ 4.0 COP	≥ 15.5 EER ≥ 3.6 COP	≥ 16.5 EER ≥ 3.9 COP
Substantially better than ENERGY STAR	Cooling Heating	≥ 15 SEER ≥ 9.0 HSPF	≥ 94 AFUE*	≥ 90 AFUE	≥ 19.4 EER ≥ 4.3 COP	≥ 17 EER ≥ 4.0 COP	≥ 18 EER ≥ 4.2 COP

Note: * designates furnace with low electric energy use

HVAC Efficiencies table adapted from LEED-H v1.11a.

Examples:

- If house has a 13 SEER central AC unit and a 92 AFUE furnace, choose 5D-2a.
- If house has one 90 AFUE boiler and one 92 AFUE furnace, choose 5D-2b.

Exceptions:

- None

Rationale:

[Thank You Sponsors - Together We Improve Homes & People’s Lives](#)



- The efficiencies of different heating and cooling equipment are not all described using the same unit system (e.g., SEER, AFUE, EER). Also, the overall efficiency of a system cannot be judged by the unit value alone. Hence the above table helps categorize the different systems in a more even way despite these differences.
- Note: The efficiency threshold for boilers is lower than it is for furnaces. This is due to the fact that boilers are a more efficient system for distributing heat.
- Existing boilers at 85% or better and furnaces at 89% or better are not worth replacing with new equipment due to the limited opportunity for increased performance and all of the embodied energy that it would take to replace it.

Considerations:

- None

Resources:

- TBD

5D-3_ Install ground source heat pump

Requirements:

- Notes on drawings and/or specifications indicating work to be done or product to use.
- Post-installation photo—OR—rater verification
- This credit may be taken in addition to the efficiency rating of the system

Exceptions:

- None

Rationale:

- Renewable source of heat and cool
- Very energy efficient

Considerations:

- Soil conditions must be right

Resources:

- TBD

5D-4_ Install multiple zones in home to improve energy efficiency

Requirements:

- A minimum of each level of the house is on a separate zone
- High and low use rooms are zoned separately

[Thank You Sponsors - Together We Improve Homes & People's Lives](#)

- Bedrooms are zoned separately from the rest of the home
- Additions and spaces built into the current home are zoned separately

Exceptions:

- Existing radiator systems can be expensive and difficult to re-zone. Direct-install on the unit dial style controls will be accepted with homeowner education on operation

Rationale:

- Being able to control the amount of heat in each room is an ideal way to control over heating some rooms, and under heating others. This strategy helps control heating costs, as less heat is needed to warm the home to desired temperatures.

Considerations:

- This strategy must be performed by a professional HVAC contractor who will help determine the right number of zones and right number of rooms to zone.

Resources:

- www.eere.energy.gov

5D-5_ Install hydronic in-floor heating system connected to heat source that has at least 80% AFUE boiler. Connecting to ground source heat pump or hot water solar systems also qualify.

Requirements:

- Hydronic in-floor heating system must be installed in a minimum of 200 sq. ft. or two rooms.
- It can be installed in conjunction with another heat source, such as forced air heat.

Exceptions:

- Less than 200 sq. ft. or two rooms can be installed if in conjunction with a hot water boiler heat system (radiators or baseboard) in the rest of the home.

Rationale:

- Hydronic, in-floor heat is a superior heating system to forced air for a number of reasons.
- The heat is radiant and at the floor level, close to the occupants, which typically results in greater comfort and less energy use since occupants are comfortable at a lower air temperature.
- It is much quieter than a forced air system.
- It requires much less space than a forced air system.

Considerations:

[Thank You Sponsors - Together We Improve Homes & People's Lives](#)

- It is not recommended that hydronic in-floor heat be installed under carpet or other surfaces, which require glues containing urea-formaldehyde. Hydronic in-floor heat is best suited under concrete or tile as a finished surface.
- Hardwood nailed into floors can be installed over hydronic in-floor heat when using a track system such as quick-trax, or structural track systems like warmboard. Care should be taken when selecting the wood species as the heat tends to shrink the wood in the winter, and woods that undergo bigger expansions and contraction rates may expose seams in the winter. Additionally, avoid mixing wood species that have different rates at expansion and contraction in the same installation pattern.
- A hydronic in-floor heat system should be installed in conjunction to a mechanical air distribution system, and to make sure adequate air intakes can provide fresh air to the home.

Resources:

- TBD

5D-6_ Furnace is equipped with an electronically commutated fan motor (ECMs) (variable speed motor)

Requirements:

- Documentation provided showing either the purchase or installation of variable speed motor

Exceptions:

- If the furnace is already equipped with a variable speed system, this credit will also count.

Rationale:

- ECM motors are more energy efficient than others.

Considerations:

- None

Resources:

- TBD

5D-7_ Air conditioner refrigerant is HCFC alternative

Requirements:

- Notes on drawings and/or specifications indicating work to be done or product to use.
- Post-installation photo—OR—rater verification

[Thank You Sponsors - Together We Improve Homes & People's Lives](#)

Exceptions:

- None

Rationale:

- Less degradation of the upper atmosphere

Considerations:

- None

Resources:

- TBD

5D-8_ Verify proper refrigerant charge by HVAC contractor

Requirements:

- Notes on drawings and/or specifications indicating work to be done or product to use.
- Post-installation photo—OR—rater verification

Exceptions:

- None

Rationale:

- Improved system performance

Considerations:

- None

Resources:

- TBD

5D-9_ House does not have A/C system and remodel designed to provide passive cooling (see 1B-12 for points)

Requirements:

- See 1B-12

Exceptions:

- None

Rationale:

[Thank You Sponsors - Together We Improve Homes & People's Lives](#)

- See 1B-12

Considerations:

- See 1B-12

Resources:

- See 1B-12

5D-10_ Measured airflow of new equipment within 10% of manufacturer's specifications

Requirements:

- Notes on drawings and/or specifications indicating work to be done or product to use.
- Airflow test results—OR—rater verification

Exceptions:

- None

Rationale:

- This shows that new equipment is running within a tolerable variance from manufacturer's specifications and is running efficiently.

Considerations:

- None

Resources:

- TBD

5D-11_ Establish interruptible service for air conditioner with electric service

Requirements:

- As stated above
- Submit documentation

Exceptions:

- None

Rationale:

- Allow electric utility to run more efficiently, which contributes to less global pollution.

Considerations:

[Thank You Sponsors - Together We Improve Homes & People's Lives](#)

- None

Resources:

- U.S. EPA www.epa.gov/cleanenergy/basic-information.html

5D-12_ Replace old steam boiler with a high efficiency hot water boiler

Requirements:

- Notes on drawings and/or specifications indicating work to be done or product to use.
- Airflow test results—OR—rater verification

Exceptions:

- None

Rationale:

- More energy efficient

Considerations:

- None

Resources:

- TBD

5D-13_ Install an aquastat control (for hot water boilers only)

Requirements:

- A modulating aquastat must be installed by a licensed professional

Exceptions:

- None

Rationale:

- A modulating aquastat, also called an outdoor reset, senses outdoor temperatures and adjusts the hot water temperature accordingly. The units can save up to 10% of fuel costs, and cost several hundred dollars.
- A cheaper alternative is to manually adjust the aquastat yourself, turning it down to around 120° F during the milder heating season. Consult your owner's manual or a service technician to locate the aquastat.

Considerations:

- None

[Thank You Sponsors - Together We Improve Homes & People's Lives](#)

Resources:

- www.eere.energy.gov/consumer/your_home/space_heating_cooling/index.cfm/mytopic=12550

5D-14_ Install a time-delay relay (for hot water boilers only)

Requirements:

- None

Exceptions:

- None

Rationale:

- A time delay relay is a way to squeeze the most heat out of your system without running the boiler. When the thermostat clicks on, the relay causes the boiler to circulate hot water through the system without turning on the boiler. After a set time, the boiler will fire up. A time delay relay costs about \$100 and can cut your fuel costs up to 10%.

Considerations:

- None

Resources:

- www.eere.energy.gov/consumer/your_home/space_heating_cooling/index.cfm/mytopic=12550

5E- Miscellaneous Mechanical

For fireplaces, or natural draft fuel-burning appliances to be acceptable in a new GreenStar home, they must be code compliant, vented to the outdoors, and have adequate combustion and ventilation air provided to minimize combustion spillage, backdrafting, and consumption of conditioned indoor air. Proper installation and integration with the air barrier of the home is also important. Manufacturer installation instructions should be referenced for these specifics on a product-by-product basis.

5E-PR1_ Site-built wood burning fireplaces must have gasketed doors, outside combustion air supply, and a means of sealing the flue to minimize interior air (heat) loss when not in operation

[Thank You Sponsors - Together We Improve Homes & People's Lives](#)

5E-PR2_ Factory-built wood burning fireplaces must meet certification requirements of UL 127 and be EPA certified (or meet requirements for sale under IPA's voluntary Clean-Burning Fireplace Program).

5E-PR3_ Wood stove and fireplace inserts must be EPA certified and meet certification requirements of US 1482, Section 3.8

5E-PR4_ Pellet (biomass/agrafuel) stoves and furnaces must meet the requirements of ASTM E1509 or be EPA certified

5E-PR5_ Masonry heaters must meet the definition of ASTM e1602 and the IBC 2112.1

5E-1_ No decorative fireplace or stove of any kind exists at the end of the project (applies to wood, gas, electric and biomass, etc.)

Requirements:

- As stated above.

Exceptions:

- None

Rationale:

- While decorative fireplaces and stoves can contribute a lot to the aesthetics and charm of a home, they typically worsen the overall environmental footprint of it. Therefore credit is given to homes that have found design solutions that do NOT include them.
- Typically, at best, decorative fireplaces and stoves are an accessory heat source and do not provide heat as efficiently as the primary heating system in the house. At worst, they can be a significant source of heat loss, both during use and when not in use.
- Stone or brick chimney stacks can fail over time due to bulk water, moisture, nests, or leaves. If other mechanicals use the same chimney for ventilation, the same failures can plague the mechanicals as well, causing them to backdraft carbon monoxide.

Considerations:

[Thank You Sponsors - Together We Improve Homes & People's Lives](#)

- None

Resources:

- TBD

5E-2_ Install a central vacuum system that is vented to the exterior

Requirements:

- This type of vacuum system does not blow dust and impurities into the air inside the house like most other vacuums.

Exceptions:

- None

Rationale:

- Central vacuum systems use low-voltage electricity and provide more cleaning flexibility. Some systems even have ports, which allow sweeping dirt and dust in high traffic areas directly into the vacuum system.

Considerations:

- Traditional central vacuum systems are installed using PVC, a dangerous and harmful plastic. Make sure the system is installed using plastic piping other than PVC, such as HPBE, ABS, or similar.
- Make sure piping is well sealed. If the pipes are not sealed with adhesive, there is a potential for dust and other contaminants to exit the system and enter the wall cavities.
- The canister, which collects the vacuumed particles must be changed on a regular basis.
- Ensure make-up air requirements are met.

Resources:

- TBD

[Thank You Sponsors - Together We Improve Homes & People's Lives](#)

6 ELECTRICAL

Electricity is created from several main energy sources including coal, hydropower, nuclear power, and natural gas. Our country has become reliable on this convenient form of energy. Yet, the production of electricity has been wrought with environmental challenges such as nuclear waste disposal, habitat destruction, mercury poisoning, acid rain, and elevated carbon dioxide emissions implicated in global warming. While we cannot rid ourselves of dependence on electricity, we can begin changing the way we use electricity to reduce need and the environmental destruction caused by our current methods of production. Many conservation methods are listed below to assist in the design and construction of more energy efficient remodeling projects. Another option for creating a cleaner future is to invest in ways to create electricity that are less harmful to the environment. At the top of the list is the creation of electricity from sun and wind energy. In Minnesota over 63% of our energy comes from coal, which is not only highly inefficient with 70% of the energy lost in transmission, but it also is the most environmentally damaging.

6PR -Prerequisites

6PR-1_ New appliances must meet or exceed ENERGY STAR requirements

Requirements:

- Provide a receipt of purchase.
- Present copy of energy label from appliance. Keep original label on appliance or in homeowner's manual

Exceptions:

- None

Rationale:

- ENERGY STAR is a program developed by the Environmental Protection Agency to recognize appliances that use 10-50% less energy and water than standard models.

Considerations:

- None

Resources:

- ENERGY STAR.gov/index.cfm?c=appliances.pr_appliances

[Thank You Sponsors - Together We Improve Homes & People's Lives](#)

6PR-2_ If recessed light fixtures are being added where they penetrate into the unconditioned area of the attic, then fixtures must be installed to prevent air and thermal leakage (see 3PR-7 & 4PR-7)

Requirements:

- Rater will verify installation
- See 3PR-7 4PR-7 for recommended strategy to seal fixtures to reduce the risk of air leakage

Exceptions:

- None

Rationale:

- Anytime a penetration is made into the building envelope, there is a risk that airflow from conditioned space to unconditioned space can occur. Since water vapor flows with air, there is an increased risk to the durability of the structure.
- It is always wisest to minimize penetrations into the building envelope. See 6B-16 and 6B-17 for points awarded for not installing any recessed light fixtures in the home or at least not in the insulated ceilings.

Considerations:

- None

Resources:

- TBD

6PR-3_ Adhere to the National Electric Code (NEC) during installation of wiring

Requirements:

- Any code violations discovered during the course of the remodel must be amended, especially where the occupants' health may be placed at risk. This includes the crossing of neutral conductors in junction boxes from two or more circuits that may cause parallel return paths for current. Similarly, neutral to ground connections in branch circuitry, per NEC, should be avoided and all conductors for three-way switches shall be sourced from the same circuit. A traveler wire may be required between switches to avoid uncovered prior wiring errors.

Exceptions:

- None

Rationale:

[Thank You Sponsors - Together We Improve Homes & People's Lives](#)

- Most cities and towns inspect electrical installations as part of a permit process. This prerequisite is intended to remind occupants and installers of the importance of adhering to proper electrical wiring practice if, for some reason, the project is not inspected

Considerations:

- None

Resources:

- www.nfpa.org/freecodes/free_access_document.asp

6A- Appliances

Appliances are large consumers of energy, especially those that are in continuous operation like refrigerators, freezers, room air conditioners, and ice makers. Choosing energy efficient appliances helps reduce need for energy production and reduces homeowner cost of operation over time.

6A-1_ Document energy consumption and age of all existing major appliances

Requirements:

- Use the website below and the model numbers of your appliances to find energy consumption information on existing appliances.

Exceptions:

- None

Rationale:

- When you know how much energy your appliances are using compared to today's efficiency standards you will be able to make informed decisions about whether to replace the appliances with more energy efficient models.

Considerations:

- None

Resources:

- TBD

6A-2_ Replace existing appliances older than 1993 (ENERGY STAR rated required)

[Thank You Sponsors - Together We Improve Homes & People's Lives](#)

Select All That Apply:

- 6A-2a_ Refrigerator
- 6A-2b_ Room air conditioner
- 6A-2c_ Dishwasher
- 6A-2d_ Clothes washer

Requirements:

- Must do 6A - 1 if taking Credit 6A - 2.
- List the replacement appliance, its model number, and year made
- Provide receipt from new appliance of ENERGY STAR label

Exceptions:

- None

Rationale:

- Appliances produced after 1993 have gone through significant design changes that have allowed for improvements in energy efficiency ratings and cost savings during operation.

Considerations:

- None

Resources:

- TBD

6A-3_ Install Super Efficient Home Appliances - CEE Tier 1

Select All That Apply:

- 6A-3a_ Refrigerator
- 6A-3b_ Room air conditioner
- 6A-3c_ Dishwasher
- 6A-3d_ clothes washer

Requirements:

- List the new appliance, its model number, efficiency information, and year made.
- Provide receipt
- Refrigerators must be a minimum of 20% more efficient than federal standard
- Dishwashers must have maximum annual energy usage ≤ 339 kWh/year and Energy Factor (EF) ≥ 0.65
- Clothes Washers must have Modified Energy Factor (MEF) ≥ 1.8 and Water Factor (WF) ≤ 7.5

[Thank You Sponsors - Together We Improve Homes & People's Lives](#)

- Room air conditioners:
 - < 8,000 Btu/h = 11.2 EER
 - 8,000-13,999 Btu/h = 11.3 EER
 - 14,000-19,999 Btu/h = 11.2 EER
 - >/= 20,000 Btu/h = 9.8 EER
- Some credits may not apply if the home is fully converted to photovoltaic or wind power systems. Credits not available can be applied for in the innovation section.

Exceptions:

- None

Rationale:

- Super Efficient Home Appliances (SEHA) is a national program to promote energy and water efficient appliances by the Consortium for Energy Efficiency. The program is a complement to ENERGY STAR and seeks to encourage the use of the super efficient appliances when possible. The program provides specifications for super efficient refrigerators, room air conditioners, dishwashers, and clothes washers, but not other types of appliances.
- Although all SEHA products are efficient, the tiers are structured so that the more efficient products are located in the higher tiers. Tier 3 contains the most efficient models.

Considerations:

- None

Resources:

- www.cee1.com
- www.cee1.org/resid/seha/dishw/dw-prod.pdf for a list of qualifying dishwashers
- www.cee1.org/resid/seha/rwsh/rwsh-prod.pdf for a list of qualifying clothes washers
- www.cee1.org/resid/seha/rm-ac/rm-ac_specs.pdf qualifying information for room air conditioners (see www.energystar.gov website for manufacturer information)
- www.cee1.org/resid/seha/refrig/refrig-spec.pdf qualifying information for refrigerators (see www.energystar.gov website for manufacturer information)

6A-4_ Install Super Efficient Home Appliances - CEE Tier 2

Select All That Apply:

- 6A-4a_ Refrigerator
- 6A-4b_ Room air conditioner
- 6A-4c_ Dishwasher
- 6A-4d_ Clothes washer

[Thank You Sponsors - Together We Improve Homes & People's Lives](#)

Requirements:

- List the new appliance, its model number, efficiency information, and year made
- Provide receipt
- Refrigerators must be a minimum of 25% more efficient than federal standard
- Dishwashers must have maximum annual energy usage ≤ 325 kWh/year and Energy Factor (EF) ≥ 0.68
- Clothes Washers must have Modified Energy Factor (MEF) ≥ 2.0 and Water Factor (WF) ≤ 6.0
- Room air conditioners:
 - < 8,000 Btu/h = 11.6 EER
 - 8,000-13,999 Btu/h = 11.8 EER
 - 14,000-19,999 Btu/h = 11.6 EER
 - $\geq 20,000$ Btu/h = 10.2 EER
- Some credits may not apply if the home is fully converted to photovoltaic or wind power systems. Credits not available can be applied for in the innovation section.

Exceptions:

- None

Rationale:

- Super Efficient Home Appliances (SEHA) is a national program to promote energy and water efficient appliances by the Consortium for Energy Efficiency. The program is a complement to ENERGY STAR and seeks to encourage the use of the super efficient appliances when possible. The program provides specifications for super efficient refrigerators, room air conditioners, dishwashers, and clothes washers, but not other types of appliances.
- Although all SEHA products are efficient, the tiers are structured so that the more efficient products are located in the higher tiers. Tier 3 contains the most efficient models.

Considerations:

- None

Resources:

- www.cee1.com
- www.cee1.org/resid/seha/dishw/dw-prod.pdf for a list of qualifying dishwashers
- www.cee1.org/resid/seha/rwsh/rwsh-prod.pdf for a list of qualifying clothes washers
- www.cee1.org/resid/seha/rm-ac/rm-ac_specs.pdf qualifying information for room air conditioners (see www.energystar.gov website for manufacturer information)
- www.cee1.org/resid/seha/refrig/refrig-spec.pdf qualifying information for refrigerators (see www.energystar.gov website for manufacturer information)

6A-5_ Install Super Efficient Home Appliances - CEE Tier 3

[Thank You Sponsors - Together We Improve Homes & People's Lives](#)

Select All That Apply:

- 6A-5a_ Refrigerator
6A-5b_ Clothes washer

Requirements:

- List the new appliance, its model number, year made, and efficiency information.
- Provide receipt
- Refrigerators must be a minimum of 30% more efficient than federal standard
- Clothes Washers must have Modified Energy Factor (MEF) ≥ 2.2 and Water Factor (WF) ≤ 4.5
- Some credits may not apply if the home is fully converted to photovoltaic or wind power systems. Credits not available can be applied for in the innovation section.

Exceptions:

- None

Rationale:

- Super Efficient Home Appliances (SEHA) is a national program to promote energy and water efficient appliances by the Consortium for Energy Efficiency. The program is a complement to ENERGY STAR and seeks to encourage the use of the super efficient appliances when possible. The program provides specifications for super efficient refrigerators, room air conditioners, dishwashers, and clothes washers, but not other types of appliances.
- Although all SEHA products are efficient, the tiers are structured so that the more efficient products are located in the higher tiers. Tier 3 contains the most efficient models.

Considerations:

- None

Resources:

- www.cee1.com
- www.cee1.org/resid/seha/rwsh/rwsh-prod.pdf for a list of qualifying clothes washers
- www.cee1.org/resid/seha/refrig/refrig-spec.pdf qualifying information for refrigerators (see www.energystar.gov website for manufacturer information)

6A-6_ Install an outdoor clothesline

Requirements:

[Thank You Sponsors - Together We Improve Homes & People's Lives](#)

- Document clothesline installation with a photograph

Exceptions:

- None

Rationale:

- Clotheslines are an example of a Green strategy that is not a new concept or technology. They work efficiently through the use of sun and wind energy to dry.

Considerations:

- Make sure all clotheslines are installed outside. Drying on an indoor clothesline can lead to excess moisture in the home and compromise durability.

Resources:

- TBD

6A-7_ Install or replace electric cook top with gas cook top

Requirements:

- List the name of the appliance and its model number
- Provide receipt

Exceptions:

- If your home is off the grid and your energy source comes from solar power, it makes sense to use electric appliances.

Rationale:

- Gas is a cleaner fuel than electricity provided by the grid, which is largely sourced from coal power plants.

Considerations:

- The tradeoff for using gas fuel over electric is the introduction of moisture and combustion products into the home. It is critical for good indoor air quality to provide venting to the outside.

Resources:

- TBD

6A-8_ Install induction cook top

Requirements:

[Thank You Sponsors - Together We Improve Homes & People's Lives](#)

- List the name of the appliance and its model number
- Provide receipt

Exceptions:

- None

Rationale:

- An induction cook top is powered by a small amount of electricity that produces a magnetic field. When the magnetic field is activated in the presence of certain metal pots and pans, the energy created is transferred into the cookware. This energy is converted into heat that is transferred to the food for cooking. Heat is only produced in the cookware reacting to the magnet but not the induction surface, so the cook top stays cool.
- In order for an induction cook top to work, the cookware must be steel or cast iron (a magnet must stick to it)
- With an induction cook top there is significantly less wasted energy than an electric cook top, while avoiding the indoor environmental concerns associated with natural gas.

Considerations:

- None

Resources:

- TBD

6A-9_ Install or replace electric dryer with gas dryer

Requirements:

- List the name of the appliance and its model number
- Provide receipt

Exceptions:

- If your home is off the grid and your energy source comes from solar power, it makes sense to use electric appliances.

Rationale:

- Gas is a cleaner fuel than the electricity provided by the grid, which is largely sourced from coal power plants.

Considerations:

- None

[Thank You Sponsors - Together We Improve Homes & People's Lives](#)

Resources:

- TBD

6A-10_ Number of energy consuming electrical appliances is five (5)

Requirements:

- Energy consuming appliances for these credits are related to the kitchen and laundry. Do not include home heating and cooling appliances.
- This credit refers to electric appliances. DO NOT count gas appliances in total.
- An electric range counts as two appliances (cook top and oven). A double oven and a microwave oven combination unit also count as two appliances.
- Typical appliances are the refrigerator, cook top, oven or range, dishwasher, microwave, clothes washer, and clothes dryer. The easiest way to qualify for this credit is to install a gas cook top and dryer, and to not install additional appliances.
- List all appliances in the home and note whether they are gas or electric.

Exceptions:

- None

Rationale:

- The purpose of this credit is to limit the number of energy consuming appliances and to reduce the use of unnecessary second and third refrigerators, warming drawers, ice makers, wine chillers, etc.
- Even products that are not in use, or “turned off,” are using energy in stand-by mode or to power a clock or microcomputer. This “phantom load” can be a significant source of wasted energy.

Considerations:

- None

Resources:

- TBD

6A-11_ Number of energy consuming electrical appliances is four (4) or less

Requirements:

- Energy consuming appliances for these credits are related to the kitchen and laundry. Do not include home heating and cooling appliances.
- This credit refers to electric appliances. DO NOT count gas appliances in total.
- An electric range counts as two appliances (cook top and oven). A double oven and a microwave oven combination unit also count as two appliances.

[Thank You Sponsors - Together We Improve Homes & People's Lives](#)

- Typical appliances are the refrigerator, cook top, oven or range, dishwasher, microwave, clothes washer, and clothes dryer. The easiest way to qualify for this credit is to install a gas cook top and dryer, and to not install additional appliances.
- List all appliances in the home and note whether they are gas or electric.

Exceptions:

- None

Rationale:

- The purpose of this credit is to limit the number of energy consuming appliances and to reduce the use of unnecessary second and third refrigerators, warming drawers, ice makers, wine chillers, etc.
- Even products that are not in use, or “turned off,” are using energy in stand-by mode or to power a clock, remote or microcomputer. This “phantom load” or “ghosting” can be a significant source of wasted energy.

Considerations:

- None

Resources:

- TBD

6A-12_ Provide switched outlets to dedicated media centers and home offices

Requirements:

- To save energy, a switch for the circuit of media components and office equipment should be installed to eliminate the unnecessary use of electricity.
- Use power strips on all electronics with the exception of systems that would cause phone service loss if turned off.
- Although it doesn’t qualify for this credit, it may be possible to disable clocks on electronic devices. Consult the owner’s manual or manufacturer’s website.

Exceptions:

- None

Rational:

- Even products that are not in use, or “turned off,” are using energy in stand-by mode or to power a clock, remote or microcomputer. This “phantom load” or “ghosting” can be a significant source of wasted energy

Considerations:

- None

[Thank You Sponsors - Together We Improve Homes & People’s Lives](#)

Resources:

- aceee.org/consumerguide/electronics.htm

6A-13_ Install whole house surge protection

Requirements:

- List the type of surge protector and manufacturer information such as model number

Exceptions

- None

Rationale:

- A whole house surge protection system should be installed to avoid the unnecessary damage to sensitive electrical equipment from external sources.
- The whole house system surge protector is a first line of defense against electrical spikes, surges, and other disturbances, particular due to lightning.
- Sensitive electronics, like media components and computer equipment, should be protected by point-specific surge protectors.

Considerations:

- Convenience devices like TIVO and automatic timers are disabled when power to the room is off.

Resources:

- TBD

6B-Fans, fixtures and lights

The electric load of a house can be lowered, by choosing hardwired and plug-in fixtures that are designed to operate more efficiently and use less energy.

6B-1_ Home has some or all ENERGY STAR Advanced Lighting Package features

Requirements:

- Provide a schedule of all lighting used, indicate ENERGY STAR fixtures, and calculate percentage of ENERGY STAR fixtures compared to total fixtures per room category.

Exceptions:

- None
-

[Thank You Sponsors - Together We Improve Homes & People's Lives](#)

Rationale:

- ENERGY STAR Advanced Lighting Package is a prescriptive program that helps reduce energy through the use of energy efficient technologies
- ENERGY STAR qualified lighting uses about 75% less energy and produces 75% less heat than standard models.

Considerations:

- None

Resources:

- www.energystar.gov/index.cfm?c=fixtures.alp_consumers

6B-1a_ Fixtures in high-use rooms (kitchen, dining room, living room, family bathroom, hall stairway) are qualified by ENERGY STAR (xx% of fixtures)

6B-1ai_	50%
6B-1aii_	90%

6B-1b_ Fixtures in medium/low-use rooms (bedroom, office, basement, laundry room, garage, closet) are qualified by ENERGY STAR (xx% of fixtures)

6B- 1bi_	50%
6B-1bii_	90%

6B-1c_ Outdoor lighting fixtures, including flood lighting, are qualified by ENERGY STAR (xx% of fixtures)

6B-1ci_	50%
6B-1cii_	90%

6B-2_ Install halogen in 30% of the remodeled space. Halogen fixtures make up 30% of fixtures where CFL or LED fixtures are not used.

Requirements:

- Provide a schedule of all lighting used; indicate halogen fixtures, and calculate percentage of halogen bulbs compared to total bulbs.

Exceptions:

[Thank You Sponsors - Together We Improve Homes & People's Lives](#)

- None

Rationale:

- Halogen lights are about 10-20% more efficient than incandescent bulbs.
- Halogen lights produce a brighter light than incandescent bulbs as well as have a longer life. The use of premium fill gases, like xenon, further increases their efficiency.

Considerations:

- Halogen lights produce an excessive amount of heat. Care should be taken when specifying halogen lights to consider the implications of the added heat to the room.
- Care should be taken to not directly touch halogen bulbs because it can reduce the life of the bulb.
- Halogen lights are hot to the touch and care should be taken to prevent the fixture from coming into contact with flammable materials.

Resources:

- None

6B-3_ Install CFL bulbs in 50% of whole house

Requirements:

- Provide a schedule of all lighting used, indicate CFL, and calculate percentage of CFL bulbs compared to total bulbs.

Exceptions

- None

Rationale:

- “If every American home replaced just one light bulb with an ENERGY STAR qualified bulb, we would save enough energy to light more than 3 million homes for a year, more than \$600 million in annual energy costs, and prevent greenhouse gases equivalent to the emissions of more than 800,000 cars.” - ENERGY STAR
- Compact fluorescent light (CFL) bulbs use 2/3 the energy, last up to 10 times longer, and generate 70% of the heat of incandescent bulbs. CFLs can typically be used in place of incandescent bulbs.
- Considerations:
- Be sure to use a CFL rated for dimming when connected to a dimmer switch
- When using compact fluorescent light bulbs outdoors be sure to get bulbs with cold weather ballasts.
- Due to small amounts of mercury in compact fluorescent light bulbs they should be recycled properly at the end of their useful life.

[Thank You Sponsors - Together We Improve Homes & People's Lives](#)

Resources:

- www.energystar.gov/index.cfm?c=cfls.pr_cfls

6B-4_ Install CFL bulbs in 90% of whole house

Requirements:

- Provide a schedule of all lighting used, indicate CFL, and calculate percentage of CFL bulbs compared to total bulbs.

Exceptions:

- None

Rationale:

- “If every American home replaced just one light bulb with an ENERGY STAR qualified bulb, we would save enough energy to light more than 3 million homes for a year, more than \$600 million in annual energy costs, and prevent greenhouse gases equivalent to the emissions of more than 800,000 cars.” - ENERGY STAR
- Compact fluorescent light (CFL) bulbs use 2/3 the energy, last up to 10 times longer, and generate 70% of the heat of incandescent bulbs. CFLs can typically be used in place of incandescent bulbs.

Considerations:

- Be sure to use a CFL rated for dimming when connected to a dimmer switch.
- When using compact fluorescent light bulbs outdoors be sure to get bulbs with cold weather ballasts.
- Due to small amounts of mercury in compact fluorescent light bulbs they should be recycled properly at the end of their useful life.

Resources:

- www.energystar.gov/index.cfm?c=cfls.pr_cfls

6B-5_ Install CFL bulbs in all recessed can light fixtures

Requirements:

- Provide an electrical plan that indicates all can light fixtures
- Use compact fluorescent light (CFL) bulbs with reflectors to direct light downward

Exceptions:

Rationale:

[Thank You Sponsors - Together We Improve Homes & People's Lives](#)

- Compact fluorescent light (CFL) bulbs use 2/3 the energy, last up to 10 times longer, and generate 70% of the heat of incandescent bulbs. CFLs can typically be used in place of incandescent bulbs.

Considerations:

- Be sure to use a CFL rated for dimming when connected to a dimmer switch.
- When using compact fluorescent light bulbs outdoors be sure to get bulbs with cold weather ballasts.
- Due to small amounts of mercury in compact fluorescent light bulbs they should be recycled properly at the end of their useful life.

Resources:

- www.energystar.gov/index.cfm?c=cfls.pr_cfls

6B-6_ Install LED bulbs in all recessed can light fixtures

Requirements:

- Provide an electrical plan that indicates all can light fixtures
- Any can light fixtures that penetrate the building envelope must be insulated according to ??-?? To prevent air leakage into unconditioned space.
- Rater verification

Exceptions:

- None

Rationale:

- LED, or light emitting diode fixtures use significantly less electricity than incandescent lighting without the need for mercury ballast like a CFL. LED lighting products last longer than CFL, with some bulbs lasting 60,000 hours.

Considerations:

- None

Resources:

- TBD

6B-7_ Install three (3) LED light fixtures

Requirements:

- Provide a schedule of all lighting used, indicate LED fixtures, and calculate percentage of LED compared to total fixtures.

[Thank You Sponsors - Together We Improve Homes & People's Lives](#)

Exceptions:

- None

Rationale:

- LED, or light emitting diode fixtures use significantly less electricity than incandescent lighting without the need for mercury ballast like a CFL. LED lighting products last longer than CFL, with some bulbs lasting 60,000 hours.

Considerations:

- LED lighting is more directional than incandescent lighting and works well for task lighting.

Resources:

- TBD

6B-8_ Install six (6) LED light fixtures

Requirements:

- Provide a schedule of all lighting used and indicate LED fixtures.

Exceptions:

- None

Rationale:

- LED, or light emitting diode fixtures use significantly less electricity than incandescent lighting without the need for mercury ballast like a CFL. LED lighting products last longer than CFL, with some bulbs lasting 60,000 hours.

Considerations:

- LED lighting is more directional than incandescent lighting and works well for task lighting.

Resources:

- None

6B-9_ Install LED light fixtures in 50% of high use rooms

Requirements:

- Provide a schedule of all lighting used, indicate LED fixtures, and calculate percentage of LED bulbs compared to total bulbs.

[Thank You Sponsors - Together We Improve Homes & People's Lives](#)

Exceptions:

- Rope lights are counted as 1 bulb for every 3' of length.

Rationale:

- LED, or light emitting diode fixtures use significantly less electricity than incandescent lighting without the need for mercury ballast like a CFL. LED lighting products last longer than CFL, with some bulbs lasting 60,000 hours.

Considerations:

- LED lighting is more directional than incandescent lighting and works well for task lighting.

Resources:

- TBD

6B-10_ Install LED light fixtures in 90% of high use rooms

Requirements:

- Provide a schedule of all lighting used, indicate LED fixtures, and calculate percentage of LED bulbs compared to total bulbs.

Exceptions:

- Rope lights are counted as 1 bulb for every 3' of length.

Rationale:

- LED, or light emitting diode fixtures use significantly less electricity than incandescent lighting without the need for mercury ballast like a CFL. LED lighting products last longer than CFL, with some bulbs lasting 60,000 hours.

Considerations:

- LED lighting is more directional than incandescent lighting and works well for task lighting.

Resources:

- None

6B-11_ Limit total indoor lighting energy usage to less than 0.5 watts per square foot

Requirements:

[Thank You Sponsors - Together We Improve Homes & People's Lives](#)

- Calculation of total watts per square foot is based on the rated wattage of each fixture, not the bulb that is used to light the fixture
- Square foot calculation requires inclusion of all light fixtures, both permanent and removable

Exceptions:

- None

Rationale:

- It is possible to achieve a variety of lighting goals (e.g., task, general, focused) with a minimal amount of wattage per square foot when you combine CFL, halogen, and LED.
- LED and Halogen provide light that is more directed which makes them good choices for task lighting.
- CFL lighting is more diffused making it work well for ambient, or general, lighting

Considerations:

- None

Resources:

- TBD

6B-12_ Install dimmers on all lights in high use rooms where compact fluorescent lights are not installed

Requirements:

- Provide an electrical plan that indicates dimmer switches.
- High use rooms include the kitchen, dining room, living room, family room, bathroom(s), hall(s), and stairway(s)

Exceptions

- None

Rationale:

- Dimmers provide variable control over lighting level and reduce energy use by reducing the wattage. Dimmers are available in magnetic and electronic varieties for different types of fixtures and should be installed in accordance with the fixture specifications.
- Two different types of dimmers exist—those controlled by the occupant and those that sense the quantity of available light and adjust accordingly.
- Fluorescent light fixtures require special ballasts.

[Thank You Sponsors - Together We Improve Homes & People's Lives](#)

Considerations:

- Make sure to turn have a switch in the “off” position before installing a dimmable CFL.
- Dimmable CFL bulbs require full power to light. Turn on light at full power and then dim to required amount of light.

Resources:

- www.energyfederation.org/consumer/default.php/cPath/2050_25_44_169

6B-13_ Install dimmers on all lights in medium/low use rooms where compact fluorescent lights are not installed

Requirements:

- Provide an electrical plan that indicates dimmer switches.
- Medium/low use rooms include bedroom(s), den, office, basement, laundry room, garage, closet(s), and all other rooms.

Exceptions

- None

Rationale:

- High use rooms include the kitchen, dining room, living room, family room, bathroom(s), hall(s), and stairway(s). Dimmers provide variable control over lighting level and reduce energy use by reducing the wattage. Dimmers are available in magnetic and electronic varieties for different types of fixtures and should be installed in accordance with the fixture specifications.
- Two different types of dimmers exist—those controlled by the occupant and those that sense the quantity of available light and adjust accordingly.
- Fluorescent light fixtures require special ballasts.

Considerations:

- Make sure to turn have a switch in the “off” position before installing a dimmable CFL.
- Dimmable CFL bulbs require full power to light. Turn on light at full power and then dim to required amount of light.

Resources:

- www.energyfederation.org/consumer/default.php/cPath/2050_25_44_169

6B-14_ Install automatic indoor lighting controls in all high use rooms

[Thank You Sponsors - Together We Improve Homes & People's Lives](#)

Requirements:

- High use rooms include the kitchen, dining room, living room, family room, bathroom(s), hall(s), and stairway(s).
- Automatic indoor lighting controls include timers and occupant sensors.
- Provide detailed lighting plan

Exceptions:

- None

Rationale:

- These controls reduce unnecessary energy use from light fixtures being left on.
- Timers are also used on indoor lights to provide the appearance that people are home, but do not require that the lights be permanently left on.
- Occupant-sensors ensure that lights are only when people are in the room.

Considerations

- None

Resources:

- TBD

6B-15_ Install automatic indoor lighting controls in all medium/low use rooms

Requirements:

- Medium/low use rooms include bedroom(s), den, office, basement, laundry room, garage, closet(s), and all other rooms
- Automatic indoor lighting controls include timers and occupant sensors.
- Provide detailed lighting plan

Exceptions:

- None

Rationale:

- These controls reduce unnecessary energy use from light fixtures being left on.
- Timers are also used on indoor lights to provide the appearance that people are home, but do not require that the lights be permanently left on.
- Occupant-sensors ensure that lights are only when people are in the room.

Considerations:

- An additional option for closets is to use jamb switches that turn the light on when the door is opened and off when the door is closed. Jamb switches would not be

[Thank You Sponsors - Together We Improve Homes & People's Lives](#)

recommended for walk in closet where the door could be closed while someone is inside the closet or the door may be frequently left open.

Resources:

- TBD

6B-16_ No recessed light fixtures installed in any part of the house

Requirements:

- Provide detailed electrical plan and photos.
- Rater verification

Exceptions:

- None

Rationale:

- Recessed light fixtures create opportunities for airflow to pass between conditioned space and unconditioned space as well as into the building envelope between floors. Since air can carry moisture, it is not wise to create opportunities that introduce air/moisture to the building envelope. Trapped moisture can increase the potential for damage to the structure.
- There are many ways to add light to a space that don't require recessed fixtures. Look for cable lighting, track and bendable track lighting, as well as ceiling lights and wall sconces.
- Can lights are inefficient at providing light for a room requiring a significantly larger watt per square foot load.

Considerations:

- Be sure that any electrical penetrations to the building envelope are sealed to prevent airflow.

Resources:

- None

6B-17_ No recessed light fixtures added in insulated ceilings

Requirements:

- Provide detailed electrical plan and photos.

Exceptions:

[Thank You Sponsors - Together We Improve Homes & People's Lives](#)

- Recessed light fixtures installed in insulation used for sound control between floors are acceptable as long as they are properly rated for contact with insulation.
- The third-party verifier will need to inspect installation.

Rationale:

- Recessed light fixtures installed in insulation that is part of the thermal barrier are not advised because they penetrate the building envelope, are difficult to seal and insulate properly frequently causing air and moisture transfer between conditioned and unconditioned spaces, reducing the efficiency of the building and increasing the potential for damage to the structure.
- Can lights are inefficient at providing light for a room requiring a significantly larger watt per square foot load.

Considerations:

- None

Resources:

- TBD

6B-18_ Existing recessed light fixtures that penetrate the building envelope in all locations removed and none added (minimum 80% light fixtures)

Requirements:

- When removing recessed light fixtures that penetrate the building envelope it is critical that the air and moisture barriers be repaired, and insulation is maintained.
- Provide detailed electrical plan.

Exceptions:

- None

Rationale:

- Recessed light fixtures installed in insulation that is part of the thermal barrier are not advised because they penetrate the building envelope and frequently cause air and moisture transfer between conditioned and unconditioned spaces, reducing the efficiency of the building and increasing the potential for damage to the structure.

Considerations:

- None

Resources:

- See 2M-20 for further explanation of recessed light fixtures in insulated ceilings.

[Thank You Sponsors - Together We Improve Homes & People's Lives](#)

6B-19_ Install new ENERGY STAR fans or replace old ceiling fans with ENERGY STAR fans

Select one:

- 6B-19a_ 1 room
- 6B-19b_ 2 rooms
- 6B-19c_ 3 rooms
- 6B-19d_ 4 rooms
- 6B-19e_ 5 or more rooms

Requirements:

- Each fan should be installed in the center of the room
- Exceptions:
- Existing fans do not need to be relocated if not in the center of the room

Rationale:

- Non-ENERGY STAR-rated fans typically use a lot of electricity relative to how much air they move. Replacing them with ENERGY STAR-rated fans will save energy, and have a net cost savings and a net benefit to the environment in the long run.
- Ceiling fans help people feel more comfortable through evaporative cooling.
- They are also important for drawing warm air from the ceiling to the lower areas of a room during cold months and removing warm air from the lower portion of a room during warm months

Considerations:

- None

Resources:

- www.energystar.gov/index.cfm?c=ceiling_fans.pr_ceiling_fans

6B-20_ Solar powered walkway or outdoor lighting (minimum 6 fixtures)

Requirements:

- Provide detailed outdoor lighting plan

Exceptions

- None

Rationale

- Solar powered fixtures convert sunlight into electricity and store it in batteries for use at night. The solar unit can be integrated into the unit or a separately located panel.

[Thank You Sponsors - Together We Improve Homes & People's Lives](#)

Considerations:

- Consideration should be given to locating the solar units in areas where they will receive sunlight.

Resources:

- TBD

6B-21_ Install automatic outdoor lighting controls or photocells/timers

Requirements:

- Provide detailed outdoor lighting plan
- Automatic outdoor lighting controls include motion sensors and photocells/timers

Exceptions

- None

Rationale:

- The use of lighting controls reduces energy consumption by making sure lights are not left on while they are not needed during the daylight hours.

Considerations:

- None

Resources:

- TBD

6B-22_ Reduce light pollution by shielding fixtures and/or directing light downward

Requirements:

- Provide detailed outdoor lighting plan

Exceptions:

- None

Rationale:

- Unshielded exterior fixtures contribute to light pollution by illuminating upward and outward, in addition to the area that needs to be lit.
- The negative impacts of light pollution include glare (which can obstruct vision), lighting of neighboring properties, and contributing to urban/suburban sky brightness.

[Thank You Sponsors - Together We Improve Homes & People's Lives](#)

- In addition to the negative impacts, the upward and outward light emitted wastes energy.

Considerations:

- None

Resources:

- www.darksky.org

6B-23_ Limit outdoor lighting to total maximum of 100 watts

Requirements:

- Parking area lighting shall be high-pressure sodium or equivalent high efficiency.
- A lighting schedule showing total wattage used is required along with general contractor sign-off on checklist.
- Lighting is rated by the maximum wattage listed on the fixture, not by the bulbs that are used.

Exceptions:

- None

Rationale:

- While outdoor lighting can be important for safety, it can also contribute to light pollution. The negative impacts of light pollution include glare (which can obstruct vision), lighting of neighboring properties, and contributing to urban/suburban sky brightness.

Considerations:

- None

Resources:

- TBD

6C- WIRING

6C-1_ Remove all knob and tube wiring from home

Requirements:

- By code, knob and tube wiring must be removed in the areas impacted by remodeling when more than 60% is exposed as a result of the remodel. Removing the knob and

[Thank You Sponsors - Together We Improve Homes & People's Lives](#)

tube wiring in the remodeled areas only does not qualify for this credit. To qualify, the remaining knob and tube wiring must also be removed from the home.

- Removing all of the knob and tube wiring during a whole house remodel will qualify, even though the work is required by code.
- Knob and tube wiring that is disconnected and abandoned also qualifies.

Exceptions:

- None

Rationale:

- Knob and tube wiring should be replaced and/or abandoned wherever found because it poses risk for fire and safety as well as significant magnetic and electric field exposure.
- Knob and tube wiring is significantly less safe than modern wiring.

Considerations:

- None

Resources:

- TBD

6C-2_ Direct wire all bath fans to light switch or humidistat (See 5A - 4 for points)

- [See 5A - 4](#)

6C-3_ Ceiling fan pre-wires provided in habitable rooms (minimum 2 pre-wires, not including bathrooms)

Requirements:

- Provide detailed electrical plan.

Exceptions:

- None

Rationale:

- Providing for future addition of a ceiling fan will prevent unnecessary remodeling when a ceiling fan is needed.
- Ceiling fans help people feel more comfortable through evaporative cooling.
- They are also important for pushing warm air from the ceiling to the lower areas of a room during cold months and removing warm air from the lower portion of a room during warm months.

[Thank You Sponsors - Together We Improve Homes & People's Lives](#)

Considerations:

- None

Resources:

- www.energystar.gov/index.cfm?c=ceiling_fans.pr_ceiling_fans

6D- Electrical Systems

6D-1_ Homeowner signs up for 100% wind power from local electric utility (if available)

Requirements:

- Contact local utility to find out how to sign up for wind power.
- Provide receipt of commitment from the power company to show the amount of wind power purchased per month.

Exceptions:

- None

Rationale:

- When a homeowner signs up for wind power it means they are contributing to the research, development and installation of wind power, a clean form of electricity. It does not mean that 100% of the energy going to the home is from wind. Their monthly contribution is important to creating more wind-based electricity in the state.
- Check with the local utility to determine the cost of investing in wind power research and development. Often times wind power is purchased in 100 kWh increments.

Considerations:

- None

Resources:

- None

6D-2_ Photovoltaic ready home. Install wiring conduit for future PV installation and provide a minimum 200 sq. ft. within 15 degrees of south, with a roof angle of 30-50 degrees

Requirements:

- Provide detailed electrical plan.
 - Describe proposed photovoltaic system and electric generation goals.
-

[Thank You Sponsors - Together We Improve Homes & People's Lives](#)

- Cap conduit at each end and Label “Solar Ready” at each end.

Exceptions

- None

Rationale:

- Providing for the future addition of a photovoltaic (PV) system will prevent unnecessary remodeling when a PV system is installed.

Considerations

- None

Resources:

- TBD

6D-3_ Solar electric photovoltaic system installed

Select one:

- 6D-2a_ One kilowatt
6D-2b_ Two kilowatts or greater

Requirements:

- Provide detailed system plan and expected energy generation goals including site assessment
- Use licensed electrician who has experience with photovoltaic (PV) installations.

Exceptions:

- None

Rationale:

- Solar electricity requires an upfront commitment to a higher equipment cost—creating electricity through PV is an investment.
- Once the equipment costs are paid off, the energy from the sun will be free over the life of the system.
- A PV system will not have the same issues associated with fossil fuel based power—rising costs and limited supply

Considerations:

- Because of the high cost associated with PV, it is important to have an assessment of the solar access and hours of sunlight before to determine if PV is the right choice.

[Thank You Sponsors - Together We Improve Homes & People's Lives](#)

- There are many energy upgrades that can be done for the same cost as PV. It would be wise to investigate the options to create a tighter building envelope and reduced energy loads before investing in PV

Resources:

- www.ases.org
- www1.eere.energy.gov/consumer/tips/renewable_energy.html

6D-4_ No electric in-floor heating

Requirements:

- Provide detailed electric plan.

Exceptions:

- None

Rationale:

- Electric in-floor heating systems are not efficient systems for heating a room compared to other systems.
- While a heated floor offers comfort, electric in-floor systems generally have a much shorter lifespan than the floor systems they heat. This often requires immature replacement of the floor in order to replace the heated floor system.

Considerations:

- If the room to be remodeled is known for being cold, an energy audit using a Blower Door Test and infrared scan may help to identify areas for air sealing and insulation that could improve comfort without the need for supplemental heat. See 2Pr-1 and 2C-3 for further explanation of these two helpful tests.
- If you do install an electrical heating system you can improve the energy usage by setting the cables in 1-3” of tile base (sand and mortar mix).
- Extra care should be taken in basement applications, as heat from the cables will conduct heat through the entire concrete slab further reducing efficiency. Installation of a thermal break is critical.

Resources:

- None

6D-5_ For electrical and magnetic fields see [Section 11B](#)

6D-6_ On-site wind turbine system installed

[Thank You Sponsors - Together We Improve Homes & People's Lives](#)

Select one:

- 6D-6a_ Five kilowatts to nine kilowatts
6D-6b_ Ten kilowatts or greater

Requirements:

- Provide detailed system plan and expected energy generation goals including site assessment
- Use licensed electrician who has experience with wind turbine system installations.

Exceptions:

- None

Rationale:

- Conversion of wind into a power source creates minimal negative environmental effects compared to other sources of power.
- Once the equipment costs are paid off, the energy from the wind will be free over the life of the system.
- A wind system will not have the same issues associated with fossil fuel based power—rising costs and limited supply

Considerations:

- Because of the high cost associated with wind systems, it is important to have an assessment of the amount of wind and predictability at the site to determine if it is the right choice.
- There are many energy upgrades that can be done for the same cost as wind energy. It would be wise to investigate the options to create a tighter building envelope and reduced energy loads before investing in wind.

Resources:

- TBD

7 Water - Plumbing, Systems & Fixtures

Water is a critical compound for the health of all living systems. While the earth's surface is over 70% water, 97% of that water is salt water. Of the remaining 3% almost 70% is locked up in glaciers, leaving a very small amount available as accessible potentially potable water via groundwater and lakes and streams.

In Minnesota, the land of 10,000 lakes, over 43% of our lakes and waterways are designated as impaired by the MPCA (Minnesota Pollution Control Agency). We have also experienced

[Thank You Sponsors - Together We Improve Homes & People's Lives](#)

significant water shortages over the last decade, resulting in the sharp drop in many of our largest lakes, and restrictions on irrigation as aquifers reach critical levels.

The human body can store energy as fat and use it to sustain itself during stressful situations. Yet, humans cannot store water in quantities sufficient to sustain life for more than a few days. While water falls freely from the sky, our practices of diverting it into storm sewers and away from our houses and buildings is failing to replenish the aquifers we rely on for fresh drinking water and irrigation. Water that moves into streams and rivers is lost to the greater drainage systems around the world that end with the mixing of fresh water with salt water in the oceans. Rather than capture that water on site to use for our irrigation needs, or allow it to be filtered by the soil and return to the aquifers, we pay our city and state to manage and process the water so it is safe to drink, or send into the river. We then turn around and purchase drinkable water to water our lawns and gardens.

Water scarcity will have far reaching impacts. Before having enough water to sustain human life is an issue, the cost of food production will be. Agriculture is heavily dependant on large quantities of water, and as aquifers are depleted water will be imported or piped in from other areas. We already have a number of examples from around the world that illustrate how the tensions over access to water will overshadow any concerns about energy that we might have today.

The growth in energy demand and world population has also put a demand on water as a source for power generation. Dams across the world hold water in reservoirs for power use. Water also plays a crucial role in the production of energy as it is used to keep nuclear plants cool, and keep coal plants operational.

Many of the strategies for water conservation are adapted from time-tested practices such as the use of rain barrels and cisterns to capture and reuse water on-site. Storm water management strategies guide a homeowner in practices that keep water out of the foundation while allowing it to remain on the property to soak into the soil and replenish aquifers. Simple tests to locate plumbing leaks eliminate water loss.

Simple technologies, like aerators, reduce the amount of water that flows from faucets and shower heads. More advanced technologies like dual-flush toilets and front-loading washing machines allow for significant water savings than past technologies. By incorporating a few of these strategies into your next project each household could save hundreds of thousands of gallons per year.

Conservation and water management are key to a future of fresh and plentiful water. The following credits are helpful measures that promote water conservation and water reuse.

7A- Equipment

[Thank You Sponsors - Together We Improve Homes & People's Lives](#)

7PR-1_ All newly installed plumbing fixtures and appliances meet or exceed the 2005 National Energy Policy Act standards for water usage.

Requirements:

- Provide receipts and manufacturer's specifications

Exceptions:

- None

Rationale:

- The NEPA was enacted in 2005 as a means to educate the public on energy and water issues, and to enforce conservation measures on a national level.
- Required by law.

Considerations:

- None

Resources:

- <http://www.epa.gov/watersense/docs/matrix508.pdf>
- National Energy Policy Act of 2005 - http://frwebgate.access.gpo.gov/cgi-bin/getdoc.cgi?dbname=109_cong_public_laws&docid=f:publ058.109.pdf

7A-1_ Replace or install new water heater

Select all that apply:

- 7A-1a_ Install a sealed combustion unit
- 7A-1b_ Install tankless water heater (electric)
- 7A-1c_ Install tankless water heater (gas)
- 7A-1d_ Install a high efficiency 88% min tankless water heater
- 7A-1e_ Install a heat trap or demand valve on water heater
- 7A-1f_ Install a hot water demand re-circulation pump for homes with hot water runs of greater than 100'
- 7A-1g_ Install a Drain water Heat Recover (DHR) unit
- 7A-1h_ Install power vented water heater

Requirements:

- A water heater with a tank is to be installed so that overflow or leaks are captured by drains. (EC, 39.10)
- Tank type water heaters will be ENERGY STAR certified

[Thank You Sponsors - Together We Improve Homes & People's Lives](#)

- Provide receipt of product purchase, model number, or ENERGY STAR label for tank type.

Exceptions:

- Homes that install an alternate energy source are encouraged to use appliances that consume electricity and can take the same points as a natural gas unit (see 7A-1b)

Rationale:

- Sealed combustion water heaters with direct venting ensure that the carbon monoxide, a byproduct of the combustion process used to heat the water, is vented out of the home and not drawn back in. Sealed combustion and direct venting is particularly important with tightly built (energy efficient) homes because the carbon monoxide could easily reach unsafe levels.
- A tankless water heater heats water only when there is a demand. It eliminates the loss of energy through heat loss while the water is stored in a tank. A tankless water heater/demand system can have 45-60% energy savings over the minimum standard water heater. It is important to correctly size the tankless water heater for the house to ensure it can generate sufficient hot water to meet demand, even when there are multiple simultaneous uses (e.g., running the washer and shower simultaneously). Tankless water heaters are also available for point of use applications, like hot water at the kitchen sink. The point of use tankless water heaters do not count for this credit, unless they fully replace a standard storage tank water heater, but can increase homeowner satisfaction and reduce wasted water by shortening the time between turning the water on and receiving hot water.
- The water heater's efficiency is measured as an energy factor (EF), which is shown on the label of the heater. The higher number indicates a more energy efficient unit.
- A heat trap can either be a loop in the plumbing or a special valve that prevents convection. New storage tank water heaters may have heat trap valves already installed. Heat traps stop the outflow of hot water from the water heater.
- A recirculation pump pulls hot water from the heater and sends the cooled water back to the water heater to be reheated. The recirculation pump can be activated by either thermostat, timer, or manually. The thermostat and timer help ensure that hot water is always available quickly. The manual switch requires less energy because the pump is not activated when hot water is not needed. On longer plumbing runs the recirculation pump greatly reduces the amount of water used before the hot water reaches the point-of-use, reducing the water wasted while waiting for it to warm up.
- A Drain Water Heat Recovery (DHR) unit captures the heat from wastewater leaving the home and transfers it into the cold water entering the water heater. By boosting the temperature of the cold water entering the water heater, the water heater doesn't have to use as much energy to heat the water in the tank.
- A power vented water heater, while relying on room air for combustion, has an exhaust system that is vented out the side of the house rather than a chimney.

[Thank You Sponsors - Together We Improve Homes & People's Lives](#)

- Electricity in Minnesota is dirty power with 63% produced through burning coal and a 70% loss in transmission. The efficiency of the unit is negated by the impact of the energy source on the environment.

Considerations:

- None

Resources:

- www.state.mn.us/mn/externalDocs/Commerce/Water_Heaters_110802042613_Water_Heaters.pdf
- www.eere.energy.gov/consumer/your_home/water_heating/index.cfm/mytopic=13040

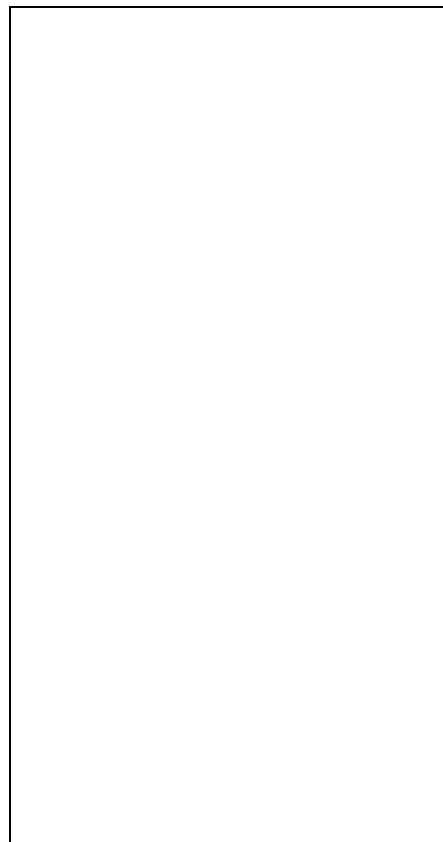

(EC, 45)

7A-2_ Install water heater timer on any tank water heater

[Thank You Sponsors - Together We Improve Homes & People's Lives](#)

Requirements:

- Provide receipt for purchase and installation or photo.

Exceptions:

- None

Rationale:

- Water heater timer saves energy by turning off the water heater at night, when demand for hot water is low. Having the utility company install a control device that turns off an electric water heater during peak demand periods will also qualify for this credit. Typically the utility does not shut off the water heater long enough for the occupants to experience a loss in hot water.

Considerations:

- None

Resources:

- TBD

7B-Fixtures

7B-1_ Install NSF certified water filters on all drinking water sources

Requirements:

- To qualify, a point-of-use system must be plumbed in through the main faucet or a separate auxiliary faucet next to the main faucet. Pour through, faucet mounted, and countertop filter systems do not qualify.
- A receipt will be required for documentation.

Exceptions:

- None

Rationale:

- The National Sanitation Foundation verifies the claims of manufacturers and ensures products conform to strict standards (www.nsf.org). The NSF certification provides third-party assurance that the product reduces the contaminants as claimed by the manufacturer. In order to earn certification for reduction of a contaminant the tested product must be able to reduce a specific amount that contaminant. Even with certification it is important that proper maintenance and filter changing are performed to ensure continued performance.

[Thank You Sponsors - Together We Improve Homes & People's Lives](#)

Considerations:

- None

Resources:

- www.nsf.org/consumer/drinking_water/dw_treatment.asp?program=WaterTre#technologies

7B-2_ Install NSF certified whole house water filter

Requirements:

- Provide a receipt of purchase and installation.

Exceptions:

- None

Rationale:

- The National Sanitation Foundation verifies the claims of manufacturers and ensures products conform to strict standards (www.nsf.org). The NSF certification provides third party assurance that the product reduces the contaminants as claimed by the manufacturer. In order to earn certification for reduction of a contaminant the tested product must be able to reduce a specific amount that contaminant. Even with certification it is important that proper maintenance and filter changing are performed to ensure continued performance.
- A point of entry, or whole house, system is installed where the water enters the house, typically at the meter. All of the water used in the house is filtered making point-of-use filters unnecessary.
- An adsorption system, typical carbon filter, reverse osmosis system (explained further in 6AS-4), ultraviolet disinfecting system, or distiller system qualifies for this credit.

Considerations:

- Pour through, faucet mounted, and countertop filter system do not qualify.
- If a reverse osmosis system is used (see 7A-6), a loss of a point in the water conservation category will occur due to the water wasted by using this system.

Resources:

- www.nsf.org/consumer/drinking_water/dw_treatment.asp?program=WaterTre#technologies

7B-3_ Install an NSF certified reverse osmosis filter on all drinking water sources

[Thank You Sponsors - Together We Improve Homes & People's Lives](#)

Requirements:

- Provide a receipt of purchase and installation.
- This credit cannot be taken with 7B-2.

Exceptions:

- None

Rationale:

- Reverse osmosis systems remove contaminant in water by using high pressure to force the water through a semi-permeable membrane that filters the water. A reverse osmosis system can filter out smaller particles than other types of filtering systems

Considerations:

- The downside of the reverse osmosis filtering process is that large amounts of water are wasted. For every gallon of filtered water approximately 4-10 gallons are wasted.

Resources:

- TBD

7B-4_ Install chlorine filters on showerheads or whole house chlorine filter

Requirements:

- Provide receipt and manufacturer's specifications

Exceptions:

- None

Rationale:

- Chlorine is used to eliminate microorganism from the water supply to reduce waterborne illnesses. However, chlorine may have adverse health effects ranging from cancer, asthma, and heart disease, to dry skin and hair.

Considerations:

- None

Resources:

- TBD

7B-5_ Limit showerheads to one per shower

[Thank You Sponsors - Together We Improve Homes & People's Lives](#)

Requirements:

- Provide a photograph of each bathtub and shower as proof that only one showerhead has been installed.

Exceptions:

- None

Rationale:

- Each showerhead that is added increases the loss of water as well as energy needed to heat the water.

Considerations:

- None

Resources:

- None

7B-6_ Replace/install showerheads with low-flow (maximum 2.5 gpm) showerheads

Requirements:

- This credit requires that 75% of the showerheads meet the requirement.
- Provide receipt and manufacturer's specifications

Exceptions:

- None

Rationale:

- The Energy Policy Act (EPAct) of 1992 mandated stricter water conservation strategies, however, there are many older homes that have not been renovated and are wasting water with flow rates for showerheads that exceed the stricter standards. Replacing these showerheads is a way to make an impact on water conservation.

Considerations:

- None

Resources:

- None

7B-7_ Replace/install showerheads with very low-flow (maximum 2.0 gpm)

Requirements:

[Thank You Sponsors - Together We Improve Homes & People's Lives](#)

- This credit requires that 75% of the showerheads meet the requirement.
- Provide receipt and manufacturer's specifications for each fixture

Exceptions:

- None

Rationale:

- As the flow rate decreases, so does the amount of water loss. Decreasing flow rate from 2.5 gpm to 2.0 gpm saves 20% on water usage.

Considerations:

- It is important to that note insulating pipes and locating the hot water heater to deliver hot water more efficiently to all spaces is important as the flow rate decreases. If these items are not addressed, the occupant may be waiting a long time for hot water to reach the faucet.
- If long plumbing runs are an issue, see 5A-2f about re-circulating pump.

Resources:

- None

7B-8_ Replace/install showerheads with ultra low-flow (maximum 1.0 gpm)

Requirements:

- This credit requires that 75% of the showerheads meet the requirement.
- Provide receipt and manufacturer's specifications for each fixture

Exceptions:

- None

Rationale:

- As the flow rate decreases, so does the amount of water loss. Decreasing flow rate from 2.5 gpm to 1.0 gpm saves 70% on water usage.

Considerations:

- It is important to note that insulating pipes and locating the hot water heater to deliver hot water more efficiently to all spaces is important as the flow rate decreases. If these items are not addressed, the occupant may be waiting a long time for hot water to reach the faucet.
- If long plumbing runs are an issue, see 7A-1f about re-circulating pump.

Resources:

- TBD

[Thank You Sponsors - Together We Improve Homes & People's Lives](#)

7B-9_ Replace all showerheads in home with low-flow (2.5 gpm)

Requirements:

- Provide receipt and manufacturer's specifications for each fixture
- Homeowner or general contractor can verify that these measures have been installed.

Exceptions:

- None

Rationale:

- Replacing all the showerheads will result in a significant reduction in water usage.

Considerations:

- None

Resources:

- TBD

7B-10_ Seal around tub and shower traps in basement or other "slab set" drain locations using a plastic box as a form

Requirements:

- Plumbing penetrations shall be blocked with sheeting and sealed at edges with proper sealant. Rockwool or similar product does not qualify.
- Run the roughed-in plumbing in a plastic box that is cast into the slab. Remove the top of the box, leaving the rest in place. Seal around the pipes as they pass through the box perimeter.
- A photograph of each trap is required.

Exceptions:

- None

Rationale:

- None

Considerations:

- Penetrations in the slab provide potential Radon release into the home.

[Thank You Sponsors - Together We Improve Homes & People's Lives](#)

- Drains that leak into the slab may not be visible until considerable saturation of the slab has occurred creating potentially changing Conditions due to high moisture content.

Resources:

- TBD

7B-11_ Install new, very low-flow, dual-flush toilet (0.8/1.6 gpf), or pressure assist (1.1 gpf) toilet

Requirements:

- 66% of toilets in home must meet this criteria
- Provide receipt and manufacturer's specifications

Exceptions:

- None

Rationale:

- Dual-flush toilets have two buttons. One button is used for flushing liquid waste using less water. The other button is used for flushing solid waste with a larger quantity of water. It is the average of the two types of flushing that brings the total water used over the course of a day below the EAct requirements for low-flow fixtures.

Considerations:

- None

Resources:

- www.epa.gov/watersense/

7B-12_ Install new toilets with 1.2 gpf

Requirements:

- Provide receipt and manufacturer's specifications

Exceptions:

- None

Rationale:

- Current toilets are required to be 1.6 gpf. There are options on the market to reduce the quantity of water needed to flush solid and liquid waste.

[Thank You Sponsors - Together We Improve Homes & People's Lives](#)

Considerations:

- None

Resources:

- TBD

7B-13_ Replace all toilets in home with low-flow (1.6 gpf)

Requirements:

- This credit requires that all toilets be replaced with a low-flow model
- Provide receipt and manufacturer's specifications

Exceptions:

- None

Rationale:

- Many existing toilets flush waste using 4 to 5 gallons of water. Replacing just one toilet is a good step in water conservation. Replacing more than one toilet obviously contributes to greater water savings.
- Replacing a toilet can save a family of four almost 20,000 gallons per year.

Considerations:

- None

Resources:

- www.epa.gov/watersense/

7B-14_ Replace all toilets with very low-flow, dual-flush toilet (0.8/1.6 gpf), or pressure assist (1.1 gpf) toilet

Requirements:

- This credit requires that all toilets be replaced with a very low-flow model
- Provide receipt and manufacturer's specifications

Exceptions:

- None

Rationale:

- Dual-flush toilets have two buttons. One button is used for flushing liquid waste using less water. The other button is used for flushing solid waste with a larger quantity of

[Thank You Sponsors - Together We Improve Homes & People's Lives](#)

water. It is the average of the two types of flushing that brings the total water used over the course of a day below the EPA's requirements for low-flow fixtures.

Considerations:

- None

Resources:

- www.epa.gov/watersense/

7B-15_ Replace all toilets with 1.3 gpf

Requirements:

- Provide receipt and manufacturer's specifications

Exceptions:

- None

Rationale:

- Current toilets are required to be 1.6 gpf. There are options on the market to reduce the quantity of water needed to flush solid and liquid waste.

Considerations:

- None

Resources:

- None

7B-16_ Install composting toilet

Requirements:

- Confirm with local code officials that a composting toilet can be installed.
- Provide receipt and manufacturer's specifications

Exceptions:

- None

Rationale:

- A composting toilet provides a container for the decomposition of the waste by biological organisms that breakdown waste into usable compost. By using a composting toilet human waste does not enter the sewer system.

[Thank You Sponsors - Together We Improve Homes & People's Lives](#)

Considerations:

- None

Resources:

- www.buildinggreen.com/auth/productsByCsiSection.cfm?SubBuilderCategoryID=6941

7B-17_ Replace all faucets or add aerators with low-flow (maximum 2.2 gpf)

Requirements:

- Provide receipt and manufacturer's specifications

Exceptions:

- None

Rationale:

- As the public gains a greater awareness for the need for water conservation, plumbing manufacturers have begun to provide products to meet the demand. If you are not able to locate a faucet with the desired flow rating, an aerator can be installed on most fixtures to reduce flow. Look for aerators at a plumbing distributor or hardware store.

Considerations:

- None

Resources:

- www.epa.gov/watersense/pp/bathroom_faucets.htm

7B-18_ Replace all faucets or add aerators with very low-flow (1.5 gpf)

Requirements:

- Provide receipt and manufacturer's specifications

Exceptions:

- None

Rationale:

- As the public gains a greater awareness for the need for water conservation, plumbing manufacturers have begun to provide products to meet the demand. If you are not able to locate a faucet with the desired flow rating, an aerator can be installed on most fixtures to reduce flow. Look for aerators at a plumbing distributor or hardware store.

Considerations:

[Thank You Sponsors - Together We Improve Homes & People's Lives](#)

- None

Resources:

- www.epa.gov/watersense/pp/bathroom_faucets.htm

7B-19_ Replace all faucets or add aerators with ultra low-flow (1.0 gpf)

Requirements:

- Provide receipt and manufacturer's specifications

Exceptions:

- None

Rationale:

- As the public gains a greater awareness for the need for water conservation, plumbing manufacturers have begun to provide products to meet the demand. If you are not able to locate a faucet with the desired flow rating, an aerator can be installed on most fixtures to reduce flow. Look for aerators at a plumbing distributor or hardware store.

Considerations:

- None

Resources:

- www.epa.gov/watersense/pp/bathroom_faucets.htm

7B-20_ Replace all faucets or add aerators with ultra low-flow (.5 gpf)

Requirements:

- Provide receipt and manufacturer's specifications

Exceptions:

- None

Rationale:

- As the public gains a greater awareness for the need for water conservation, plumbing manufacturers have begun to provide products to meet the demand. If you are not able to locate a faucet with the desired flow rating, an aerator can be installed on most fixtures to reduce flow. Look for aerators at a plumbing distributor or hardware store.

[Thank You Sponsors - Together We Improve Homes & People's Lives](#)

Considerations:

- None

Resources:

- www.epa.gov/watersense/pp/bathroom_faucets.htm

7B-21_ Shut-off valve, motion sensor, or pedal activated faucet to enable intermittent on/off operation (kitchen or lavatory)

Requirements:

- Provide receipt and manufacturer's specifications

Exceptions:

- None

Rationale:

- As the public gains a greater awareness for the need for water conservation, plumbing manufacturers have begun to provide products to meet the demand. It is convenient when cleaning in a kitchen or brushing teeth in a bathroom to keep the water running, but the practice is wasteful. Products exist that are helpful for the user while promoting water conservation.
- Combining low-flow faucets with motion sensors will make it difficult to get warm water from the fixture unless it is on a recirculation loop.

Considerations:

- Motion sensors that are wired or require a battery must deduct one energy point from their total. Motion sensors that have a self charging battery are exempt.

Resources:

- www.epa.gov/watersense/pp/bathroom_faucets.htm

7C-Piping

7C-1_ Use copper alternative (PEX) when adding new or replacing existing water supply pipes

Requirements:

- Provide receipt and manufacturer specifications.
 - Provide photo at pre-drywall
-

[Thank You Sponsors - Together We Improve Homes & People's Lives](#)

Exceptions:

- None

Rationale:

- PEX is cross-linked polyethylene flexible tubing that is resistant to extreme temperatures and well suited for interior hot and cold plumbing lines. Because it is flexible it can reduce the number of connections required, which reduces the chances of leaks and reduces installation labor. It is scale resistant, chlorine resistant, and does not develop pinhole leaks, which are drawbacks of copper.
- Copper is a semi-precious metal that produces significant environmental degradation and uses large amounts of water and energy during mining and processing.

Considerations:

Resources:

- www.buildinggreen.com/auth/productsByCsiSection.cfm?SubBuilderCategoryID=3300
- www.ppfahome.org/pex/faqpex.html

7C-2_ Replace galvanized water lines

Requirements:

- Provide photographs of existing water pipes to be removed --AND-- newly installed water pipes

Exceptions:

- None

Rationale:

- As a galvanized water line ages, minerals in water begin to build up in the line. This build up does not affect water quality, but affects the ability of the pipe to deliver water efficiently, and possibly lead to a clog.
- Galvanized lines were common in the building industry 100 years ago.
- As galvanized pipes age they begin to rot, raising the possibility of leaks which can impact the durability of the home.

Considerations:

- None

Resources:

- TBD

[Thank You Sponsors - Together We Improve Homes & People's Lives](#)

7C-3_ Install circulation loop within 10' of each fixture (except utility sink)

Requirements:

- A photograph of the installed loop will be required for documentation.

Exceptions:

- None

Rationale:

- This recirculation pump will minimize wait time for hot water, thereby reducing waste. Remote switches to activate the system shall be installed on intermediate fixtures between the pump and water heater.

Considerations:

- None

Resources:

- TBD

7C-4_ Install water heater jacket on hot water heater (minimum R-8)

Requirements:

- A photograph of the installation will be required for documentation as well as a description of the water jacket and its insulation value.

Exceptions:

- None

Rationale:

- A hot water heater needs a jacket if the exterior of the tank is warm to the touch. A water heater jacket will reduce the stand-by heat loss of the water in the storage tank and help save money.
- Check with your utility company to see if they offer rebates or sell them for reduced cost.

Considerations:

- None

Resources:

- www.eere.energy.gov/consumer/your_home/water_heating/index.cfm/mytopic=13070

[Thank You Sponsors - Together We Improve Homes & People's Lives](#)

7C-5_ Install water heater pipe insulation for first 20' of pipe

Requirements:

- Provide receipt and manufacturer's specifications

Exceptions:

- None

Rationale:

- Insulating hot water pipes will reduce the heat loss of the water in the lines and the wait time for hot water, which will reduce the amount of water wasted while waiting for hot water.
- Because the pipes are able to maintain a higher temperature it may also be possible to lower the temperature settings of the water heater, further reducing energy use.

Considerations:

- None

Resources:

- eere.energy.gov/consumer/your_home/water_heating/index.cfm/mytopic=13060

7C-6_ Centralize water heater, place as equidistant from fixtures as possible

Requirements:

- Indicate the plumbing runs on construction plans and show length of water runs.

Exceptions:

- None

Rationale:

- A central location will minimize the overall amount of piping. The central location will reduce the overall wait times for hot water, which will reduce the amount of water wasted while waiting for hot water.
- This is both an energy and water saving technique

Considerations:

- None

Resources:

- TBD

[Thank You Sponsors - Together We Improve Homes & People's Lives](#)

7C-7_ Install central manifold for distribution with minimum R-4 on all hot water lines

Requirements:

- A manifold distribution system is to be installed so that each plumbing fixture in the house has a dedicated water line back to the manifold.
- Provide photographs to show connection of fixtures to manifold

Exceptions:

- None

Rationale:

- This design approach minimizes the diameter of the water pipes and reduces the amount of water wasted while waiting for hot water to reach the fixture. (EC, 45.9)

Considerations:

- None

Resources:

- TBD

7C-8_ Perform a water leak test and remediate leaks discovered

Requirements:

- Provide a written description of where the leaks were found and what was done to correct the problem.

Exceptions:

- None

Rationale:

- Leaks, even when small, are a large source of wasted water over time. It is estimated that leaks account for 1/10 of household water consumption.
- Leaks can cause substantial damage to the house and can provide the conditions for mold growth.

Considerations:

- None

Resources:

- www.savingwater.org/docs/leaks.pdf

[Thank You Sponsors - Together We Improve Homes & People's Lives](#)

7C-9_ Install whole house fire suppression system

Requirements:

- Provide product specifications and receipt for system
- Provide photo at completion

Exceptions:

- None

Rationale:

- Not only does a fire suppression system reduce the damage caused by a fire and resultant property losses, it helps to save lives and reduce injury.
- The installation of a fire suppression system may result in reduced insurance rates.

Considerations:

- None

Resources:

- www.usfa.dhs.gov/citizens/all_citizens/home_fire_prev/sprinklers/

7D-Water Systems

7D-1_ Install a graywater collection system that annually captures and reuses a minimum of 50% of home's graywater

Requirements:

- Provide receipt and manufacturer's specifications

Exceptions:

- None

Rationale:

- Graywater is all wastewater not contaminated by human/toilet waste or food waste from garbage disposals. It includes water draining from showers, sinks, and clothes washers. After being filtered the graywater is used for landscape irrigation or flushing the toilet.

Considerations:

[Thank You Sponsors - Together We Improve Homes & People's Lives](#)

- Review local plumbing codes and discuss with code officials before designing the system.
- Wastewater from toilets and garbage disposals is called blackwater and must be treated separately from graywater. Blackwater contains higher levels of nitrogen, pathogens, and other contaminants, and takes longer to decompose, than graywater. However, blackwater can also be handled without entering the sewer or septic system. Item 7B-16 provides credit for installing a composting toilet to handle toilet waste and 7D-7 discourages the installation of garbage disposals.
- Limiting water use for landscape irrigation may be a more practical alternative to a graywater system and may result in a similar number of points (see Section 2 - Outdoor and Site)

Resources:

- None

7D-2_ Install solar domestic water heating system (minimum 50% of water heating load)

Requirements:

- Integrate solar water heating system needs into design of project
- Provide receipt for system

Exceptions:

- None

Rationale

- Solar water heating systems use collector plates typically mounted on the roof to preheat water. The preheated water is either stored in its own tank before it enters a conventional water heater or the storage tank and water heater are combined in one unit. Due to freezing temperatures in Minnesota an indirect circulation system should be used where a non-freezing liquid is circulated through the collector plates and then through a heat exchanger that transfers the energy to the water.

Considerations:

- None

Resources:

- www.eere.energy.gov/consumer/your_home/water_heating/index.cfm/mytopic=12850

7D-3_ Install heat-pump system that is combined with water heating system

[Thank You Sponsors - Together We Improve Homes & People's Lives](#)

Requirements:

- None

Exceptions:

- The homeowner or general contractor can verify on-site that this measure is installed.

Rationale:

- A heat pump water heater system removes heat from the environment and transfers it into the water. The heat can come from the room (ambient), exhaust, or outdoor air. In climates like Minnesota it is more typical to use an exhaust system. In addition, a super-heater can be installed with the air conditioner to capture the heat generated while cooling the house as the source for the heat pump.

Considerations:

- None

Resources:

- None

7D-4_ Provide south roof area for future domestic solar hot water heating system (minimum 30 sq. ft. within 15 degrees of south with a roof angle of 30-50 degrees) and plumbing rough-in for solar water heating system

Requirements:

- The homeowner or general contractor can verify on-site if plumbing rough-ins are installed.

Exceptions:

- None

Rationale:

- Solar water heating systems use collector plates typically mounted on the roof to preheat water. The preheated water is either stored in its own tank before it enters a conventional water heater, or the storage tank and water heater are combined in one unit plates and then through a heat exchanger that transfers the energy to the water.
- The preheated water is either stored in its own tank before it enters a conventional water heater, or the storage tank and water heater are combined in one unit. Due to freezing temperatures in Minnesota an indirect circulation system should be used where a non-freezing liquid is circulated through the collector plates and then through a heat exchanger that transfers the energy to the water.

[Thank You Sponsors - Together We Improve Homes & People's Lives](#)

- Even if you are not installing the system now, planning for future possible installation will prevent the need for extensive remodeling in the future.

Considerations:

- None

Resources:

- TBD

7D-5_ No PVC piping for drains, wastes, and vents

Requirements:

- Discuss plumbing options with subcontractor during the design phase to determine best materials your project.
- Provide photographs of drain lines, wastes, vents

Exceptions:

- None

Rationale:

- There is growing concern regarding the health impact of polyvinyl chloride due to the negative environmental impacts of PVC production and dioxin emissions, chemical additives that can leach into the water, or those that off gas into the home environment.
- The adhesive used with PVC is high in emissions and can negatively impact the health of the workers

Considerations:

- The discussion over which piping material is best for drains and the environment is filled with controversy. There is no easy way to compare the benefits of each material (durability, ease of use, product cost) to the negative impacts (pollution created during production, energy and water conservation, long-term durability). While PVC has a high durability potential, the pollution created during production and installation as well as the toxicity of the material if it burns makes its use controversial.

Resources:

- The homeowner or general contractor can verify on-site if plumbing rough-ins are installed.
- California Pipe Study

[Thank You Sponsors - Together We Improve Homes & People's Lives](#)

7D-6_ Install sump pump cover that is airtight and mechanically attached with full gasket seal

Requirements:

- Provide photograph of sump pump

Exceptions:

- None

Rationale:

- Installing a sealed sump pump cover can help reduce the chance of radon and other soil gases from entering the house through the sump basket. However, this seal should not be seen as a substitute for proper testing and installation of a radon mitigation system.

Considerations:

- Check with county agencies to determine the methodology to turn the sump pump system into an active soil gas/radon mitigation system. An active system serves as an energy efficient dehumidifier, and its expense may be offset by a drier basement in the summer.

Resources:

- www.epa.gov/radon

7D-7_ No garbage disposal

Requirements:

- Homeowner is required to sign checklist.

Exceptions:

- None

Rationale:

- Plumbing systems should not include a garbage disposal. Food waste requires a large amount of energy to treat in order to produce potable water. Composting of food wastes is recommended in place of a garbage disposal

Considerations:

- Consider supplying the homeowner with a compost bin for outdoor use and a decorative container to hold compostable materials in the kitchen.

[Thank You Sponsors - Together We Improve Homes & People's Lives](#)

Resources:

- www.greeninstitute.org

8 Interior Finish & Coatings

It is natural when remodeling to think about the end product—what we want to see and experience in our space. There is no shortage of design advice or products from which we can choose. Catalogs, magazines, television, Internet, radio, design professionals, and architects provide an abundant supply of ideas to create a space that uniquely defines who we are.

A remodel, however, should be approached in the same way we think about personal health and wellbeing. A home is a system much like our bodies are systems. No one component acts independently, but rather interacts with some or all of the bigger system. A solid wood floor is connected to the finish that protects it as well as to the subfloor on which it sits. The floor system meets either interior or exterior walls. Attached to the walls and touching the floor may be baseboard or door trim. To be truly Green, we have to think of all of these items and not just the wood that makes up the floor that we see. We also need to consider how each material and its bigger system will impact our health, environment, home, and budget.

As Green design and building evolve, there is a risk that we oversimplify the selection process by relying on advertising information to tell us what is and is not Green. The media and manufacturers are already awash in expressions like environmentally friendly, eco-friendly, Green, recycled, recyclable, all natural, well managed, and healthy. But, what do those definitions truly mean as they relate to energy, water, resource conservation, indoor air quality, or even the bigger picture—the house system? How do we measure the validity of the claims? Is the claim another form of greenwashing—making something that is not Green sound Green for the purpose of persuading someone to make a purchase?

The Minnesota GreenStar certification program was designed to help guide the design and decision process, and identify the meaningful elements of Green design and building. It will not tell you which flooring product to buy—whether the red linoleum is better for your space than the hickory hardwood flooring—but it will provide a means for making informed decisions that connect you to the values of Green, the house as a system, and your own design goals.

Definitions_of_Terms

Calling a product Green is misleading. It is important to note that there are very few, if any, perfect Green products—those that have no impact on the environment, resources, our health,

[Thank You Sponsors - Together We Improve Homes & People's Lives](#)

or our communities. However, products can have a varying degree of Green ATTRIBUTES, and we can define the level of Green of a product by assessing its Green attributes.

For instance, while a product that is lower in emissions is good for air quality, it tells us nothing about the content of the product—how and where it was made, and how it will impact the occupant over time. An example is certified low-emitting carpet. It starts out its life in the space as low emitting, but over time it can promote the growth of mold or promote the collection of dust mites and dander—all contributors to poor indoor air quality. The attribute of being low-emitting also tells us nothing about what happens to the product at the end of its life—will it be sent to a landfill or recycled into more carpet?

But, if we can source a low-emitting product from a local manufacturer that harvested the raw material from a local source that uses best-practice sustainable forestry, the product can be refinished over and over with little impact to the environment, and salvaged at the end of its long life in the space, this product is more Green and more desirable. An example would be locally sourced, certified hardwood flooring with a low-emitting finish that can be salvaged in a fashion that allows it to be reused in another installation.

If you are striving to be Green, look for products that contain as many of the following Green attributes as possible. ALWAYS REMEMBER to choose a product that is appropriate for the space—one that can withstand the occupant use as well as environmental conditions of the home. Green means nothing if the material is wrong for the application. ALWAYS follow manufacturer installation instructions or industry best practices. A Green product that has to be removed due to improper installation is no longer a Green product. In today's world of technology and access to information, claiming ignorance is not an excuse.

Green Attributes of Products:

-
1. **LOCALLY SOURCED** materials are those that are extracted, harvested, or salvaged/recovered AND produced within 500 miles of the project. The goal in returning to locally sourced and produced products is to reduce energy used in transportation as well as to stimulate local economies and jobs. Local materials may have the added advantage of being exclusive to a region thus providing the opportunity for unique or one of a kind design.

In this program, 90% of the material(s) in a product must be locally sourced to receive credit. If the product has multiple materials, the source for all of the materials must be documented.

- www.pca.state.mn.us/oea/rpdir/index.cfm

2. **RECYCLED CONTENT**

- a. Post-consumer material means the original product was used as intended by a consumer, and at the end of its life the product was reused in the production of a new product (e.g., glass from beverage bottles can be used in place of crushed stone aggregate to make

[Thank You Sponsors - Together We Improve Homes & People's Lives](#)

concrete countertops). Post-consumer recycling is the most-preferred type of recycling since the product was actually used as intended and the material recaptured for use as raw material.

b. Post-industrial or pre-consumer material means the original product or raw material never made it to its intended end use. Instead, the material is sent back into the production line to make more of the same product, or it is used as a raw material to manufacture a different product.

- www.pca.state.mn.us/oea/rpdir/index.cfm

3. LOW EMITTING PRODUCTS are designed to be free of or lower in chemical compounds (natural or synthetic), which are released into the air that can negatively impact health and indoor air quality. Many of these compounds including formaldehyde, chlorine, and ammonia can negatively impact health, and their use should be reduced or avoided. They have been linked to increase in allergies, asthma, headaches, and chemical sensitivities. Some products, like formaldehyde, are also linked to cancer.

VOC (volatile organic compound) is a common term that quantifies how much molecular off gassing, or emissions, come from a product. VOCs are what we breathe as a result of a material being in our presence. VOCs are usually listed in grams/liter (g/l)—especially primers, paints, stains, finishes, and glues/adhesives. VOC quantity only tells how much emissions are measured from a product, but not what types of chemicals are being released. It is important to read labels or call a manufacturer’s technical services help line if you want to know the chemical make-up, especially if chemical sensitivity is a concern.

The following websites are helpful for defining thresholds for VOC content:

- www.greenseal.org
- www.chps.net/manual/lem_table.htm#gypsum
- www.aqmd.gov/rules/download.html (choose item XI, choose rules 1101-1196, choose r1168 pdf)

Urea-formaldehyde is one of the most prevalent indoor pollutants. All wood has naturally occurring phenyl formaldehyde. The small quantity is not harmful to humans unless exposed to large quantities of cut wood, such as during milling and sawing. It is recommended that workers take precautions to protect themselves from wood dust during the handling of wood materials.

- www.epa.gov/iaq/formalde.html

Wood materials labeled as “no-added-urea-formaldehyde” (NAUF), also simply know as “no-added-formaldehyde” (NAF) are the best options for wood-based materials such as furniture, cabinetry, closet systems, flooring/sub-flooring, paneling, and counter tops/counter top substrates. NAUF wood materials do not have urea formaldehyde added to the wood glue or other binders. This includes products like particleboard, plywood, medium density fiberboard (MDF), and all other engineered wood products.

[Thank You Sponsors - Together We Improve Homes & People’s Lives](#)

Since it is not always feasible to use wood products labeled as no-added-urea-formaldehyde, all exposed surfaces should be sealed prior to use to reduce formaldehyde exposure.

Non-wood materials are usually labeled as “formaldehyde-free” when glues and adhesives do not contain urea formaldehyde.

Third-party certified low emitting products have gone through rigorous independent testing to measure the off gassing of a product. The testing must follow an established set of standards and be repeatable by any laboratory conducting the test. The following labels on a product can help guide the decision process of selecting low emitting products

- Indoor Advantage (www.greenguard.org)
- Indoor Advantage Gold (www.greenguard.org)
- Greenguard for Schools (www.greenguard.org)
- Floorscore (www.scscertified.com)
- CRI Green Label Plus (www.carpet-rug.org)

4. SALVAGED/RECLAIMED/RECOVERED materials are deconstructed from one site and kept from the waste stream by reuse as is or minimally processed into a new product—such as barn wood re-milled into flooring—at a different site.

Reuse centers and salvage yards are great places to find salvaged product.

This also includes product that was recovered from forgotten or lost material such as submerged timber-cut logs found in a lake.

Materials that came from sources dated before 1978 may contain lead if a finish is present. Have the material tested and ensure worker and jobsite safety when handling and refinishing these products. www.epa.gov/lead

Third-party certified salvaged/reclaimed/recovered materials come from companies that have gone through a rigorous evaluation of their process to recover product and bring it back to market. This type of review helps ensure the authenticity of the product and the integrity of the process. The following labels on a product can help guide the decision process of selecting certified salvaged/reclaimed/recovered product:

- Rediscovered Wood
(www.rainforest-alliance.org/programs/forestry/smartwood/certification/rediscovered-wood.html)
- Certified 100% Salvaged Wood (www.scscertified.com)

[Thank You Sponsors - Together We Improve Homes & People's Lives](#)

5. **RAPIDLY RENEWABLE CONTENT** products are made from rapidly renewable materials—or those materials that regenerate within ten (10) years. These include products such as cork, eucalyptus, palm, wheat board, wool, cotton, jute, coir, bamboo, and linoleum. These materials are wonderful from the perspective that they take a short amount of time to regenerate. Caution must be exercised to be sure the products are grown and harvested in a sustainable fashion and low emitting binders or natural pigments and dyes are used to create the finished product.
6. **Forest Stewardship Council CERTIFIED** wood products are 3rd-party certified to come from sustainably managed, biodiverse forests. This process involves a Forest Stewardship Council Certification (FSC Certification) tracking method whereby each seller along the growing, processing, and distribution routes must be certified and carry a FSC Certification number. FSC Certified lumber and products must be proven to be physically separated from all non FSC Certified lumber and products.

To acquire any credits in the GreenStar program in regards to FSC Certification, the FSC Certification number from the final seller/fabricator must be included with the documentation. For instance, a cabinet shop using FSC Certified wood must provide their FSC Certification number to the general contractor in order for the project to claim the cabinetry as FSC Certified. The same holds true for millwork. The provider of the millwork must provide the FSC Certification number to the general contractor in order for the project to claim the millwork as FSC Certified.

- FSC Certification is a way to significantly reduce Green washing associated with less-than-optimal logging and processing practices such as claiming that replanting one or more trees for every tree harvested is good environmental practice. Replanting is sound business practice for any company that wants to ensure that there is product to harvest from land in the future. But, “planting a tree” tells nothing about the biodiversity of the forest, its ability to sustain plant and animal life, erosion control, or how illegal logging is eradicated.
- The Forest Stewardship Council FSC label is one of the most prominent, international certifications for wood products. In addition to rewarding practices that promote sustainably managed, biodiverse forests, the FSC label also recognizes practices that promote fair wage for all workers involved in the handling of lumber products from the forest to the end holder of the FSC Certification. (www.fsc.org)
- The majority of state owned land in Minnesota is FSC certified making it easier to source FSC hardwood-based products.
- The Sustainable Forestry Initiative Program (SFI) now offers a FSC Certification auditing process for their member products. Be aware that SFI is a membership organization and the “SFI” label is used to indicate members in the organization. To be truly certified through SFI, look for the “certified” label and provide the FSC Certification number. (www.aboutsfi.org)

7. **REFINISH-ABLE/RESURFACE-ABLE** products can be renewed on-site to fix repairs or make the product look like new. Paint is an example of a surface that is easy to repair and

[Thank You Sponsors - Together We Improve Homes & People's Lives](#)

refinish. Hardwood flooring is another example of a material that can be refinished. Stone surfaces can be polished to remove scratches and to renew. There are a variety of Resources for finishing wood products to promote good indoor air quality.

8. REDUCED WASTE products are created through a process that minimizes waste during production. End-run wood flooring is an example whereby boards of improper grade or insufficient quantity are packaged together to create a quantity that is usable in an installation. Finger-joint millwork is a process that reduces waste in production.
- Products made with a process that reduces waste must explain the waste reduction process and provide manufacturer specifications to earn credit

9. CERTIFIED SUSTAINABLE MANUFACTURING PRACTICES While it is important to look at products and their sustainable features, it is also important to support companies and manufacturers that adapt new technologies and systems to lessen their impact on the environment by reducing water, energy, and resource usage, reducing light pollution, and decreasing impact on indoor and outdoor air quality, light pollution, and noise.

Many companies today are claiming that they are Green. It will require hard work and research to wade through the meaning of manufacturer claims if you are not familiar with the manufacturing process or systems used in production. The following labels on a product can help guide the decision process of selecting companies that have gone through a rigorous independent third-party evaluation of their business operations and manufacturing.

- ISO 14001 (www.iso.org)

10. RECYCLABLE products are made of a material that can be easily gathered at the end of its life and reprocessed into more of the same product. It is important the material is a type that is easily recycled without loss of integrity in the new product AND a system must exist to collect the material and deliver it to an existing facility that can process the material. We are familiar with the collection of glass beverage bottles that become new glass beverage bottles. Steel studs can be made into new steel studs.

But few products exist for interior finishes that can be called recyclable. Innovation is fueling new technologies and this area is expected to grow. Nylon 6 fiber in carpeting is an example of a recyclable fiber. The used fiber can be removed from the carpet backing and made into new nylon 6 fiber for a new carpet.

- To receive credit in this program, a product labeled as recyclable must have a process established at the time of installation to collect material, AND a manufacturing or fabrication facility in existence that is actively collecting and reprocessing the material into the same type of material.

11. LIFE CYCLE IMPACT ASSESSMENT (LCIA) is a holistic evaluation of a product and its impact on individual health, communities, the environment, and resources from the beginning of a product's life to its end. The evaluation starts at the beginning of the product life cycle

[Thank You Sponsors - Together We Improve Homes & People's Lives](#)

by examining the process of extraction or harvesting of the raw materials. It then evaluates impact of production, distribution, installation, maintenance, and disposal.

The goal of all products would be to have a low impact throughout the life cycle and ultimately be recyclable in a closed loop; the materials that make up the product are capable of being recycled over and over again into more of the same type of product without loss of integrity and with minimal effort, thereby reducing the need for more raw material and impact that accompanies it.

There are several methodologies available to assess the LCIA of a product including ATHENA and BEES. There are also well-respected third-party certification programs that review products for LCIA. The following websites and certification programs are a guide to finding products or evaluating products.

- athenasmi.ca/ (ATHENA)
- www.bfrl.nist.gov/oea/software/bees/ (BEES)
- www.csbr.umn.edu (Center for Sustainable Building Research)
- www.mcdonough.com/cradle_to_cradle.htm (Cradle to Cradle)
- www.scscertified.com (Sustainable Choice)
- (NSF/ANSI Standard 140-2007)
- www.iso.org (ISO 14040/14044)

8PR-Prerequisites

8PR-1_ During the period between finishing and occupancy, ventilate the building with outside air at the highest rate the ventilation system can produce MINIMUM OF 48 HOURS

Requirements:

- Discuss requirement with the homeowner during the design stage to educate them on its importance to their health and the program.
- Create detailed specification of prerequisite and review with HVAC contractor.
- General contractor and homeowner will initial checklist

Exceptions:

- None

Rationale:

- Many products will release VOCs (volatile organic compounds)* within a short period of installation. Ventilating the home before occupancy will reduce the risk of exposure to these compounds, which is particularly important for those compounds

[Thank You Sponsors - Together We Improve Homes & People's Lives](#)

that may result in allergic or asthmatic reactions such as formaldehyde, chlorine, and ammonia.

Considerations:

- Although a very good way to improve indoor air quality, the chemicals removed from the home can have a negative impact on the outdoor environment. It is wise to choose materials low in VOC to begin with.

Resources:

- www.healthhouse.org/iaq/HomeAirPollutants.pdf

8PR-2_ Suspended/acoustical ceilings are made with recycled materials (at least 60% recycled content may include slag wool, other mineral wools, cellulose and recycled ceiling tiles—non-fiberglass)

Requirements:

- Create detailed specifications that identify preferred ceiling material.
- Provide receipt and material specifications

Exceptions:

- None

Rationale:

- Recycled content material puts less demand on the need for raw material.
- Slag wool is made from a waste product of steel production. Cellulose fiber is made from recycled newspaper.

Considerations:

- None

Resources:

- www.buildinggreen.com/auth/productsByCsiSection.cfm?SubBuilderCategoryID=1959

8PR-3_ No paper-coated drywall in shower or tub surround or other moisture-rich areas

Requirements:

- Create detailed specifications that identify wall treatment.
- Review with installers prior to installation.

Exceptions:

- www.iso.org (ISO 14040/14044)

[Thank You Sponsors - Together We Improve Homes & People's Lives](#)

Rationale:

- Wet or moist paper can provide a food source for mold. This requirement addresses all paper-covered gypsum board including green board.

Considerations:

- None

Resources:

- None

8PR-4_ No vinyl wall coverings allowed in moisture-rich areas such as bathrooms, kitchens, and laundry rooms

Requirements:

- Provide receipt and material specifications

Exceptions:

- None

Rationale:

- The lack of breathability of vinyl wall coverings can allow moisture to be trapped behind the material and provide a favorable habitat for mold growth.

Considerations:

- None

Resources:

- TBD

8PR-5_ All new carpet must be CRI Green Label Plus or third-party certified as low emitting

Requirements:

- Provide receipts and material specifications.

Exceptions:

- None

Rationale:

[Thank You Sponsors - Together We Improve Homes & People's Lives](#)

- According to the carpeting industry, carpet makes up 70% of the flooring materials sold in America. By installing a carpet that is certified as low emitting, it ensures that the product begins its life in the home contributing to better indoor air quality than other carpet choices

Considerations:

- New carpet may start out its life as low emitting, but over time it can become a product that promotes poor indoor air quality. Carpet can collect moisture and bulk water and support the growth of mold. The fibers can trap dust mites and dander, which can irritate asthma and allergy sufferers. It is imperative that carpet is installed in the correct applications and homeowners understand their role in how to care for carpet.

Resources:

- See Definition of Terms at the beginning of Section 8 for more information

8A- Wall and Ceiling Materials

There are many options for covering walls that are beautiful and have Green attributes. Some are more environmentally preferable than others because they have more Green attributes. When making wall and ceiling selections, always begin by taking a minimalist perspective—what provides the greatest amount of protection long-term while having minimal impact yet is still aesthetically pleasing? Can the material be easily repaired so it doesn't have to be replaced? Low or no-emitting paints and natural clays and plasters provide options for good indoor air quality while creating low impact on resources and have proven themselves to have long-term durability. These products are weighted with more points since they would be the preferred minimalist approach in most remodeling situations.

Tile and stone are preferred choices for bulk water areas like shower and tub surrounds since they provide a level of protection that can't be matched by paint, clay, or plaster while also providing a finish that is valued by society and less likely to be replaced than other options.

Walls and ceilings can also be covered in other decorative products like linoleum, metal, glass and resin products, wood and wood composites, agri-based sheet goods, fabric, leather, brick, and wallpaper. However, these products require more resources in their production and often provide more than is needed for function.

Durable wall construction and preparation to accept a finish material is critical for long-term durability, maintenance and cleaning, and overall satisfaction of product installation. Section 2 provides a good reference for information about wall systems. Building codes and industry best practices are also good sources for information.

[Thank You Sponsors - Together We Improve Homes & People's Lives](#)

If you have a product you feel has Green attributes but does not meet any of the following credits, submit a request to have your material or approach considered for an Innovation Credit in section 11. It will be reviewed for potential points.

If you have questions about a product and its Green message, call the technical services phone line of the manufacturer or send an email to a technical services representative to get an answer. They will also be a good source for information on proper specification information and installation.

Remember, no matter how Green a product seems, to be truly durable and long lasting it must be the right product for the application, and installed and maintained correctly.

8A-1_ NOT USED

8A-2_ Use low/no-VOC paint/primer, natural clay, or natural plaster for 50% of the wall/ceiling area (non-tub and shower areas)

Select all that apply:

- 8A-2a_ No VOC primer
- 8A-2b_ Very low VOC primer
- 8A-2c_ Low VOC primer
- 8A-2d_ No VOC paint
- 8A-2e_ Very low VOC paint
- 8A-2f_ Low VOC paint

Requirements:

- No VOC primer is ≤ 5 g/l
- Very low VOC primer is ≤ 50 g/l
- Low VOC primer is ≤ 150 g/L
- No VOC interior paint is ≤ 5 g/l
- Very low VOC interior paint is ≤ 50 g/l
- Low VOC interior paints is \leq than 150 g/L
- Specify dry mix clay or plaster instead of a premixed material.
- Document the square feet of low/no VOC material and the total square feet of project.
- Provide receipts and material specifications

Exceptions:

[Thank You Sponsors - Together We Improve Homes & People's Lives](#)

- Additional points for additional Green attributes for paint, plaster, and clay can be found in the charts for credit 8A - 5 and 8A - 6

Rationale:

- The intent of this credit is to promote the use of low/no-emitting paints and natural clay and plaster for their low impact on air quality and Resources.
- Clay is a readily available, abundant material that has been used for thousands of years as a surfacing material.
- Look for clay that uses natural clay and pigments along with natural mold-inhibiting ingredients like borax

Considerations:

- Different chemical additives are being included in plaster to extend the working time of the material and to make them more flexible over time. These chemicals may emit VOCs* that are harmful to the installers and the occupants.

Resources:

- None

8A-3_ Use low/no-VOC paint/primer, natural clay, or natural plaster for 90% of the wall/ceiling area (non-tub and shower areas)

Select all that apply:

- | | |
|--------|---------------------|
| 8A-3a_ | No VOC primer |
| 8A-3b_ | Very low VOC primer |
| 8A-3c_ | Low VOC primer |
| 8A-3d_ | No VOC paint |
| 8A-3e_ | Very low VOC paint |
| 8A-3f_ | Low VOC paint |

Requirements:

- Specify dry mix clay or plaster instead of a premixed material.
- No VOC primer is ≤ 5 g/l
- Very low VOC primer is ≤ 50 g/l
- Low VOC primer is ≤ 150 g/L
- No VOC interior paint is ≤ 5 g/l
- Very low VOC interior paint is ≤ 50 g/l
- Low VOC interior paints is \leq than 150 g/L
- Document the square feet of low VOC material and the total square feet of project.
- Provide receipts and material specifications

[Thank You Sponsors - Together We Improve Homes & People's Lives](#)

Exceptions:

- Additional points for additional Green attributes for paint, plaster, and clay can be found in the charts in credits 8A - 5 and 8A - 6.
- Rationale:
- The intent of this credit is to promote the use of low/no-emitting paints and natural clay and plaster for their low impact on air quality and resources.
- Clay is a readily available, abundant material that has been used for thousands of years as a surfacing material.
- Look for clay that uses natural clay and pigments along with natural mold-inhibiting ingredients like borax

Considerations:

- Different chemical additives are being included in plaster to extend the working time of the material and to make them more flexible over time. These chemicals may emit VOCs* that are harmful to the installers and the occupants.

Resources:

- None

8A-4_ Install tile or stone for all shower or tub surrounds

Requirements:

- Provide photographs of all shower and tub installations.
- Rater will verify installations

Exceptions:

- None

Rationale:

- Tile or stone installed correctly in a shower or tub surround provides long-term durability and protection from mold.

Considerations:

- Additional points for additional Green attributes for tile can be found in the charts in credits 8A - 5 and 8A - 6. When accessing points in these credits, it will be important to consider the quantity of tile and how it contributes to square foot requirements for those credits.

Resources:

- TBD

8A-5_ Install decorative coverings with 1 or more Green attributes for 50% of the wall/ceiling area (see Requirements)

[Thank You Sponsors - Together We Improve Homes & People's Lives](#)

Select up to 3 sub-credits:

- 8A-5a_ Locally sourced
- 8A-5b_ Contains minimum 25% post-consumer recycled content
- 8A-5c_ Contains minimum 40% post-industrial recycled content
- 8A-5d_ Low emitting or no-added-formaldehyde (NAF or NAUF)
(see Requirements below)
- 8A-5e_ Salvaged/reclaimed/recovered
- 8A-5f_ Rapidly renewable content
- 8A-5g_ Forest Stewardship Council certified
- 8A-5h_ Refinish-able/resurface-able
- 8A-5i_ Certified sustainable manufacturing practice
- 8A-5j_ Life cycle impact assessment

Requirements:

- [Refer to Definition of Terms at the beginning of Section 8 for Green attribute descriptions](#)
- Specify dry mix clay or plaster instead of a premixed material.
- Create detailed plan that identifies wall/ceiling treatment by area.
- Calculate surface area covered with each material and total surface area of project
- Provide receipts and product specifications for all materials
- Certified products will require proof of third-party certification or Forest Stewardship Council Certification (FSC Certification) information
- Locally sourced products will require a map showing location of raw material extraction and manufacturing noting distance to job-site and adherence to definition for the material as outlined in the Definition of Terms at the beginning of Section 8.

Exceptions:

- This credit can be combined with 8A - 2
- This credit can be combined with 8A - 4 as long as the square foot requirements are met.
- If you are using a combination of materials with Green attributes where none of the materials have a quantity that meets this requirement, but together they equal 50% or more, see credit 8A - 7.

Rationale:

- If a wall surface is to receive a decorative product other than paint, clay, or plaster, that surface should have Green attributes so that impact on health and the environment is minimized.

[Thank You Sponsors - Together We Improve Homes & People's Lives](#)

- Since paint, clay, and plaster can have Green attributes beyond their contribution to Indoor Environmental Quality and Resources, this section can be accessed for those additional points.

Considerations:

- When a low emitting product has been installed for air quality reasons, it is important to document product cleaning and maintenance in the homeowner’s manual to maintain good indoor air quality.
- If a product is chosen for its ability to be refinished or resurfaced, it is important to document this in the homeowner’s manual. Provide resources for refinishing or resurfacing.

Resources:

- Refer to Definition of Terms at the beginning of Section 8 for more information as well as Internet references.

8A-6_ Install product with 1 or more Green attributes for 90% of the wall/ceiling area (see Requirements)

Select up to 3 sub-credits:

- 8A-6a_ Locally sourced
- 8A-6b_ Contains minimum 25% post-consumer recycled content
- 8A-6c_ Contains minimum 40% post-industrial recycled content
- 8A-6d_ Low emitting or no-added-formaldehyde (NAF or NAUF)
(see Requirements below)
- 8A-6e_ Salvaged/reclaimed/recovered
- 8A-6f_ Rapidly renewable content
- 8A-6g_ Forest Stewardship Council certified
- 8A-6h_ Refinish-able/resurface-able
- 8A-6i_ Certified sustainable manufacturing practice
- 8A-6j_ Life cycle impact assessment

Requirements:

- [Refer to Definition of Terms at the beginning of Section 8 for Green attribute descriptions](#)
- Create detailed plan that identifies wall/ceiling treatment by area.
- Calculate surface area covered with each material and total surface area of project
- Provide receipts and product specifications for all materials
- Certified products will require proof of third-party certification or Forest Stewardship Council Certification (FSC Certification) information

[Thank You Sponsors - Together We Improve Homes & People’s Lives](#)



- Locally sourced products will require a map showing location of raw material extraction and manufacturing noting distance to job-site

Exceptions:

- This credit can be combined with 8A - 2
- This credit can be combined with 8A - 4 as long as the square foot requirements are met.
- If you are using a combination of materials with Green attributes where none of the materials have a quantity that meets the 50% requirement above, but together they equal 90% or more, See credit 8A - 7.

Rationale:

- If a wall surface is to receive a decorative product other than paint, clay or plaster, that surface should have Green attributes so that its impact on health and the environment is minimized.
- Since paint, clay, and plaster can have Green attributes beyond their contribution to Indoor Environmental Quality, this section can be accessed for those additional points.

Considerations:

- When a low emitting product has been installed for air quality reasons, it is important to document product cleaning and maintenance in the homeowner's manual to maintain good indoor air quality.
- If a product is chosen for its ability to be refinished or resurfaced, it is important to document this in the homeowner's manual. Provide resources for refinishing or resurfacing.

Resources:

- Refer to Definition of Terms at the beginning of Section 8 for more information as well as Internet references.

8A-7_ 50% or 90% of the wall/ceiling surface is covered in a combination of materials that have 1 or more Green attributes

Select one:

- 8A-7a_** 50% of total area
- 8A-7b_** 90% of total area

Requirements:

- This credit cannot be used if the quantity of any product meets the requirements for 8A - 5 or 8A - 6.
-

[Thank You Sponsors - Together We Improve Homes & People's Lives](#)

- Calculate surface area covered with each material and total surface area of project
- Provide receipts and product specifications for all materials
- Certified products will require proof of third-party certification or Forest Stewardship Council Certification (FSC Certification) information
- Locally sourced products will require a map showing location of raw material extraction and manufacturing noting distance to job-site

Exceptions:

- None

Rationale:

- The intent of this credit is to acknowledge that several materials with Green attributes may be used in a space, but none in individual quantity can earn credit. However, when combined they bring value to the project
- An example of this credit would be the finishes in a kitchen - the use of FSC wood paneling on the ceiling (20%), linoleum on an accent wall (20%), low VOC paint on 2 walls (40%), and tile backsplash with 40% recycled content on the remaining exposed wall surface in a kitchen (< 20%). No material meets the criteria for quantity required in 8A - 5 and 8A - 6 to meet the other credits, but together, all the exposed wall and ceiling surfaces were covered in products with a Green attribute.

Considerations:

- None

Resources:

- None

8B-Flooring

There are many options for covering floors that are both beautiful and environmentally preferable. Floors can be covered in products like linoleum, wood and wood composites, bio-based sheet goods, concrete, leather, tile, brick, and stone.

Carpeting is a popular flooring material in America, however, its use is problematic as it ages and becomes a collecting ground for dust mites and dander. Carpet pad and carpet fiber can also trap moisture and bulk water leading to the promotion of mold growth. The preferred method for healthy indoor air quality is hard surface flooring. Area rugs can be removed for cleaning as needed.

If the reason for choosing carpeting is to improve the perceived warmth of a floor, it is best to investigate the reasons for a cold room before investing in carpet. Does the room have balanced airflow so that conditioned (hot or cold) air can move in and out of the room easily? Are there

[Thank You Sponsors - Together We Improve Homes & People's Lives](#)

enough vents and cold air returns? Is there enough insulation in the walls? Have all areas been properly air sealed? A Blower Door Test and infrared camera scan would be wise investments for comfort and long-term energy efficiency. See section 4 for more information.

Carpet is often requested for basements where it could not possibly be installed in a more problematic location. As basements are already at a big risk for bulk water and moisture management, almost any material is preferable to carpet. Avoid installing carpet of any type in a basement.

If you have a product you feel has Green attributes but does not fall into any of the following categories, submit your material and the quantity used as an Innovation Credit in section 11. It will be reviewed for potential points.

If you have questions about a product and its Green message, call the technical services phone line of a manufacturer or send an email to a technical services representative to get an answer. They will also be a good source for information on proper specification information and installation.

Remember, no matter how Green a product seems, to be truly durable and long lasting, it must be the right product for the application, and installed and maintained correctly.

8B-1_ No wall-to-wall carpet in bathrooms, kitchens, entryways and utility rooms

Requirements:

- Choose hard surface flooring that can withstand moisture and heavy cleaning over time.
- Create detailed plan that identifies flooring material by area.

Exceptions:

- None

Rationale:

- Carpet and the pad underneath can act like a sponge and absorb moisture, bulk water, and airborne contaminants commonly found in these areas of the home.
- Trapped moisture can promote mold growth and dust mites. Both of these living organisms are known for causing a variety of health issues including sensitivities, allergies, and asthmatic reactions.
- Carpet and pad do not allow for thorough cleaning of these dirt-prone areas of the home.

Considerations:

- None

[Thank You Sponsors - Together We Improve Homes & People's Lives](#)

Resources:

- www.lungusa.com

8B-2_ Install all hard-surface flooring (no carpet)

Requirements:

- Specify hard surface flooring that has no-added urea-formaldehyde, is formaldehyde-free (non-wood products), or is third-party certified as low emitting.
- The finish on a hardwood floor must be ≤ 250 g/l VOC.
- Provide floor plan and indicate all flooring surfaces by name and product type.
- Provide receipt and product specifications for all materials.

Exceptions:

- None

Rationale:

- Hard surface flooring is easier to maintain than carpet and does not harbor dust mites—a contributor to allergies and asthma.
- There are many flooring options, but they are not all made the same. It is important to choose floor coverings that promote good indoor air quality—those that do not contain formaldehyde, vinyl or other toxic chemicals.

Considerations:

- None

Resources:

- None

8B-3_ Install tile, glass, or stone for all shower flooring

Requirements:

- Provide photographs of all shower installations.
- Rater will verify installations

Exceptions:

- None

Rationale:

- Tile or stone installed correctly in a shower provides long-term durability and protection from mold.

[Thank You Sponsors - Together We Improve Homes & People's Lives](#)

Considerations:

- Additional points for additional Green attributes for tile can be found in the charts in credits 8B - 8 and 8B - 9. When accessing points in these credits, it will be important to consider the quantity of tile and how it contributes to square foot requirements for those credits.

Resources:

- TBD

8B-4_ Seal concrete floors (minimum 80% of interior finish slab-work)

Requirements:

- Create detailed plan that identifies flooring material by area.
- Document surface area covered with concrete and total surface area of project
- Provide description of products and receipt.

Exceptions:

- This credit also applies to an existing concrete floor that is uncovered, cleaned, and sealed
- Additional points for additional Green attributes for sealed concrete can be found in the charts in credits 8B - 8 and 8B - 9. When accessing points in these credits, it will be important to consider the quantity of concrete and how it contributes to square foot requirements for those credits.

Rationale:

- Concrete can be left natural or stained to add color and pattern providing a unique design without the need for an additional floor covering.

Considerations

- Consider using fly ash (minimum 25%) as a replacement to the Portland cement in concrete. This helps to divert the fly ash waste from a landfill.

Resources:

- www.concretenetwork.com

8B-5_ Underlayment contains no added urea-formaldehyde (NAF or NAUF)

Requirements:

- Create detailed plan that identifies flooring and sub-flooring products by area.
- Provide receipt and material specifications

[Thank You Sponsors - Together We Improve Homes & People's Lives](#)

Exceptions:

- None

Rationale:

- All wood has naturally occurring formaldehyde. The small quantity is not harmful to humans unless exposed to large quantities of cut wood, such as during milling and sawing. It is recommended that workers take precautions to protect themselves from wood dust during the handling of wood materials.
- Homeowners can protect themselves by choosing wood-based materials that do not have formaldehyde added to the glue. Choosing these materials will reduce the health risks associated with exposure to this known carcinogen.

Considerations:

- When the decision has been made to install a no-added formaldehyde flooring product for air quality reasons, it is important that the underlayment also address air quality issues

Resources:

- www.epa.gov/iaq/formalde.html

8B-6_ Use low VOC carpet glue

Requirements:

- Specify a low VOC carpet adhesive—defined by the Green Seal standard as one that is ≤ 150 grams/liter (minus water) of VOC
- Provide receipt and material specifications

Exceptions:

- None

Rationale:

- The surface area of a floor is a large area that can create an indoor air quality problem if the adhesive used to cover the space emits a high volume of VOC.

Considerations:

- None

Resources:

- www.greenseal.org/certification/standards/commercialadhesives.cfm

8B-7_ Tile installed over poured cementitious bed with lathe

[Thank You Sponsors - Together We Improve Homes & People's Lives](#)

Requirements:

- Provide detailed plan that identifies areas to receive cementitious bed and lathe.
- Document with a photograph during installation of each step in process.

Considerations:

- None

Rationale:

- Many tile durability problems can be avoided by using the proper sub-base. Wood is not an appropriate sub-base for tile as it expands and contracts with temperature and humidity increasing the risk of cracking in the tile or grout. A poured cementitious bed with lathe is a proven durable base for tile and other alternatives.

Considerations:

- None

Resources:

- TBD

8B-8_ Install product with 1 or more Green attributes for 50% of the floor area (see Requirements)

Select up to 3 sub-credits:

- 8B-8a_** Locally sourced
- 8B-8b_** Contains minimum 25% post-consumer recycled content
- 8B-8c_** Contains minimum 40% post-industrial recycled content
- 8B-8d_** Low emitting or no-added-urea-formaldehyde (NAUF) (see Requirements)
- 8B-8e_** Salvaged/reclaimed/recovered
- 8B-8f_** Rapidly renewable content
- 8B-8g_** Forest Stewardship Council certified
- 8B-8h_** Refinish-able/resurface-able
- 8B-8i_** Reduced waste in manufacturing
- 8B-8j_** Recyclable
- 8B-8k_** Certified sustainable manufacturing practice
- 8B-8l_** Life cycle impact assessment

Requirements:

- [Refer to Definition of Terms at the beginning of Section 8 for Green attribute descriptions](#)
- If certified low emitting carpeting is used, the pad must also be certified low emitting and any glues must be \leq 150grams/liter VOC to receive credit

[Thank You Sponsors - Together We Improve Homes & People's Lives](#)

- Create detailed plan that identifies flooring by area.
- Calculate surface area covered with each material and total surface area of project
- Provide receipts and product specifications for all materials
- Certified products will require proof of third-party certification or Forest Stewardship Council Certification (FSC Certification) information
- Locally sourced products will require a map showing location of raw material extraction and manufacturing noting distance to job-site
- Recyclable materials will require documentation for collection method and manufacturing facility. Information on how to recycle an installed material must be included in the homeowner's manual

Exceptions:

- This credit can be combined with 8B - 2
- This credit can be combined with 8B - 3 as long as the square foot requirements are met.
- This credit can be combined with 8B - 4
- If you are using a combination of materials with Green attributes where none of the materials have a quantity that meets the 50% requirement above, but together they equal 50% or more, see credit 8B - 10

Rationale:

- None

Considerations:

- When a low emitting product has been installed for air quality reasons, it is important to document product cleaning and maintenance in the homeowner's manual to maintain good indoor air quality.
- If a product is chosen for its ability to be refinished or resurfaced, it is important to document this in the homeowner's manual. Provide resources for refinishing or resurfacing.

Resources:

- Refer to Definition of Terms at the beginning of Section 8 for more information as well as Internet references.

8B-9_ Install product with 1 or more Green attributes for 90% of the floor area (see Requirements)

Select up to 3 sub-credits:

- 8B-9a_** Locally sourced
- 8B-9b_** Contains minimum 25% post-consumer recycled content

[Thank You Sponsors - Together We Improve Homes & People's Lives](#)



8B-9c_	Contains minimum 40% post-industrial recycled content
8B-9d_	Low emitting or no-added-formaldehyde (NAF or NAUF) (see Requirements below)
8B-9e_	Salvaged/reclaimed/recovered
8B-9f_	Rapidly renewable content
8B-9g_	Forest Stewardship Council certified
8B-9h_	Refinish-able/resurface-able
8B-9i_	Reduced waste in manufacturing
8B-9j_	Recyclable
8B-9k_	Certified sustainable manufacturing practice
8B-9l_	Life cycle impact assessment

Requirements:

- Refer to Definition of Terms at the beginning of Section 8 for Green attribute descriptions
- If certified low emitting carpeting is used, the pad must also be certified low emitting to receive credit
- Create detailed plan that identifies flooring by area.
- Calculate surface area covered with each material and total surface area of project
- Provide receipts and product specifications for all materials
- Certified products will require proof of third-party certification or Forest Stewardship Council Certification (FSC Certification) information
- Locally sourced products will require a map showing location of raw material extraction and manufacturing noting distance to job-site
- Recyclable materials will require documentation for collection method and manufacturing facility. Information on how to recycle an installed material must be included in the homeowner's manual

Exceptions:

- This credit can be combined with 8B - 2.
- This credit can be combined with 8B - 3 as long as the square foot requirements are met.
- This credit can be combined with 8B - 4 as long as the square foot requirements are met.
- If you are using a combination of materials with Green attributes where none of the materials have a quantity that meets the 50% requirement above, but together they equal 50% or more, see credit 8B - 10

Rationale:

- None

Considerations:

[Thank You Sponsors - Together We Improve Homes & People's Lives](#)

- When a low emitting product has been installed for air quality reasons, it is important to document product cleaning and maintenance in the homeowner's manual to maintain good indoor air quality.
- If a product is chosen for its ability to be refinished or resurfaced, it is important to document this in the homeowner's manual. Provide resources for refinishing or resurfacing.

Resources:

- Refer to Definition of Terms at the beginning of Section 8 for more information as well as Internet references.

8B-10_ 50% or 90% of flooring is in a combination of materials that have 1 or more Green attributes

Select one:

- 8B-10a_** 50% of total area
- 8B-10b_** 90% of total area

Requirements:

- This credit cannot be used if the quantity of any product meets the requirements for 8B-8 or 8B-9.
- All square foot quantities of total surface area and square foot area of the products with Green attributes must be calculated
- Provide receipts, material specifications, maps, certifications, FSC Certification

Exceptions:

- None

Rationale:

- The intent of this credit is to acknowledge that several materials with Green attributes may be used in a space, but none in individual quantity can earn credit. However, when combined they bring value to the project
- An example of this credit would be the flooring for a whole house - the use of FSC wood in the kitchen (10%), linoleum in 2 bathrooms and laundry (15%), tile floor with 40% recycled content in 2 bathrooms and main entry (10%), sealed concrete floor in lower-level (25%). No material meets the criteria for 8B-8, but together, all flooring was covered in product with a Green attribute.

Considerations:

- None

Resources:

[Thank You Sponsors - Together We Improve Homes & People's Lives](#)

- TBD

8C-Millwork and Doors

There are many options to choose from when selecting these finishing elements. They can be beautiful while being better for the environment and health compared to other options. If you have a product you feel has Green attributes but does not fall into any of the following categories, submit your material and the quantity used as an Innovation Credit in section 11. It will be reviewed for potential points.

If you have questions about a product and its Green message, call the technical services phone line of a manufacturer or send an email to a technical services representative to get an answer. They will also be a good source for information on proper specification information and installation.

Remember, no matter how Green a product seems, to be truly durable and long lasting, it must be the right product for the application and must be installed and maintained correctly.

8C-1_ 50% of millwork has 1 or more Green attributes (see Requirements)

Select up to 3 sub-credits:

8C-1a_	Locally sourced
8C-1b_	Contains minimum 25% post-consumer recycled content
8C-1c_	Contains minimum 40% post-industrial recycled content
8C-1d_	Low emitting or no-added-formaldehyde (NAF or NAUF) (see Requirements below)
8C-1e_	Salvaged/reclaimed/recovered
8C-1f_	Rapidly renewable content
8C-1g_	Forest Stewardship Council certified
8C-1h_	Reduced waste in manufacturing
8C-1i_	Certified sustainable manufacturing practice
8C-1j_	Life cycle impact assessment

Requirements:

- [Refer to Definition of Terms at the beginning of Section 8 for Green attribute descriptions](#)
 - The stains and sealers on millwork must be ≤ 250 g/l VOC
 - Create detailed plan that identifies millwork by area.
 - Calculate linear feet of each material and total linear feet of project
-

[Thank You Sponsors - Together We Improve Homes & People's Lives](#)

- Provide receipts and product specifications for all materials
- Certified products will require proof of third-party certification or Forest Stewardship Council Certification (FSC Certification) information
- Locally sourced products will require a map showing location of raw material extraction and manufacturing noting distance to job-site

Exceptions:

- If you are using a combination of materials with Green attributes where none of the materials have a quantity that meets the 50% requirement above, but together they equal 50% or more, see credit 8C - 3.

Rationale:

- None

Considerations:

- None

Resources:

- Refer to Definition of Terms at the beginning of Section 8 for more information as well as Internet references.
- <http://www.healthybuilding.net/healthcare/No%20Added%20Formaldehyde%20Casework.pdf>

8C-2_ 90% of millwork has 1 or more Green attributes (see Requirements)

Select up to 3 sub-credits:

- 8C-2a_ Locally sourced
- 8C-2b_ Contains minimum 25% post-consumer recycled content
- 8C-2c_ Contains minimum 40% post-industrial recycled content
- 8C-2d_ Low emitting or no-added-formaldehyde (NAF or NAUF)
(see Requirements below)
- 8C-2e_ Salvaged/reclaimed/recovered
- 8C-2f_ Rapidly renewable content
- 8C-2g_ Forest Stewardship Council certified
- 8C-2h_ Reduced waste in manufacturing
- 8C-2i_ Certified sustainable manufacturing practice
- 8C-2j_ Life cycle impact assessment

Requirements:

- [Refer to Definition of Terms at the beginning of section 8 for Green attribute descriptions](#)
 - The stains and sealers on millwork must be \leq 250 g/l VOC
-

[Thank You Sponsors - Together We Improve Homes & People's Lives](#)



- Create detailed plan that identifies millwork by area.
- Calculate linear feet of each material and total linear feet of project
- Provide receipts and product specifications for all materials
- Certified products will require proof of third-party certification or Forest Stewardship Council Certification (FSC Certification) information
- Locally sourced products will require a map showing location of raw material extraction and manufacturing noting distance to job-site

Exceptions:

- If you are using a combination of materials with Green attributes where none of the materials have a quantity that meets the 50% requirement above, but together they equal 50% or more, see credit 8C - 3.

Rationale:

- None

Considerations:

- None

Resources:

- Refer to Definition of Terms at the beginning of Section 8 for more information as well as Internet references.

8C-3_ 50% or 90% of millwork is in a combination of materials that have 1 or more Green attributes

Select one:

- 8C-3a_ 50% of total millwork**
8C-3b_ 90% of total millwork

Requirements:

- This credit cannot be used if the quantity of any product meets the requirements of 8C - 1 or 8C - 2.
- Calculate linear feet of each material and total linear feet of project
- Provide receipts and product specifications for all materials
- Certified products will require proof of third-party certification or Forest Stewardship Council Certification (FSC Certification) information
- Locally sourced products will require a map showing location of raw material extraction and manufacturing noting distance to job-site

[Thank You Sponsors - Together We Improve Homes & People's Lives](#)

Exceptions:

- None

Rationale:

- The intent of this credit is to acknowledge that several materials with Green attributes may be used in a space, but none in individual quantity can earn credit. However, when combined they bring value to the project
- An example of this credit would be the millwork for a whole house - the use of FSC millwork in the living room and dining room (45%), finger-joint millwork in bedrooms (40%), bamboo in kitchen and laundry (10%). No single material meets all the criteria for 8C - 1 above, but together, 90% of millwork has some Green attribute.

Considerations:

- None

Resources:

- None

8C-4_ 50% of interior doors have 1or more Green attributes (see Requirements)

Select up to 3 sub-credits:

- 8C-4a_ Locally sourced
- 8C-4b_ Contains minimum 25% post-consumer recycled content
- 8C-4c_ Contains minimum 40% post-industrial recycled content
- 8C-4d_ Low emitting or no-added-formaldehyde (NAF or NAUF)
(see Requirements below)
- 8C-4e_ Salvaged/reclaimed/recovered
- 8C-4f_ Rapidly renewable content
- 8C-4g_ Forest Stewardship Council certified
- 8C-4h_ Reduced waste in manufacturing
- 8C-4i_ Certified sustainable manufacturing practice
- 8C-4j_ Life cycle impact assessment

Requirements:

- [Refer to Definition of Terms at the beginning of Section 8 for Green attribute descriptions](#)
- Create detailed plan that identifies doors by area in project
- Provide receipts and product specifications for all doors
- Certified products will require proof of third-party certification or Forest Stewardship Council Certification (FSC Certification) information
- Locally sourced products will require a map showing location of raw material extraction and manufacturing noting distance to job-site

[Thank You Sponsors - Together We Improve Homes & People's Lives](#)

Exceptions:

- None

Rationale:

- None

Considerations:

- When a low emitting product has been installed for air quality reasons, it is important to document product cleaning and maintenance in the homeowner's manual to maintain good indoor air quality.
- If a product is chosen for its ability to be refinished or resurfaced, it is important to document this in the homeowner's manual. Provide resources for refinishing or resurfacing.

Resources:

- Refer to Definition of Terms at the beginning of Section 8 for more information as well as Internet references.

8C-5_ 90% of interior doors have 1 or more Green attributes (see Requirements)

Select up to 3 sub-credits:

- 8C-5a_ Locally sourced
- 8C-5b_ Contains minimum 25% post-consumer recycled content
- 8C-5c_ Contains minimum 40% post-industrial recycled content
- 8C-5d_ Low emitting or no-added-formaldehyde (NAF or NAUF)
(see Requirements below)
- 8C-5e_ Salvaged/reclaimed/recovered
- 8C-5f_ Rapidly renewable content
- 8C-5g_ Forest Stewardship Council certified
- 8C-5h_ Reduced waste in manufacturing
- 8C-5i_ Certified sustainable manufacturing practice
- 8C-5j_ Life cycle impact assessment

Requirements:

- [Refer to Definition of Terms at the beginning of Section 8 for Green attribute descriptions](#)
- Create detailed plan that identifies doors by area in project
- Provide receipts and product specifications for all doors
- Certified products will require proof of third-party certification or Forest Stewardship Council Certification (FSC Certification) information

[Thank You Sponsors - Together We Improve Homes & People's Lives](#)

- Locally sourced products will require a map showing location of raw material extraction and manufacturing noting distance to job-site

Exceptions:

- None

Rationale:

- None

Considerations:

- When a low emitting product has been installed for air quality reasons, it is important to document product cleaning and maintenance in the homeowner's manual to maintain good indoor air quality.
- If a product is chosen for its ability to be refinished or resurfaced, it is important to document this in the homeowner's manual. Provide resources for refinishing or resurfacing.

Resources:

- Refer to Definition of Terms at the beginning of Section 8 for more information as well as Internet references.

8C-6_ 50% or 90% of interior doors are in a combination of materials that have 1 or more Green attributes

Select one:

- 8C-6a_** 50% of total interior doors
- 8C-6b_** 90% of total interior doors

Requirements:

- This credit cannot be used if the quantity of any product meets the requirements of 8C - 4 or 8C - 5.
- Create detailed plan identifying door types
- Provide receipts and product specifications for all materials
- Certified products will require proof of third-party certification or Forest Stewardship Council Certification (FSC Certification) information
- Locally sourced products will require a map showing location of raw material extraction and manufacturing noting distance to job-site

Exceptions:

- None
-

[Thank You Sponsors - Together We Improve Homes & People's Lives](#)

Rationale:

- The intent of this credit is to acknowledge that several materials with Green attributes may be used in a space, but none in individual quantity can earn credit. However, when combined they bring value to the project
- An example of this credit would be the doors for a whole house: the use of FSC doors in the bedrooms (45%), locally extracted oak doors for hall closets (40%) and salvaged doors for bathrooms (15%). No single material meets all the criteria for 8C-4 above, but together, 90% of doors has some Green attribute.

Considerations:

- None

Resources:

- TBD

8D- Countertops

There are many options for countertops that are both beautiful and environmentally preferable. Some of these options include wood, stone, tile, solid glass and recycled glass, metal, bamboo, linoleum, concrete, and recycled paper.

If you have a product you feel has Green attributes but does not fall into any of the following categories, submit your material and the quantity used as an Innovation Credit in section 11. It will be reviewed for potential points.

If you have questions about a product and its Green message, call the technical services phone line of the manufacturer or send an email to a technical services representative to get an answer. They will also be a good source for information on proper specification information and installation.

Remember, no matter how Green a product seems, to be truly durable and long lasting, it must be the right product for the application and must be installed and maintained correctly.

8D-1_ Install product with 1 or more Green attributes for 50% of the countertop area (see Requirements)

Select up to 3 sub-credits:

- 8D-1a_** Locally sourced
- 8D-1b_** Contains minimum 25% post-consumer recycled content
- 8D-1c_** Contains minimum 40% post-industrial recycled content

[Thank You Sponsors - Together We Improve Homes & People's Lives](#)

8D-1d_	Low emitting or no-added-formaldehyde (NAF or NAUF) (see Requirements below)
8D-1e_	Salvaged/reclaimed/recovered
8D-1f_	Rapidly renewable content
8D-1g_	Forest Stewardship Council certified
8D-1h_	Refinish-able/resurface-able
8D-1i_	Reduced waste in manufacturing
8D-1j_	Recyclable
8D-1k_	Certified sustainable manufacturing practice
8D-1l_	Life cycle impact assessment

Requirements:

- [Refer to Definition of Terms at the beginning of Section 8 for Green attribute descriptions](#)
- Solid surface countertops that contain less than 7% petroleum by volume
- Create detailed plan that identifies countertops by area.
- Calculate surface area covered with each material and total surface area of project
- Provide receipts and product specifications for all materials
- Certified products will require proof of third-party certification or Forest Stewardship Council Certification (FSC Certification) information
- Locally sourced products will require a map showing location of raw material extraction and manufacturing noting distance to job-site
- Recyclable materials will require documentation for collection method and manufacturing facility. Information on how to recycle an installed material must be included in the homeowner's manual

Exceptions:

- If you are using a combination of materials with Green attributes where none of the materials have a quantity that meets the 50% requirement above, but together they equal 50% or more, See credit 8D-3.

Rationale:

- None

Considerations:

- When a low emitting product has been installed for air quality reasons, it is important to document product cleaning and maintenance in the homeowner's manual to maintain good indoor air quality.
- If a product is chosen for its ability to be refinished or resurfaced, it is important to document this in the homeowner's manual. Provide resources for refinishing or resurfacing.

Resources:

[Thank You Sponsors - Together We Improve Homes & People's Lives](#)

- Refer to Definition of Terms at the beginning of Section 8 for more information as well as Internet references.

8D-2_ Install product with 1 or more Green attributes for 90% of the countertop area (see Requirements)

Select up to 3 sub-credits:

- 8D-2a_ Locally sourced
- 8D-2b_ Contains minimum 25% post-consumer recycled content
- 8D-2c_ Contains minimum 40% post-industrial recycled content
- 8D-2d_ Low emitting or no-added-formaldehyde (NAF or NAUF)
(see Requirements below)
- 8D-2e_ Salvaged/reclaimed/recovered
- 8D-2f_ Rapidly renewable content
- 8D-2g_ Forest Stewardship Council certified
- 8D-2h_ Refinish-able/resurface-able
- 8D-2i_ Reduced waste in manufacturing
- 8D-2j_ Recyclable
- 8D-2k_ Certified sustainable manufacturing practice
- 8D-2l_ Life cycle impact assessment

Requirements:

- [Refer to Definition of Terms at the beginning of Section 8 for Green attribute descriptions](#)
- Solid surface countertops will contain less than 7% petroleum by volume
- Create detailed plan that identifies countertops by area.
- Calculate surface area covered with each material and total surface area of project
- Provide receipts and product specifications for all materials
- Certified products will require proof of third-party certification or Forest Stewardship Council Certification (FSC Certification) information
- Locally sourced products will require a map showing location of raw material extraction and manufacturing noting distance to job-site
- Recyclable materials will require documentation for collection method and manufacturing facility. Information on how to recycle an installed material must be included in the homeowner's manual

Exceptions:

- If you are using a combination of materials with Green attributes where none of the materials have a quantity that meets the 50% requirement above, but together they equal 50% or more, see credit 8D - 3.

Rationale:

[Thank You Sponsors - Together We Improve Homes & People's Lives](#)

- None

Considerations:

- When a low emitting product has been installed for air quality reasons, it is important to document product cleaning and maintenance in the homeowner's manual to maintain good indoor air quality.
- If a product is chosen for its ability to be refinished or resurfaced, it is important to document this in the homeowner's manual. Provide resources for refinishing or resurfacing.

Resources:

- Refer to Definition of Terms at the beginning of Section 8 for more information as well as Internet references.

8D-3_ 50% or 90% of countertops are in a combination of materials that have 1 or more Green attributes

Select one:

- 8D-3a_** 50% of total area
- 8D-3b_** 90% of total area

Requirements:

- This credit cannot be used if the quantity of any product meets the requirements of 8D - 1 or 8D - 2.
- All square foot quantities of total surface area and square foot area of the products with Green attributes must be calculated
- Provide receipts, material specifications, maps, certifications, FSC Certification

Exceptions:

- None

Rationale:

- The intent of this credit is to acknowledge that several materials with Green attributes may be used in a space, but none in individual quantity can earn credit. However, when combined they bring value to the project
- An example of this credit would be the countertops in a whole house: the use of bamboo countertops in the kitchen (40%), linoleum countertops in 2 bathrooms and laundry (40%), remnant stone countertops in a third bathroom and bar area (20%). No material meets all the criteria for 8B-2, but together, all the products have some Green attributes.

Considerations:

- None
-

[Thank You Sponsors - Together We Improve Homes & People's Lives](#)

Resources:

- TBD

8D-4_ Wood substrate for countertop has no-added urea-formaldehyde

Requirements:

- Provide receipt and material specifications

Exceptions:

- None

Rationale:

- Many composite wood products like particleboard and plywood are made with adhesives that can contain urea-formaldehyde. It is better for indoor air quality to use a wood substrate for laminate or linoleum that does not have urea-formaldehyde added to the adhesives.

Considerations:

- None

Resources:

- None

8E- Cabinetry

The cabinet system is composed of the carcass or box, possible face frame, doors, and shelving. See Subsection 8F on ways to finish products to maintain good indoor air quality. Since many closet systems resemble cabinetry, they are considered part of the cabinetry and thus a part of all calculations for cabinetry.

If you have a product you feel has Green attributes but does not fall into any of the following categories, submit your material and the quantity used as an Innovation Credit in section 11. It will be reviewed for potential points.

If you have questions about a product and its Green message, call the technical services phone line or send an email to a technical services representative to get an answer. They will also be a good source for information on proper specification information and installation.

Remember, no matter how Green a product seems, to be truly durable and long lasting, it must be the right product for the application and must be installed and maintained correctly.

[Thank You Sponsors - Together We Improve Homes & People's Lives](#)

8E-1_ 90% of cabinetry has 1 or more Green attributes (see Requirements)

Select all that apply:

- 8E-1a_ Locally sourced
- 8E-1b_ Contains minimum 40% post-industrial recycled content
- 8E-1c_ Low emitting or no-added-formaldehyde (NAF or NAUF)
(see Requirements below)
- 8E-1d_ Salvaged/reclaimed/recovered
- 8E-1e_ Rapidly renewable content
- 8E-1f_ Forest Stewardship Council certified
- 8E-1g_ Reduced waste in manufacturing
- 8E-1h_ Certified sustainable manufacturing practice
- 8E-1i_ Life cycle impact assessment

Requirements:

- [Refer to Definition of Terms at the beginning of Section 8 for Green attribute descriptions](#)
- Create detailed plan that identifies cabinetry by area.
- Calculate linear feet of cabinetry in project area
- Provide receipts and product specifications for all materials
- Certified products will require proof of third-party certification or Forest Stewardship Council Certification (FSC Certification) information
- Locally sourced products will require a map showing location of raw material extraction and manufacturing noting distance to job-site

Exceptions:

- None

Rationale:

- See the Definition of Terms at the beginning of Section 8 to understand the reasoning for each of the Green attributes below.

Considerations:

- None

Resources:

- Refer to Definition of Terms at the beginning of Section 8 for more information as well as Internet references.
- <http://www.healthybuilding.net/healthcare/No%20Added%20Formaldehyde%20Casework.pdf>

[Thank You Sponsors - Together We Improve Homes & People's Lives](#)

8E-2_ 90% of cabinetry is in a combination of materials that have 1 or more Green attributes

Requirements:

- This credit cannot be used if the quantity of any product meets the requirements 8C-? above.
- Create detailed plan that identifies cabinetry by area
- Provide receipts and product specifications for all materials
- Certified products will require proof of third-party certification or Forest Stewardship Council Certification (FSC Certification) information
- Locally sourced products will require a map showing location of raw material extraction and manufacturing noting distance to job-site

Exceptions:

- None

Rationale:

- The intent of this credit is to acknowledge that several materials with Green attributes may be used in a space, but none in individual quantity can earn credit. However, when combined they bring value to the project

Considerations:

- None

Resources:

- www.healthybuilding.net/healthcare/No%20Added%20Formaldehyde%20Casework.pdf

8E-3_ Seal all edges of cabinetry not labeled as “no-added urea-formaldehyde” prior to assembly

Requirements:

- Purchase product designed specifically to seal formaldehyde in wood.
- Provide receipt and material specifications.
- General contractor and homeowner will initial checklist

Exceptions:

- None

Rationale:

- All wood has naturally occurring urea-formaldehyde. The small quantity is not harmful to humans unless exposed to large quantities of cut wood, such as during milling and

[Thank You Sponsors - Together We Improve Homes & People's Lives](#)

sawing. It is recommended that workers take precautions to protect themselves from wood dust during the handling of wood materials.

- Homeowners can protect themselves by choosing wood-based materials (furniture, cabinetry, flooring/sub-flooring, counter tops) that do not have urea-formaldehyde added to the glue or other binders. Choosing these materials will reduce the health risks associated with exposure to this known carcinogen.
- When you are not able to purchase new cabinetry that has no-added urea-formaldehyde, sealing exposed edges and surfaces will help to lessen the negative impact of formaldehyde but may not eliminate it.

Considerations:

- None

Resources:

- www.epa.gov/iaq/formalde.html

8F-Coatings and Adhesives

VOC* stands for Volatile Organic Compound. These are chemicals, naturally occurring and man-made, that are released into the air from a product. Many of these compounds including formaldehyde, chlorine, and ammonia can negatively impact health, and their use should be reduced or avoided.

To help consumers understand the potential impact of a product on health, VOC quantity is often listed on a container in grams/liter (g/l). It is important to read product labels. The quantity of VOC, measured in grams/liter (gl), tells us nothing about the actual materials in a product. For some people who suffer from asthma or are chemically sensitive, the type of chemical released into the air is just as important as the amount. If the materials are not listed on a product, call the technical services line of a manufacturer to get information.

The terms “low emitting” and “off gassing” are also used to describe the chemicals that are released into the air from a product.

8F-1_ Supply workers with VOC protection

Requirements:

- Create and post a job-site plan that explains the materials to be used and the type of worker protection required for each material.
- Provide worker protection in an accessible location.

Exceptions:

[Thank You Sponsors - Together We Improve Homes & People's Lives](#)

- None

Rationale:

- Health of the workers is as important as the health of the occupants. Many systems exist to protect workers from inhaling VOCs* and construction dust.
- Use respirators rated for the material being handled.

Considerations:

- None

Resources:

- www.health.state.mn.us

8F-2_ Adhesives are urea-formaldehyde free

Requirements:

- Provide receipt and material specifications

Exceptions:

- None

Rationale:

- Adhesives that are formaldehyde-free are better for the workers as well as for the occupants
- The MSDS, or Material Safety Data Sheet, of a product is a good source for determining product content.

Considerations:

- Many installers have a comfort level with certain adhesive brands because of positive experience in regards to performance. As with any new product, the product should be reviewed with an installer and tested prior to installation.

Resources:

- TBD

8F-3_ Caulks are low VOC (minimum 75% of caulk applications)

Requirements:

- Provide receipt and material specifications

Exceptions:

[Thank You Sponsors - Together We Improve Homes & People's Lives](#)

- None

Rationale:

- Caulks that are low VOC are better for workers as well as for the occupants
- The MSDS, or Material Safety Data Sheet, of a product is a good source for determining product content and VOC quantity. This can be sourced through the Internet or the technical services phone line of a manufacturer.

Considerations:

- Many installers have a comfort level with certain caulk brands because of positive experience in regards to performance. As with any new product, the product should be reviewed with an installer and tested prior to installation.

Resources:

- TBD

[Thank You Sponsors - Together We Improve Homes & People's Lives](#)

9_Waste_Management

Introduction to Waste Management Strategies:

Waste management strategy is currently best expressed in the 3 R's: Reduce, Reuse and Recycle. This hierarchy is crucial in minimizing the depletion of natural resources and the environmental problems associated with non-sustainable practices.

Reducing the scope and size of a remodeling project at the beginning will reduce the amount of raw materials needed while also eliminating the embodied energy costs completely for the materials not used. This is by far the most effective Green action that can be taken. Reusing and recycling are the remaining strategies and are addressed in the section below.

By embracing Green waste management strategies, we preserve our valuable natural resources. When natural resources are renewed at a greater rate than they are depleted, made possible through reduction, reuse and recycling practices and programs, we approach resource sustainability.

The following are resources that contain reuse/recycling guides that will assist you in identifying where, why, what, and how to reuse and recycle waste construction materials generated during the remodeling process.

The MN Pollution Control Agency (PCA) www.pca.state.mn.us
Recycling Association of Minnesota www.recycleminnesota.org/
Twin Cities Green Guide www.thegreenguide.org
Hennepin County www.hennepin.us
Eureka Recycling www.eurekarecycling.org/
Your local county and city reuse/recycling guides

The Deconstruction Process for Reuse and Recycling Strategies:

The deconstruction process occurs in the reverse order that the building was assembled. Finish materials come out first and generally have more value when reclaimed for reuse than structural components. They are the easiest to gain access to and require less labor to reclaim. As a rule they often had a higher value than structural components to begin with.

When deconstructing our buildings for reuse and recycling extra time and care must be taken to protect and separate materials. A small cost, that the public seems willing to accept, for adopting more sustainable practices that both reduce pollution and energy consumption.

[Thank You Sponsors - Together We Improve Homes & People's Lives](#)

9A -Construction and Demolition Waste

Construction waste adds up to 30% - 40% of all landfill waste and much of it can be reused or recycled with more sustainable results than sending it to the landfill.

For further information, see the NAHB Research Center's website www.nahbrc.org/ under Construction Waste, Best Practices.

9A-1_ Require subcontractors to participate in waste reduction and recycling efforts

Requirements:

- Provide a copy of contract or other commitment form to show how subcontractor is expected to participate in recycling efforts.
- Post a job-site recycling poster to clearly outline expectations and direction on what is to be done.

Exceptions:

- None

Rationale:

- Subcontractors can generate substantial amounts of waste. Making waste reduction and recycling a requirement will help transform it into standard operating procedure.

Considerations:

- None

Resources:

- TBD

9A-2_ Deconstruct for reuse the following items:

Requirements:

- Hire a non-profit or for profit entity to deconstruct and reclaim reusable materials from your site.
- If you deconstruct items for your own use in other projects you will need to inventory and take pictures to receive credit.

Exceptions:

- None

Rationale:

[Thank You Sponsors - Together We Improve Homes & People's Lives](#)

- When reclaiming materials for reuse take care to preserve the quality and reusability of the materials.
- Donate materials to non-profit organization or a for profit business.
- Reuse of natural resources that have already been harvested, processed, manufactured, and transported is the second most effective Green action because it keeps the embodied energy, already invested in these products, in use.
- Sell materials to a business or individual. Classified ads or sales through the Internet are several effective methods
- There are free markets via the Internet such as www.twincitiesfreemarket.com that are effective ways to give away items, as is the practice of setting out reusable items on your boulevard or near your alley with a free sign.

Considerations:

- Make sure deconstructed materials for reuse or resale do not contain asbestos, lead paint, mold, or other contaminants. Such materials must be disposed of at a hazardous waste dump or encapsulated in an appropriate manner.
- Test materials, which may be suspect, such as painted trim in homes older than 20 years (lead), pipes, which have a protective coating (asbestos), or visible mold.

Resources:

- None

Select all that apply:

9A-2a_ Cabinets, millwork, or trim (70% minimum)

Requirements:

- Identify outlet and arrange pick up or delivery.
- Remove as complete units and stage.

Exceptions:

- None

Rationale:

- There is a high demand especially for sets of quality cabinets and some period millwork/trim.

Considerations:

- Leaving debris in the wall assembly is a potential fire hazard.

Resources:

- None

[Thank You Sponsors - Together We Improve Homes & People's Lives](#)

9A-2b_ Wood flooring (minimum of 150 sq. ft.)

Requirements:

- Remove with care to protect the tongue and groove (provides stability when reinstalling).
- Identify outlet and arrange pick up or delivery.
- Remove and stage.

Exceptions:

- None

Rationale:

- There is good demand for this material.
- Old wood may be of higher quality than new
- It will blend in well with floors in older homes.

Considerations:

- The thickness of the floor above the tongue needs to be substantial enough to sand several times to make reuse worthwhile.

Resources:

- None

9A-2c_ Doors (minimum of 2)

Requirements:

- Remove as pre-hung or just the door.
- Include reusable hardware.

Exceptions:

- Significant alterations to the original size and character are detractions.
- Heavily painted or deteriorated doors that are beyond easy repair

Rationale:

- There is a significant demand for reusing of doors.
- Doors can also be used for other purposes such as tabletops and work benches

Considerations:

- None

[Thank You Sponsors - Together We Improve Homes & People's Lives](#)

Resources:

- None

9A-2d_ Bathtubs or sinks (minimum of 2)

Requirements:

- Identify outlet and arrange pick up or delivery.
- Remove and stage.

Exceptions:

- Identify outlet and arrange pick up or delivery.

Rationale:

- Old tubs are valued by some people, and if they are in good condition can easily last a long time.

Considerations:

- There is a limited market for sinks and bathtubs.
- Look for unique qualities like claw foot tubs, larger or smaller than 5', a specific architectural period, and sinks or bathtubs in exceptional condition.

Resources:

- None

9A-2e_ Dimensional lumber re-graded for structural use (minimum 20% landfill diversion)

Requirements:

- Most building inspectors require reused structural lumber to be re-graded or have the original stamp intact. There are also situations where it is not necessary to use stamped or re-graded lumber such as in non-structural applications.

Exceptions:

- None

Rationale:

- Dimensional lumber from the past can be of higher quality than new lumber and can often be reused on-site.
- Reuse on-site.
- Identify outlet and arrange pick up or delivery.
- Remove and stage.

[Thank You Sponsors - Together We Improve Homes & People's Lives](#)

Considerations:

- None

Resources:

- None

9A-2f_ Windows (minimum of 2)

Requirements:

- Identify outlet and arrange pick up or delivery.
- Remove as complete unit and stage or remove reusable parts and stage.

Exceptions:

- None

Rationale:

- Windows in good condition have value when reused in seasonal cabins or other buildings where energy efficiency is not a concern. Also windows being removed can be used for replacement parts when similar windows are remaining in use, on-site.

Considerations:

- Be sure to keep the seals intact. We do not want to promote the use of inefficient windows even if they are re-used. If the window should not be re-used, remove the glass for recycling and dispose of or repurpose the frames.

Resources:

- None

9A-2g_ Good condition carpet (50% minimum)

Requirements:

- Identify outlet and arrange pick up or delivery
- Roll up in large pieces (room size) and mark dimensions in a visible location

Exceptions:

- None

Rationale:

- Can be sold or given away if clean and in good condition.

Considerations:

[Thank You Sponsors - Together We Improve Homes & People's Lives](#)

- None

Resources:

- None

9A-2h_ Insulation (minimum of 50%)

Requirements:

- Reuse on-site

Exceptions:

- Certain types of insulation can be removed and sent or given away, such as expanded foam insulation shavings and blown-in cellulose insulation, where professional installers can accommodate hauling and recycling of material.

Rationale:

- It is best to reuse insulation on-site since the labor involved to move and protect it exceeds its initial or repurchase value
- It is possible to give away through Twin Cities Free Market

Considerations:

- Do not recycle insulation that contains mold

Resources:

- TBD

9A-2i_ Other: The above list represents some of the materials that can be reused and is not a complete list. If you reclaim other items for reuse not included in the list above submit them on this line.

9A-3_ Recycle the following:

Requirements:

- See below

Exceptions:

- None

Rationale:

[Thank You Sponsors - Together We Improve Homes & People's Lives](#)

- Recycling materials generated from the building process generally consumes less energy than producing new products from raw materials and is therefore a better option than sending waste to the landfill.

Considerations:

- None

Resources:

- None

Select all that apply:

9A-3a_ Packaging

Requirements:

- Identify outlet and arrange pick up or delivery.
- Remove and stage on appropriate day.
- Provide receipt

Exceptions:

- None

Rationale:

- Packaging such as plastic bag material and many types of paper have many residential and commercial outlets for recycling. Styrofoam has been difficult to recycle in the Twin Cities area but check the recycling guides for changes.

Considerations:

- None

Resources:

- TBD

9A-3b_ Workers' beverage containers

Requirements:

- Self-manage by placing a recycling bin on-site for plastic beverage containers. It will need to be labeled clearly and likely delivered to a recycling station or center.
- General contractor to sign-off on checklist

Exceptions:

[Thank You Sponsors - Together We Improve Homes & People's Lives](#)

- None

Rationale:

- Ask the homeowner if you can include your containers in their curbside service. Outlets are readily available, and there is no reason this cannot be easily achieved.
- An option is to encourage employees and subcontractors to take their beverage containers home to recycle in their curbside program.

Considerations:

- None

Resources:

- TBD

9A-3c_ Cardboard from new fixtures, appliances and cabinets (90% minimum)

Requirements:

- Check with homeowner to see if you can include with their curbside service if quantities are not too great.
- Identify outlet and arrange pick up or delivery.
- Remove and stage on appropriate day.
- Provide receipt

Exceptions:

- None

Rationale:

- Often cardboard can be used to protect existing finished materials, such as floors, and then recycled.

Considerations:

- None

Resources:

- TBD

9A-3d_ Semi-precious metals like copper, brass, lead and aluminum, and non-precious metals like steel, tin or sheet metal

Requirements:

- Identify outlet and arrange pick up or delivery.

[Thank You Sponsors - Together We Improve Homes & People's Lives](#)

- Combining the pick up of lesser value metals with the semi-precious metals will increase the chances of all being taken at one time. Separation of each type of metal will facilitate pick-up or acceptance if you self-deliver.
- Provide receipt.

Exceptions:

- None

Rationale:

- Metal recycling is well established and readily available. Check the Yellow Pages under Metal (Scrap)

Considerations:

- None

Resources:

- TBD

9A-3e_ Asphalt roofing (70% minimum)

Requirements:

- Identify outlet and arrange pick up or delivery.
- Provide receipt

Exceptions:

- None

Rationale:

- Asphalt shingles can be recycled.

Considerations:

- Finding someone who is willing to separate shingles may be difficult. Also, centers that accept shingles for recycling may be full and unable to accept additional material.

Resources:

- See the PCA Recycling Guide for further information, although supply may be greater than demand.

9A-3f_ Brick and block (70% minimum)

[Thank You Sponsors - Together We Improve Homes & People's Lives](#)

Requirements:

- Identify outlet and arrange pick up or delivery.
- Provide receipt.

Exceptions:

- None

Rationale:

- Both brick and block can be crushed for road fill if they are separated from other materials. Small quantities may be more difficult to find a hauler or recycling operation to accept. See MPCA Recycling Guide. Often brick can be reused on-site for patios or walks.

Considerations:

- None

Resources:

- TBD

9A-3g_ Drywall - grind or remove and recycle (70% minimum)

Requirements:

- Consult with professional gardener
- Identify outlet and arrange pick up or delivery.
- Provide receipt.

Exceptions:

- None

Rationale:

- On-site grinding of clean drywall may be practical when used as fertilizer. It should be treated as any fertilizer product and applied in the proper quantity where needed.

Considerations:

- Off-site recycling opportunities may be difficult to find now, but should become more available in the future.

Resources:

- TBD

9A-3h_ Carpet (70% minimum)

[Thank You Sponsors - Together We Improve Homes & People's Lives](#)

Requirements:

- Provide receipt.

Exceptions:

- None

Rationale:

- Most types of carpet are recyclable unless in very bad condition. The Carpet America Recovery Effort (CARE) is operating in the Twin Cities metro area.

Considerations:

- None

Resources:

- New carpet installers and the general public can recycle carpet by delivering it to specific recycling sites and following their criteria. See Eureka Recycling Guide at www.eurekarecycling.org/.

9A-3i_ Paints, primers, stains and sealants

Requirements:

- Homeowner to sign-off on checklist that materials have been left on-site and in a safe location.
- Provide receipt of drop-off to hazardous waste facility if materials are not left at job-site.

Exceptions:

- None

Rationale:

- Homeowners may wish to keep leftover materials for touch ups over time.
- Many counties have hazardous waste collection facilities to accept these types of materials.

Considerations:

- Be sure to place materials in a safe place away from combustion appliances.
- Water-based products will need to be kept from freezing.

Resources:

- See Eureka Recycling Guide www.eurekarecycling.org/, and the PCA site

[Thank You Sponsors - Together We Improve Homes & People's Lives](#)

www.pca.state.mn.us/oea/market/index.cfm has a section on what to do with paints and solvents

9A-3j_ Insulation

Requirements:

- Identify outlet and arrange pick up or delivery
- Provide receipt

Exceptions:

- None

Rationale:

- Almost anytime material can be reused or recycled, energy is saved in the production of new material.
- Cellulose and fiberglass insulation are the two most readily recycled insulation materials.

Considerations:

- None

Resources:

- www.ci.minneapolis.mn.us/solid-waste/what-to-do-l.asp#P40_1859

9A-3k_ Recycle or compost yard waste (minimum 90%)

Requirements:

- Provide receipt of general contractor to sign-off on checklist

Exceptions:

- None

Rationale:

- Eureka's Recycling Guide has a breakdown of who accepts the many yard waste items from land clearing.
- Yard waste (grass clippings and leaves) can be composted on-site. Most counties in the metro have compost sites.

Considerations:

- None

[Thank You Sponsors - Together We Improve Homes & People's Lives](#)

Resources:

- TBD

9A-3l_ Wood scrap and broken pallets (70% landfill diversion)

Requirements:

- Document means of diversion.
- Provide receipts

Exceptions:

- None

Rationale:

- There are companies all around the state that take pallets and recondition them for reuse.
- Clean wood can be mulched and used for a variety of applications including animal bedding and garden mulch.

Considerations:

- None

Resources:

- Type in “pallet recycling Minnesota” on a search engine to find sources for pallet recycling.

9A-3m_ Asphalt or concrete rubble (70% minimum)

Requirements:

- Separate concrete and asphalt.
- Receipt

Exceptions:

- None

Rationale:

- If separated, asphalt and concrete can be recycled.

Considerations:

- You will have to haul smaller quantities or hire someone to haul it for you.

Resources:

[Thank You Sponsors - Together We Improve Homes & People's Lives](#)

- The Eureka Recycling Guide www.eurekarecycling.org/ has a list of companies that accept asphalt and concrete to be recycled.

9A-4_ Grind wood waste and stumps and use as mulch (70% minimum)

Requirements:

- Grind and use on-site
- General contractor to sign-off on checklist

Exceptions:

- None

Rationale:

- 100% wood sheathing and lumber that is raw wood (e.g., no paint, stained, or treated wood) can be ground up on-site or sent to be ground up.
- Check recycling guides for opportunities off-site

Considerations:

- None

Resources:

- TBD

9A-5_ Composting portable toilet on job-site

Requirements:

- Provide photograph of unit.

Exceptions:

- None

Rationale:

- Composting toilets are readily available and do not use hazardous chemicals.

Considerations:

- None

Resources:

- A search on the Internet will help you find potential suppliers.

9A-6_ Obtain products from suppliers that use recyclable or reusable packaging

[Thank You Sponsors - Together We Improve Homes & People's Lives](#)

Requirements:

- Provide list of product used and type of packaging.

Exceptions:

Rationale:

- Reuse and recycling are both better strategies than disposal in a landfill.

Considerations:

- None

Resources:

- There are Green product guides on the PCA website www.pca.state.mn.us/oea/market/index.cfm, the Eureka website www.eureka recycling.org/, and other websites that have info on Green products and their packaging practices.

9A-7_ Reuse supplies for operations, such as construction fences, tarps, and refillable propane tanks

Requirements:

- Provide list of products reused.
- General contractor to sign-off on checklist

Exceptions:

Rationale:

- Reuse and recycling are both better strategies than disposal in a landfill for fences, tarps, etc.
- Use until worn out and then recycle if possible.

Considerations:

- None

Resources:

- TBD

9A-8_ Wash out concrete trucks in slab or pavement sub-base areas and provide appropriate clean up areas for other trades (e.g., paint or plaster)

[Thank You Sponsors - Together We Improve Homes & People's Lives](#)

Requirements:

- Instruct and inform subcontractors to abide by best practices.
- Photograph wash-out area

Exceptions:

- None

Rationale:

- Keeps waste in areas already prepped for concrete or uses best practices to prevent contamination of surrounding area by paint, plaster, etc.

Considerations:

- None

Resources:

- TBD

9A-9_ Building materials stored on-site are protected from weather exposure. Materials wetted during the construction process are allowed to dry before enclosing in building assembly.

Requirements:

- Set material off the ground on blocks.
- Cover to protect during the construction process, and if wetted, allow to dry before covering and using.
- Provide photograph of stored materials
- General contractor to sign-off on checklist stating materials were allowed to dry before enclosing in building assembly.

Exceptions:

- None

Rationale:

- Protecting materials onsite avoids unnecessary damage and increases life expectancy.

Considerations:

- None

Resources:

- None

[Thank You Sponsors - Together We Improve Homes & People's Lives](#)

9A-10_ Framing waste is less than 10% of total framing order

Requirements:

- Provide framing order from lumberyard that indicates the percent of waste factored into order

Exceptions:

- None

Rationale:

- Collaboration with a lumberyard on the goals of the project will help achieve a reduction in lumber sent to a job-site and potential wood that is sent to a landfill.
- This credit also requires that the contractor and framing carpenters collaborate on best methods to use less lumber.

Considerations:

- The use of a cut list can not only reduce waste, but also speed up the process of remodeling

Resources:

- TBD

9A-11_ Job-site framing plan and cut list

Requirements:

- Submit plan and cut list
- Central cut area - framing contractor shall use a central cutting area and store wood end cuts for reuse
- A plan shall be submitted that designates all structural framing for two of the following: floors, roof, and walls. The plan shall be reviewed with framing crew to ensure minimization of unnecessary framing.

Exceptions:

- None

Rationale:

- A framing plan cut list will maximize efficient use of framing materials

Considerations:

- None

[Thank You Sponsors - Together We Improve Homes & People's Lives](#)

Resources:

- None

9A-12_ Donate, sell or give away excess materials for reuse

Requirements:

- Describe materials and strategy used
- Provide receipts or General contractor to sign-off on checklist

Exceptions:

- None

Rationale:

- Excess or surplus materials, which are put to use helps prevent resource depletion, energy consumption and pollution. This saves processing of new products from raw materials.
- Identify outlet and arrange pick up or delivery
- Remove and stage

Considerations:

- None

Resources:

- TBD

9A-13_ Store and provide weather protection to building materials for future use by homeowner

Requirements:

- Set material off the ground on blocks.
- Cover with waterproof tarp, move inside or take other appropriate measures
- Provide photograph

Exceptions:

- None

Rationale:

- Proper protection of building materials for future use ensures their value and embodied energy is not wasted.

Considerations:

[Thank You Sponsors - Together We Improve Homes & People's Lives](#)

- None

Resources:

- TBD

9A-14_ Deconstruct existing structure and reuse or recycle approximately 90% of the building materials

Requirements:

- Create deconstruction materials list, track reuse and recycling of all materials.
- Provide receipts

Exceptions:

- None

Rationale:

- Deconstruction for reuse and recycling keeps more of the embodied energy of the deconstructed materials in use and is a more sustainable solution.

Considerations:

- Deconstruction takes time. Be sure to schedule accordingly

Resources:

- None

9B -Homeowner Waste Reduction

By providing the following systems and information to the homeowner the contractor can encourage responsible waste reduction practices long after the project is completed.

9B-1_ Install recycle center for homeowner use

Requirements:

- The remodeling contractor to provide site-built or commercially manufactured recycling containers for newspaper, glass, and at least one other material, if they are not provided by the city or municipality
- Builder shall provide the homeowner information on recycling facilities conveniently located to the homeowner as well as a list of haulers that provide curbside service if not provided by the city or municipality.
 1. General contractor to sign-off on checklist

[Thank You Sponsors - Together We Improve Homes & People's Lives](#)

Exceptions:

- None

Rationale:

- Providing space for and installing a recycling center encourages recycling by making it convenient, and sets an expectation which increases the likelihood of using the center for its intended purpose.

Considerations:

- None

Resources:

- TBD

9B-2_ Provide kitchen scrap compost bin and exterior compost bin

Requirements:

- Provide photograph of compost bins

Exceptions:

- None

Rationale:

- Food products not consumed can be composted on-site along with some yard waste, and used to improve the health of the soil on-site and reduce unnecessary landfill.
- Check with county extension agencies regarding the type of food scraps that can be composted.

Considerations:

- None

Resources:

- www.compostguide.com
- Contact counties or cities for information about how to compost successfully.

9B-3_ Recycle yard waste that cannot be composted

Requirements:

- Identify outlet and arrange pick up or delivery
- Remove and stage

[Thank You Sponsors - Together We Improve Homes & People's Lives](#)

Exceptions:

- None

Rationale:

- Most municipalities take yard waste, especially limbs, tree trunks, and trees that are not desirable to compost because of disease or other parasites.

Considerations:

- Some plant material is too large to recycle on-site, or has parasites or other diseases that should not be compost because of spreading the disease

Resources:

- Eureka Recycling Guide www.eurekarecycling.org/ has information on recycling yard waste that cannot be used on-site.

Collaboration is the key to the successful design, construction, and maintenance of a Green home. When all parties involved in the process are knowledgeable about the strategies and products employed in Green building, there is greater consensus to create the best solutions for the project. This means that all participants must be educated on a common definition of Green. The Minnesota GreenStar program provides a common language to discuss design, selections, systems and construction strategies. The voice of this program can help guide the education of subcontractors and vendors so that a common goal is understood and expectations are clearly outlined.

Once a home is remodeled Green, it is the effort of the occupants that will keep it functioning as a Green home over the lifespan of the building. Therefore, it is critical that homeowners understand the value of their Green home and the systems and products that were installed. They must have access to product specifications and maintenance schedules so that systems and products can be maintained to operate efficiently. The creation of a homeowner's manual places all the critical information in one, easy-to-access location. The manual takes the guesswork out of owning a home that contains many systems.

A homeowner's manual is also important in the sale of a property. It can serve as a marketing tool that outlines the unique features and benefits of the Green remodeled home. It is also important for helping a new occupant. Providing a sound education to the homeowner is the key to completing a successful Green remodeling project.

10 Education

Collaboration is the key to the successful design, construction, and maintenance of a Green home. When all parties involved in the process are knowledgeable about the strategies and

[Thank You Sponsors - Together We Improve Homes & People's Lives](#)

products employed in Green building, there is greater consensus to create the best solutions for the project. This means that all participants must be educated on a common definition of Green. The Minnesota GreenStar program provides a common language to discuss design, selections, systems and construction strategies. The voice of this program can help guide the education of subcontractors and vendors so that a common goal is understood and expectations are clearly outlined.

Once a home is remodeled Green, it is the effort of the occupants that will keep it functioning as a Green home over the lifespan of the building. Therefore, it is critical that homeowners understand the value of their Green home and the systems and products that were installed. They must have access to product specifications and maintenance schedules so that systems and products can be maintained to operate efficiently. The creation of a homeowner's manual places all the critical information in one, easy-to-access location. The manual takes the guesswork out of owning a home that contains many systems.

A homeowner's manual is also important in the sale of a property. It can serve as a marketing tool that outlines the unique features and benefits of the Green remodeled home. It is also important for helping a new occupant. Providing a sound education to the homeowner is the key to completing a successful Green remodeling project.

10PR -Prerequisites

10A -Homeowner and Subcontractor Education

10A-1_ Expand homeowner's user manual

Requirements:

- Provide additional home maintenance and lifestyle information beyond that listed in 10PR - 2. This can include, but is not limited to:
 - A site education packet covering alternatives to fertilizer and pesticide use, non-invasive plant species and irrigation systems operation
 - Occupant activities that positively impact a home including non-toxic cleaning products, non-toxic pest control measures, recycling and reuse measures, and composting methods

Exceptions:

- None

Rationale:

[Thank You Sponsors - Together We Improve Homes & People's Lives](#)

- A thorough explanation of how the products and systems of a home works helps to promote good maintenance practices and connects people to actions that lead to Greener lifestyle choices.

Considerations:

- None

Resources:

- TBD

10A-2_ Lead paint test performed

Requirements:

- There are lead test kits available for testing lead risk in the home, however, they are not always accurate and can't ensure user safety. It is highly recommended that a specialist trained to measure and assess lead risk be consulted prior to any handling of lead-based material.
- To find a contractor that has been trained to handle the abatement of lead in a safe manner, contact the National Lead Information Center (NLIC) at www.epa.gov/oppt/lead/pubs/nlic.htm or 1 (800) 424-5323
- If the lead risk is high in the home, occupants can be tested for lead levels in their blood

Exceptions:

- None

Rationale:

- Before 1978, the products found in and around our homes included the heavy metal, lead, as a component. Paint was one of the main housing products in which it was found. Chips of dry paint can contributor to lead poisoning along with the dust created by the disturbance of painted surfaces or soil contaminated by lead paint dust. Many negative health effects can occur from lead poisoning including behavioral problems, learning disabilities, seizures, and death.

Considerations:

- None

Resources:

- www.epa.gov/lead

10A-3_ Asbestos test performed

[Thank You Sponsors - Together We Improve Homes & People's Lives](#)

Requirements:

- Review the www.epa.gov/asbestos website for comprehensive information on asbestos risk, identification, and remediation.
- Contact the Minnesota Department of Health at (651) 201-4620, your local health department, or EPA regional offices for listings of licensed professionals in your area to identify, assess risk, and remove asbestos if necessary. It is not recommended that asbestos be removed by an inexperienced individual.

Exceptions:

- None

Rationale:

- Asbestos is a mineral fiber that was used in many housing products prior to the 1970s including duct insulation and gaskets, resilient floor tiles, their backing and adhesive, furnace and woodstove insulation, spray-on sound proofing, decorative wall and ceiling material, and asbestos-based cement roofing.
- When asbestos fibers become airborne due to damage or disturbance, they may be inhaled into the lungs where they can cause significant health problems. Several different types of cancer and lung tissue scarring are linked to asbestos fiber inhalation.

Considerations:

- None

Resources:

- TBD

10A-4_ Provide owners of home with two radon test kits designed for 48-hour exposures, including instructions for future use and guidance for follow-up actions to testing results

Requirements:

- Provide owners of home with two radon test kits designed for 48-hour exposures— instruct them to use one test kit six (6) months after construction and the other kit one (1) year after construction

Exceptions:

- None

Rationale:

- The entire state of Minnesota is in either a high or moderately high-risk zone for exposure to radon gas. Radon is a radioactive gas caused by the breakdown of the

[Thank You Sponsors - Together We Improve Homes & People's Lives](#)

element uranium naturally found in soil. It enters the home through cracks and holes in the foundation and slab and penetrations through walls.

- See Resources for more information about radon. Radon can become a problem in a home due to soil, slab, or foundation disturbance, even if the home tested at safe levels of radon prior to construction. Because of this, it is important to test for radon after construction and the settling of soils.

Considerations:

- None

Resources:

- www.epa.gov/radon
- Minnesota Department of Health, www.health.state.mn.us/index.html or (651) 201-5000.

10A-5_ Homeowner given a walk-through education during framing and upon final completion to explain design, construction and maintenance of their home

Requirements:

- Conduct a homeowner walk-through upon completion of framing explaining how and why the home is constructed, what stages will follow framing to reach completion and how and why they are preformed to achieve the desired results.
- Conduct a final walk-through to show how stages of construction process have been completed and how they need to be maintained and coordinated in order for the home to function properly.

Exceptions:

- None

Rationale:

- When verbal education is combined with visual and hands on education, homeowners will get a more complete understanding of the products and systems in their home.
- Repeating information through multiple educational sessions is critical for retention of information, especially when there can be many systems involved in a home.

Considerations:

- None

Resources:

- TBD

[Thank You Sponsors - Together We Improve Homes & People's Lives](#)

11 Innovation

Building homes to make them more efficient and durable is an evolving process and can be achieved in many different ways. This section provides a place to receive credit for alternative products, installations procedures, and the systems they create which are not already included in previous sections.

11PR -Prerequisites

11A- Performance Design and Alternative Methods

11A-1_ Trees removed for construction are milled and incorporated in the project

Requirements:

- List tree species and intended end use of wood
- Photograph if possible

Exceptions:

- None

Rationale:

- Use of local materials significantly reduces negative affects caused by long distance transportation.
- Consider using lumber for flooring, millwork, paneling, and cabinetry.

Considerations:

- Depending on the method used for drying the lumber, a wait period of 4 months may be required before using the material. Air dried wood, while taking longer to dry, uses considerably less energy and should be strongly considered

Resources:

- TBD

11A-2_ Use alternative building systems (e.g., Durasol, Fasswall, Autoclaved Aerated Concrete)

Requirements:

[Thank You Sponsors - Together We Improve Homes & People's Lives](#)

- Walls must be installed according to manufacturer's specifications
- A minimum of 80% of above grade exterior area shall be precast and autoclaved aerated concrete.
- Rater verifies

Exceptions:

- None

Rationale:

- While these systems may sound new, they have been in existence for many years. They all have a mission of combining structure and insulation in one step to reduce installation time and costs as well as to improve air sealing and energy efficiency.

Considerations:

- None

Resources:

- www.aacpa.org/

11A-3_ Cold climate appropriate natural building system (e.g., straw bale, cordwood)

Requirements:

- Provide plan and rationale to illustrate method and compatibility with Minnesota's climate.
- Documentation will depend upon methods used.

Exceptions:

- None

Rationale:

- There are many natural building systems that are making a come back, and should be paid attention to. Some are more appropriate to our climate and weather than others. A home made of rammed earth is an excellent building method in dry climates, but not so great in an area that may see many feet of snow. We encourage the exploration and re-introduction of these building techniques provided they make sense in Minnesota.

Considerations:

- None

Resources:

- TBD

[Thank You Sponsors - Together We Improve Homes & People's Lives](#)

11A-4_ Unique partnerships formed to advance resource efficient building

Requirements:

- Provide overview of partnership and illustrate how it achieves the criteria

Exceptions:

- None

Rationale:

- There are countless ways to explore and advance resource efficient building in any specific community or area.

Considerations:

- None

Resources:

- TBD

11A-5_ Air, moisture and insulation all kept to the exterior of the structure - persist method

Requirements:

- The PERSIST (Pressure Equalized Rain Screen Insulated Structure Technique) method is one example where the air and moisture barrier are at the exterior of the building envelope rather than enclosing the insulation within the building cavity.
- Provide proof of implementation
- Provide photographs of system
- Rater verification

Exceptions:

- None

Rationale:

- Prevents penetration of air and moisture into the building cavity in order to encourage long-term building durability.
- This process was developed specifically for cold climate buildings.
- The roof and walls are sealed with a membrane on the exterior of the sheathing (vapor barrier). All the insulation is exterior to the vapor barrier. The area between the studs becomes part of the conditioned space of the building envelope. Any penetrations through interior sheetrock (e.g., hangers for pictures and art) or within the studs (e.g., electrical wiring) is within the building envelope.

[Thank You Sponsors - Together We Improve Homes & People's Lives](#)

Considerations:

- None

Resources:

- www.cchrc.org/Reports/REMOTE%208-2-06.pdf
- www.homeenergy.org/archive/hem.dis.anl.gov/eehem/99/991108.html

11A-6_ American Lung Association Health House

Requirements:

- Show certification by ALAHH

Exceptions:

- None

Rationale:

- Proven to reduce health risks in the home.

Considerations:

- None

Resources:

- TBD

11A-8_ Abate asbestos from home

Requirements:

- Hire licensed asbestos abatement company
- Provide receipt for proof

Exceptions:

- None

Rationale:

- Removing asbestos from the home eliminates the risk of exposure.

Considerations:

- Only licensed professionals should abate asbestos

[Thank You Sponsors - Together We Improve Homes & People's Lives](#)

Resources:

- TBD

11B -Design for Reduced Electrical and Magnetic Fields

The recommendations here are based upon safe exposure guidelines accepted by regulatory agencies, particularly in Europe, dedicated to protecting human health from harmful exposure to man-made electrical and magnetic fields (EMF) as well as radio frequencies (RF). The information here may be viewed as controversial since the primary data pointing to concern is coming from Europe. Yet, health researchers in the United States are actively pursuing research in this area.

In fact, the BioInitiative Report (www.bioinitiative.org) was published by the State University of New York in Albany, in August 2007. Twelve experts from around the world reviewed over 2,000 studies on the health risks of exposure to EMFs. They came to the conclusion that the EMF exposure limits set by government regulatory agencies in this country are, in their opinion, thousands of times too lenient, based upon their review of the scientific literature. They state that the harmful effects are cumulative and occur even at exposure levels too low to cause tissue heating, which have up until now been thought to be safe.

Based upon the release of this report, and a similar study in England that could not rule out cancer with the use of cell phones, the European Union's (EU) European Environmental Agency, equivalent to our EPA, and the German government have both recommended to their citizens that they reduce their exposure to cell phones, cell towers and Wi-Fi (wireless Internet) until safety can be established. They favor cable-based alternatives for high speed Internet networks in buildings, a recommendation included below. The BioInitiative Report also cautions against exposure to cordless telephones, because the harmful effects from wireless exposure is cumulative and people spend hours on them per week. Exposure to magnetic fields from electric wiring and appliances in homes was also discussed in the BioInitiative Report, and was found to be harmful.

Technology use in the United States is changing so rapidly that past research may not be a reliable predictor of risk. Past research was not conducted on current frequency of use and quantity of exposure. The number of cellular telephone users and length of time in which a cell phone is in contact with our bodies—whether attached to our bodies via hip belts, purses, pockets, wireless ear pieces, or headphones—is growing rapidly. Wireless computer networks can be found in homes, at work, in coffee shops, and libraries. EMFs surround us via broadcast antennas for radio and TV transmission, pagers, cordless phones, satellite communications, and many manufacturing processes.

Because EMF exposure has potential links to headaches, ear and eye problems, memory problems, sleep disturbance (and the physical ailments that come from sleep deprivation), and

[Thank You Sponsors - Together We Improve Homes & People's Lives](#)

cancer, we are using what is called the “precautionary principle”— if there is sufficient evidence that there could be harm from exposure to an influence and that exposure cannot be proven to be safe beyond a shadow of a doubt, then precautions need to be taken by the public to protect human exposure to that influence until safety can be firmly established.

Although the majority of the population states that they cannot feel the influence of EMF (Electrical and Magnetic Fields) exposure, there are people who are highly sensitive—experiencing health issues caused by EMFs. Studies are even showing that the asymptomatic spouses and family members (those without symptoms) of symptomatic individuals report improvement in their health after changes are made to their homes.

These guidelines are intended to add a dedicated grounding system to a home. This will help reduce occupant exposure to unhealthy magnetic field exposure caused by electric current on metal water pipes and existing grounding conductors. Under normal conditions, metal pipes and grounding conductors should not be carrying electric current. If typical grounding practices are followed, electrical current from other homes in a neighborhood may be entering your own home through the grounding system or water pipes. To avoid this, we recommend the installation of copper alternative water service supply pipe to the street, such as PEX or ABS.

Magnetic field exposure also occurs from proximity to point sources, such as electric motors and transformers. We generally recommend maintaining a distance of 6’ from these devices. Steps are also recommended to reduce nighttime exposure to unhealthy electric fields, particularly in sleeping areas. This type of EMF is produced by unshielded non-metallic (NM or Romex) wiring in walls and floors and unshielded AC power cords. This type of EMF is known to disrupt sleep.

Sleep could also be disrupted by exposure to an ungrounded refrigerator, in-floor electric heating systems (where the hot and neutral conductors are separated), low-voltage transformers (such as your digital clock radio), and compact fluorescent fixtures. Healthier alternatives are suggested, and we recommend you be aware of how proper placement can reduce risk, because magnetic and electric fields penetrate walls and floors.

11B-1_ Improvements to existing grounding of electrical service to main water supply (pre-existing conditions also qualify)

Select one:

- 11B-1a** Install polyethylene pipe for water service supply pipe underground
- 11B-1b** Install insulated, dedicated wire, or bare copper wire in plastic conduit, as new “Service” grounding conductor from main electric panel to point of entry of metal water service supply pipe before (below) water meter.

11B-1a_ Install polyethylene pipe for water service supply pipe underground

[Thank You Sponsors - Together We Improve Homes & People's Lives](#)

Requirements:

- Provide a photograph of installation

Exceptions:

- None

Rationale:

- Prevents electric current on metal grounding conductor, metal pipes and other paths that can cause magnetic field exposure for occupants.

Considerations:

- None

Resources:

- TBD

11B-1b_ Install insulated, dedicated wire, or bare copper wire in plastic conduit, as new “service” grounding conductor from main electric panel to point of entry of metal water service supply pipe before (below) water meter

Requirements:

- Use four or six gauge copper (depending upon size of panel).
- Route this conductor low down on basement wall along periphery of house, as far away from upstairs sleeping, sitting, and kitchen areas as possible (will carry current).
- Leave previously existing grounding conductor to be used as “Equipment” ground, which will not normally conduct electricity (see next item).
- Avoid direct contact between “System” grounding conductor and concrete wall. If “System” grounding conductor runs in attic of garage and through house, avoid high traffic areas (e.g., kitchen, bedrooms).
- Verify that service drop neutral is intact. Then install dielectric union in water service supply pipe after (above) water meter and before first branch of pipe. If no room is available before first branch, install dielectric union in each branch. Verify presence of a separate grounding conductor from main electric panel to water service supply pipe that is clamped after (above) dielectric union. Serves as “Equipment” ground. Can be un-insulated copper wire. Can use existing grounding conductor, but do not continue this conductor and clamp below dielectric union. “Equipment” ground will not carry electric current under normal conditions (as long as it is not clamped below dielectric union), so it is safe to run this conductor through occupied areas. (Reason for dielectric union: Eliminates current on metal domestic water pipes within house and on “Equipment” grounding conductor. Both can cause magnetic field exposure for

[Thank You Sponsors - Together We Improve Homes & People's Lives](#)

occupants. Puts 100% of current onto new insulated “System” grounding conductor to be located away from occupied areas - see diagram above, “House Electrical: Equipment (Water Pipes) and System Grounding Configuration,” and diagram below, “The Two Types of Grounding: Definitions and Functions.”)

- Electrical contractor to sign-off on checklist

Exceptions:

- None

Rationale:

- Electric current presently runs on metal grounding conductor that can cause unhealthy magnetic field exposure for occupants, even ten to twenty feet away. This protocol isolates this hazard. Also, concrete foundation conducts electricity.) (See diagram below, “House Electrical: Equipment (Water Pipes) and System Grounding Configuration.”)

[Thank You Sponsors - Together We Improve Homes & People's Lives](#)

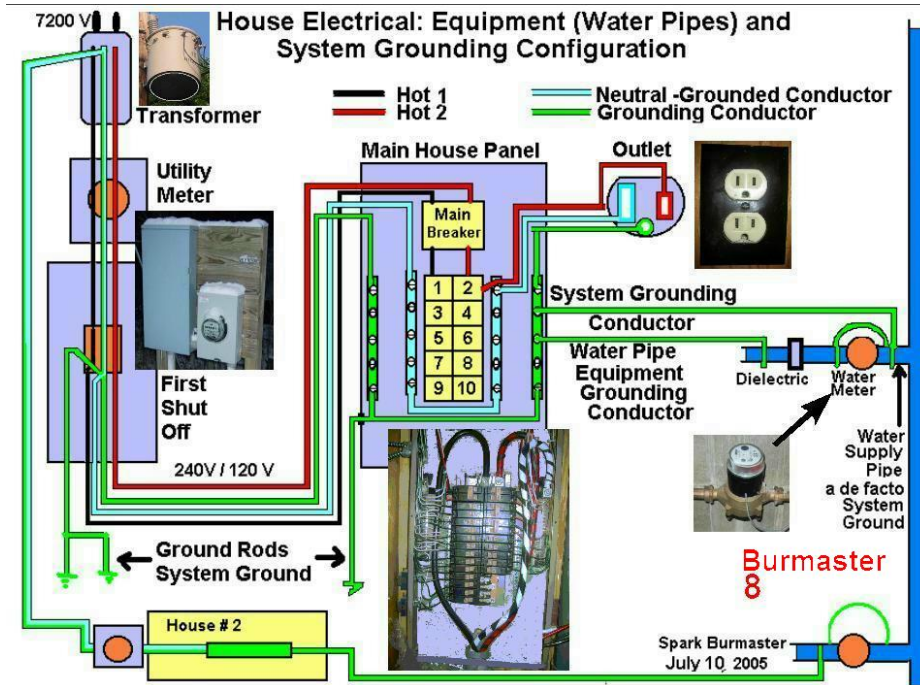

Thank You Sponsors - Together We Improve Homes & People's Lives

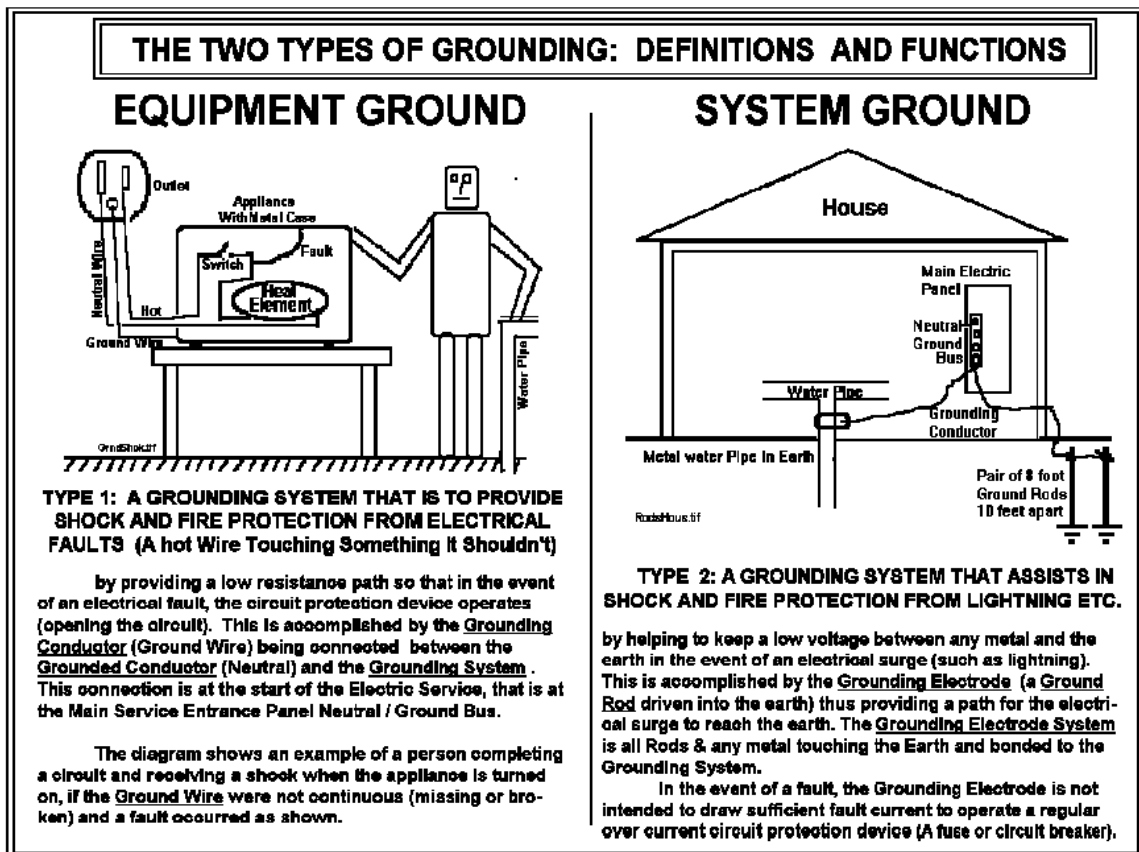

Jan 18, 2000 S. Burnmaster GmdType.wpd

Considerations:

- None

Resources:

- TBD

11B-2_ Install Ufer ground that does NOT contribute to widespread Electro Magnetic Fields (EMF) in home

Select one:

- 11B-2a_** Install dedicated steel #4 rebar ground rod embedded in concrete footing and stubbed out for connection to electrical panel ground wire. 20' minimum rebar length and CANNOT touch other rebar.

[Thank You Sponsors - Together We Improve Homes & People's Lives](#)

- 11B-2b_** Install dedicated steel #4 rebar grounding rod embedded in separate concrete caisson and stubbed out for connection to electrical panel ground wire.
20' minimum rebar length.

Requirements:

- 11B-2a. Install a steel #4 rebar in house footing as described in credit language above. Rebar must be a single continuous bar of 20' length minimum.
 - Preventing Ufer grounding rebar from touching any other rebar is the key to this installation option.
 - Notes on drawings and/or specifications indicating work to be done.
 - Pre-backfill photo—OR—rater verification.
- 11B-2b. Install a steel #4 rebar in separate concrete caisson as described in credit language above. Rebar must be a single continuous bar of 20' length minimum.
 - Caisson to be 3' from house foundation minimum.
 - Notes on drawings and/or specifications indicating work to be done.
 - Pre-backfill photo—OR—rater verification

[Thank You Sponsors - Together We Improve Homes & People's Lives](#)

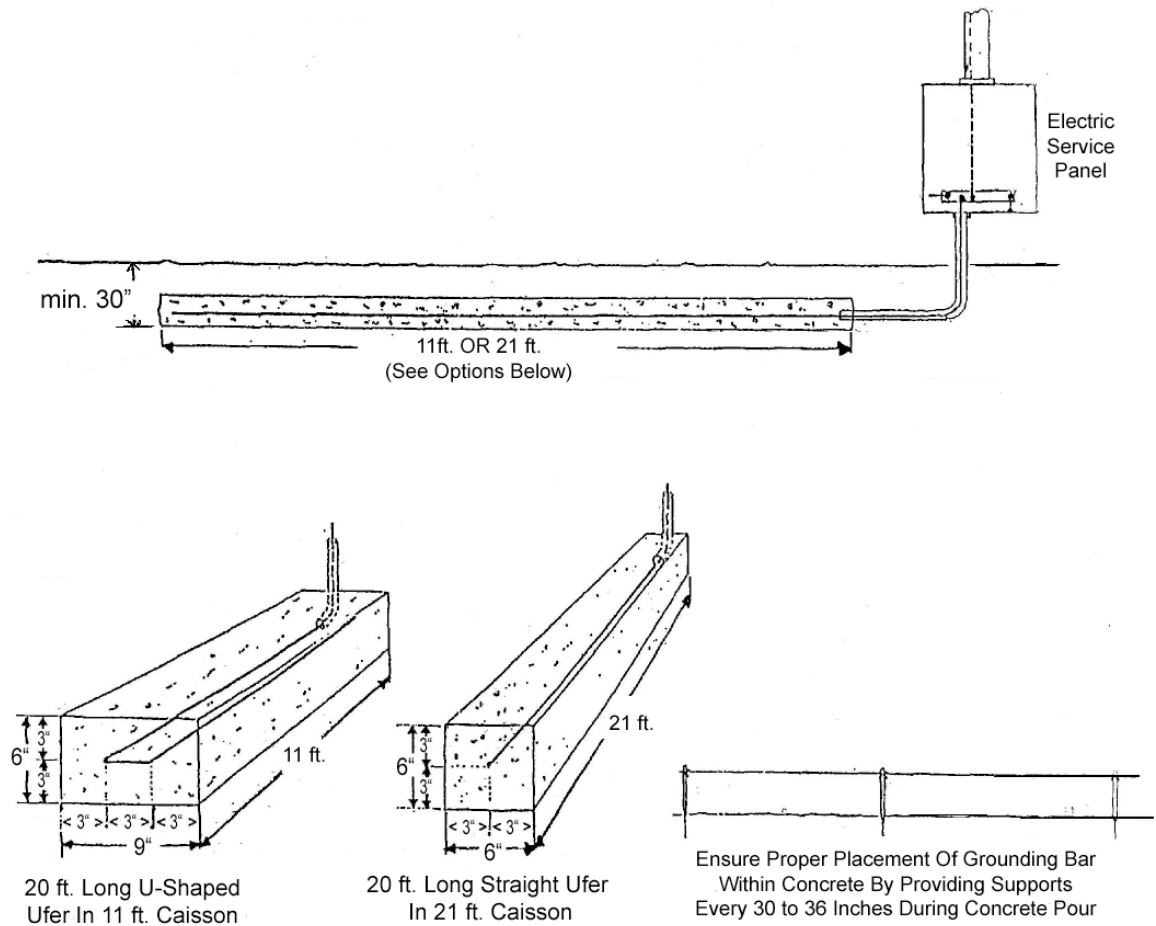

Exceptions:

- None

Rationale:

- A Ufer ground describes one in which the grounding conductor is embedded in buried concrete. This is typically an effective way to ground the electrical system in a building, especially in dry conditions where stand-alone grounding rods are not effective. Often, a Ufer ground is installed by connecting the ground wire from the electrical service panel of the house to the entire network of metal rebar that is in the footing, foundation, and slab. This can result in widespread electro magnetic fields in the home, which are generally better to avoid, especially for highly sensitive individuals.

[Thank You Sponsors - Together We Improve Homes & People's Lives](#)

- The alternate Ufer ground installations described here minimize (4B-13a) or eliminate (4B-13b) the potential for electro magnetic fields being created in the home due to the use of a Ufer ground.

Considerations:

- To prevent a potential delay during construction, prior approval from electrical inspector may be advisable—especially if installing a separate caisson-type Ufer ground. Not all electrical inspectors are familiar with this method.
- At least one example of the separate caisson-type Ufer ground has been installed and approved in Minnesota as of the date this document was written.

Resources:

- TBD

11B-3_ Ground electrical panel to approved dedicated “Hammered-in” ground stake (not rebar, plumbing pipes, or any integral part of the house)

Requirements:

- If contractor plans to provide a stub out from metal rebar in basement slab or footer as a Ufer ground to main electric panel as primary ground (if no metal water pipe is present), bond to a concrete-encased 20’ section of metal rebar in separate caisson buried 3’ or more away from the foundation. Electrical code inspectors in Minnesota have approved installing a separate caisson outside the foundation if no stub out exists from footer.
- Avoid metal water service supply pipe. Use copper alternative (PEX or ABS) (see 11B-1a)

Exceptions:

- None

Rationale:

- If ground conditions are appropriate, a grounding stake can provide effective grounding for the electrical service panel.
- Prevents distribution of electric current onto the entire rebar of the building. Minnesota electrical code does not require connecting piece of rebar used as Ufer ground with rest of rebar.

Considerations:

- See the introduction to Section 11 for more information about electro magnetic fields.
- Consult with electrical inspector to get approval for electrical service panel grounding strategy.

[Thank You Sponsors - Together We Improve Homes & People's Lives](#)

Resources:

- See “CONCRETE-ENCASED ELECTRODE REQUIREMENT: CLARIFIED,” Fall 2005 Department of Labor and Industry Electrical Licensing and Inspection Newsletter, Page 6, www.electricity.state.mn.us/pdf/eli_fall05.pdf)

11B-4_ Wiring run in metal conduit (low voltage exempt)

Select one:

- 11B-4a_** All wiring within 6’ of a bed is run in metal conduit (flexible and rigid qualify)
- 11B-4b_** All electrical wiring in whole house run in metal conduit (flexible and rigid qualify)

Requirements:

- Electrical contractor to sign-off on checklist

Exceptions:

- Low voltage exempt.

Rationale:

- Metal conduit helps shield occupants of the home from electro magnetic fields.
- Use of metal conduit also provides added durability protection from electrical fires caused by wire shorting out or physical damage to wires when hanging photos, etc.
- Sleeping areas are the most critical ones where EMFs should be avoided.

Considerations:

- See the introduction to Section 11 for more information about electro magnetic fields.

Resources:

- TBD

11B-5_ Proper sub-panels supplied by four-wire cable, where neutral and ground conductors are not connected

Requirements:

- Three-wire cable puts current on the grounding system, causing magnetic field exposure from parallel return paths of current flow.)
- All sub-panels are to be supplied by four-wire cable, per NEC.

[Thank You Sponsors - Together We Improve Homes & People's Lives](#)

- All sub-panels are to be wired such that neutral and ground conductors are not connected, per NEC. (Reason: Prevents magnetic field exposure from current on the grounding system.)
- Choose brands of electric panel that allow connecting neutral conductors to a neutral bus alongside the connection of the corresponding hot conductor to its breaker. Twist the neutral and hot conductors from their point of entry into the electric panel to their connection to the bus and breaker to avoid separating the hot from the neutral conductors. This reduces magnetic field exposure from the electric panel. (Reason: Reduces magnetic field exposure from separation of branch hot conductors from branch neutral conductors.) (See photos.)
- Mount the electric panel so that incoming hot and neutral service cables connect directly to lugs. If service cables enter from underneath, turn panel upside down. Avoid running service cables up sides of breakers from bottom of panel box to lugs at top. (Reason: Reduces magnetic field exposure from separation of hot conductors from neutral conductor.) See photos.
- Electrical contractor to sign-off on checklist



Right



Wrong

Exceptions:

- None

Rationale:

- None

Considerations:

[Thank You Sponsors - Together We Improve Homes & People's Lives](#)

- None

Resources:

- TBD

11B-6_ Keep electrical service connection, electric meters, and panels at least 10' from sleeping areas (this credit was in NHC)

Requirements:

- Electrical contractor to sign-off on checklist

Exceptions:

- None

Rationale:

- Prevents magnetic field exposure for occupants. Occupants should not sleep within 6' of exterior wall at point of connection of outside overhead electric service.
- Reduces large magnetic field exposure for occupants due to separation of hot conductors from neutral conductor outside exterior wall at weather head.

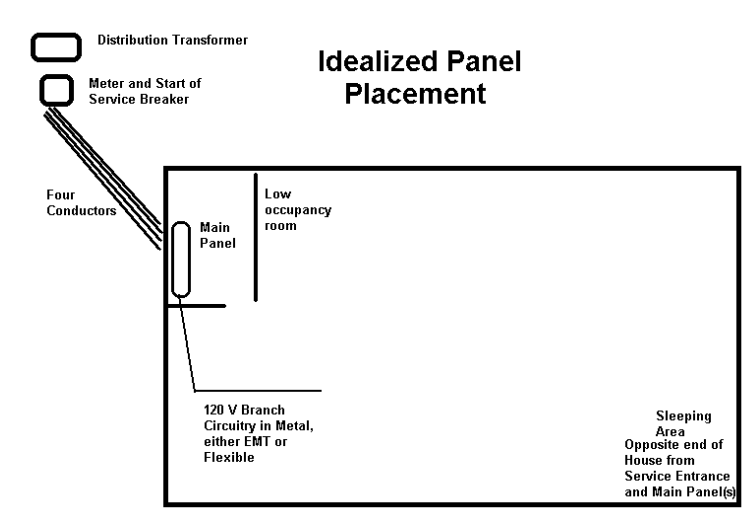

Considerations:

- See the introduction to Section 11 for more information about electro magnetic fields.

Resources:

- TBD

[Thank You Sponsors - Together We Improve Homes & People's Lives](#)

11B-7_ No fluorescent light fixtures, or transformers for halogen lighting systems in ceiling beneath a child's bedroom, or within 6' of a sleeping area

Requirements:

- Avoid installing transformers for halogen lighting systems within 6'-10' of occupant sleeping or sitting areas.
- Electrical contractor to sign-off on checklist

Exceptions:

- None

Rationale:

- Avoids magnetic field exposure for sleeping child when fluorescent light is turned on underneath bedroom. Prevents magnetic field exposure from transformer.

Considerations:

- None

Resources:

- TBD

11B-8_ Electric in-floor radiant heat carries hot and neutral conductors in same cable (dual conductor cable) and is located at least 6' away from sleeping areas

Requirements:

- Do not install electric in-floor radiant heaters with single wire conductors
- Electrical contractor to sign-off on checklist

Exceptions:

- None

Rationale:

- Prevents significant magnetic field exposure when heater is turned on because single hot conductors are separated from one another. Conductors therefore do not cancel the magnetic flux in one another. (Hydronic in-floor radiant heating systems create no significant magnetic, or electric, field exposure.)
- Electric in-floor radiant heaters with dual conductors are under review and may be acceptable (e.g., Warm Zone Danfoss LX Mats with “dual conductor heating cable”, www.warmzone.com/under-floor-heat.asp) as long as they are 240 Volt since they prevent significant magnetic field exposure when heater is turned on because dual

[Thank You Sponsors - Together We Improve Homes & People's Lives](#)

conductors place outgoing and incoming hot conductors immediately next to each other, avoiding separation of conductors. This cancels magnetic flux in adjoining conductors. Also, 120 Volt conductors cause electric field exposure—see below.

Considerations:

- None

Resources:

- TBD

11B-9_ Wall-mounted electric heaters are installed at least 6' away from sleeping area

Requirements:

- Install 240 Volt units rather than 120 Volt units. (Reason: Avoids electric field exposure—see below. Electric fields are neutralized in each 120 Volt conductor when in close proximity in 240 Volt circuits).
- Electrical contractor to sign-off on checklist

Exceptions:

- Wall-mounted electric heaters can be used but install at least 6' away from sleeping area.

Rationale:

- Prevents significant magnetic field exposure when heater is turned on

Considerations:

- None

Resources:

- TBD

11B-10_ Install dedicated circuit with shut-off switch for all outlets that will have constant-draw machines outside of media rooms (media rooms are covered under 4A-7)

Requirements:

- Install dedicated circuit with shut-off switch for all outlets that will have constant-draw machines outside of media rooms (media rooms are covered under 4A-7)
- Install metal clad wiring in areas around, above and below sleeping areas, within 10' of the bed. Install a shut-off switch for all outlets within this radius. (Reason: Reduces occupant exposure to 120 Volt-induced electrostatic field exposure while sleeping.)
- Electrical contractor to sign-off on checklist

[Thank You Sponsors - Together We Improve Homes & People's Lives](#)

Exceptions:

- None

Rationale:

- Ghosting appliances are responsible for considerable energy consumption. This strategy is credited under energy efficiency in the Electrical section. Additional benefit potential for EMF sensitive individuals and subsequent IEQ credits are available for the remodeler working with a sensitive client. Up to two (2) IEQ credits may be obtained (one for each additional room).

Considerations:

- None

Resources:

- None

11B-11_ Provide a shut-off switch for all non-metallic (NM) circuits within 10' of sleeping area. Run metal-clad wiring for all smoke detectors in bedrooms on independent circuits.

Requirements:

- Smoke detectors must be hardwired and may not be connected to a shut-off switch.
- If non-metallic (NM) plastic-jacketed wiring is installed in bedroom walls, floors, and ceilings, provide a shut-off switch for all NM circuits within 10' of the bed (9B-10). Install CAT-5 or CAT-6 shielded data cable throughout house to every room where computers will be used
- Electrical contractor to sign-off on checklist

Exceptions:

- None

Rationale:

- Reduces occupant exposure to 120 Volt-induced electrostatic field exposure while sleeping.

Considerations:

- None

Resources:

- TBD
-

[Thank You Sponsors - Together We Improve Homes & People's Lives](#)

11B-12_ Install CAT-5e (enhanced) or CAT-6 shielded data cable throughout house to every room where computers and telephones will be used. Avoid Wi-Fi. Use hardwired, corded telephones rather than cordless telephones.

Requirements:

- Provide photograph
- Electrical contractor to sign-off on checklist

Exceptions:

- None

Rationale:

- Some homeowners are sensitive to radio frequencies emitted by wireless routers.
- Provides hardwired smart wiring for telephone and high speed Internet connections.
- Allows homeowner to avoid using wireless Internet routers.
- CAT-5e handles speeds as high as 100 mbps

Considerations:

- None

Resources:

- TBD

11B-13_ Do not run coolant or power lines to air conditioner compressor motors within 10' of sleeping area

Requirements:

- General contractor to sign-off on checklist

Exceptions:

- None

Rationale:

- Reduces large magnetic field exposure for occupants

Considerations:

- None

Resources:

- TBD

[Thank You Sponsors - Together We Improve Homes & People's Lives](#)

11B-14_ Refrigerator is not located within 6' of sleeping area

Requirements:

- General contractor to sign-off on checklist

Exceptions:

- None

Rationale:

- Reduces large magnetic field exposure for occupants from compressor motor.

Considerations:

- None

Resources:

- TBD

11B-15_ Install alternative to electronic dimmer light switches (e.g., on/off switch or 3-way bulb that switches from 50 to 100 to 150 watt)

Requirements:

- Provide a lighting plan with details regarding light reduction strategies
- Electrical contractor to sign-off on checklist

Exceptions:

- None

Rationale:

- Reduces EMFs

Considerations:

- None

Resources:

- TBD

11C -Innovative Design

11C-1_ Documentation and justification are required in order to receive consideration for innovation points

[Thank You Sponsors - Together We Improve Homes & People's Lives](#)

Requirements:

- Provide appropriate documentation to prove that the measure has been implemented or installed, in order to be considered for points in this section. This could include but is not limited to:
 - Signatures from homeowners, sub-contractors, contractor
 - Calculations
 - Material specifications
 - Rater verification
 - Photographs
 - Research from manufacturers
- Write the innovation credit as if it was to be adopted into the GreenStar program and include:
 - Requirements
 - Exceptions
 - Rationale
 - Considerations
 - Resources

Exceptions:

- Credits being sought cannot be itemized in other locations of this manual
- Provide any exceptions to the usage of the innovation credit in new construction.

Rationale:

- New products, methods of installation, technologies, and systems are being developed and experimented with every day. As long as the results from these efforts create a Greener home this program will consider them for inclusion in this section and possibly incorporate them into previous sections, as they become common practices.
- In-depth documentation provides integrity to the idea and system to prevent greenwashing or the promotion of an idea or technology that is not really Green.

Considerations:

- New and innovative materials and processes are just that—new and innovative. This means that they may have not had time on the market or in research and development before being thoroughly tested. Therefore, there is a risk with trying new material, methods, processes and the like. As a general rule, most experiments fail. It is up to the individual applying the innovation to determine its applicability and level of risk.

Resources:

- TBD

[Thank You Sponsors - Together We Improve Homes & People's Lives](#)

11C-2_ Documentation and justification are required in order to receive consideration for innovation points (see 11C-1)

11C-3_ Documentation and justification are required in order to receive consideration for innovation points (see 11C-1)

[Thank You Sponsors - Together We Improve Homes & People's Lives](#)